

Serie 9000

 9200 Pag. 16.8	 9220 Pag. 16.8	 9230 Pag. 16.8	 9260 Pag. 16.8	 9280 Pag. 16.9	 9460 Pag. 16.9	 9480 Pag. 16.9	 9500 Pag. 16.9	 9550 Pag. 16.10	
 9680 Pag. 16.10	 9740 Pag. 16.10	 10770 Pag. 16.10							

Serie 10000

Fino ad esaurimento scorte - Until the end stock - Nur solange vorrat
 Livrable jusqu'à épuisement du stock - Hasta fin de stock - Ate fim do stock

 10200 Pag. 16.14	 10220 Pag. 16.14	 10230 Pag. 16.14	 10240 Pag. 16.15	 10260 Pag. 16.15	 10280 Pag. 16.15	 10290 Pag. 16.16	 10460 Pag. 16.16	 10465 Pag. 16.16
 10480 Pag. 16.17	 10485 Pag. 16.17	 10500 Pag. 16.18	 10510 Pag. 16.18	 10550 Pag. 16.19	 10680 Pag. 16.19	 10760 Pag. 16.19		

Serie 13000

 13200 Pag. 16.23	 13220 Pag. 16.23	 13230 Pag. 16.23	 13240 Pag. 16.24	 13260 Pag. 16.24	 13280 Pag. 16.24	 13290 Pag. 16.25	 13300 Pag. 16.25	 13460 Pag. 16.25
 13465 Pag. 16.26	 13480 Pag. 16.26	 13483 Pag. 16.26	 13485 Pag. 16.27	 13500 Pag. 16.27	 13510 Pag. 16.27	 13530 Pag. 16.28	 13540 Pag. 16.28	 13550 Pag. 16.28
 13550BI Pag. 16.29	 13570BI Pag. 16.29	 13958BI Pag. 16.29	 13600 Pag. 16.30	 13680 Pag. 16.30	 13740 Pag. 16.30	 13780 Pag. 16.30	 10740 Pag. 16.31	 10770 Pag. 16.31
 1612 Pag. 16.31	 1613 Pag. 16.31	 13800 Pag. 16.32	 13805 Pag. 16.33	 13810 Pag. 16.33	 13820 Pag. 16.34	 13825 Pag. 16.34	 TBPL Pag. 16.35	

RACCORDI UNIVERSALI A BICONO

UNIVERSAL DOUBLE CONE FITTINGS

DOPPELKEGEL VERSCHRAUBUNGEN

RACCORDS UNIVERSELS A DOUBLE CONE

RACORDAJE UNIVERSAL A BICONO

CONEXÕES UNIVERSAIS DE CONE DUPLO

Fino ad esaurimento scorte

Until the end stock

Nur solange vorrat

Livrable jusqu'à épuisement du stock

Hasta fin de stock

Ate fim do stock



CARATTERISTICHE TECNICHE

TECHNICAL CHARACTERISTICS
TECHNISCHE ANGABEN
CARACTÉRISTIQUES TECHNIQUES
CARACTERÍSTICAS TÉCNICAS
CARACTERÍSTICAS TÉCNICAS

Norma di Riferimento

Reference standard

Entspricht der Norm

Norme de référence

Normativa de referencia

Norma de referência

1907/2006

REACH ✓

2011/65/CE

RoHS ✓

PED

2014/68/UE

SILICON

FREE

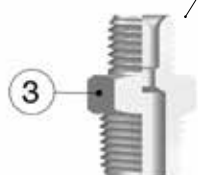

Sede e bicono a norma DIN 3862.
Seat and olive in conformity with
DIN Standards 3862.
Ein Registriert unter DIN 3862 Bicone.
Un enregistré en application DIN 3862 bicone.
Sede y bicono a norma DIN 3861.
Sede e bucha conforme Norma DIN 3862.



Rinforzo Art. 10770.
Internal support bush Art. 10770.
Verstärkung Art. 10770.
Renforcement Art. 10770.
Refuerzo Art. 10770.
Bucha de reforço interno Cód. 10770.

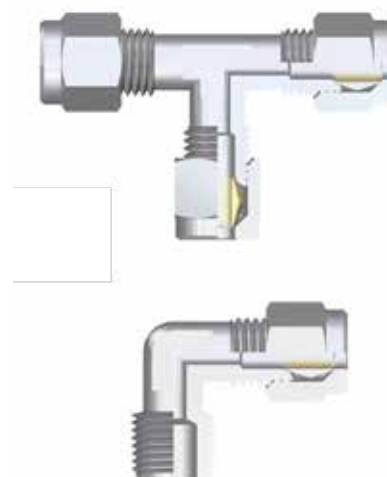

Materiali e Componenti	IT	Component Parts and Materials	GB	Komponenten und Materialien	DE
1 Dado in Ottone Nickelato		1 Nickel-plated Brass Nut		1 Überwurfmutter Messing vernickelt	
2 Ogiva in Ottone (PTFE a richiesta)		2 Brass Olive (If requested PTFE)		2 Klemmring Messing (PTFE auf Anfrage)	
3 Corpo in Ottone Nickelato		3 Nickel-plated Brass Body		3 Körper Messing vernickelt	
4 Bussolina di rinforzo		4 Internal support bush		4 Stützhülse Messing	
Matériaux et Composants	FR	Materiales y Componentes	ES	Materiais e Componentes	PT
1 Ecrou: laiton nickelé		1 Tuerca en Latón Niquelado		1 Porca em Latão niquelado	
2 Ague: laiton (sur demande en PTFE)		2 Bicono en Latón (PTFE a demanda)		2 Bucha em Latão (PTFE sob encomenda)	
3 Corps: laiton nickelé		3 Cuerpo en Latón Niquelado		3 Corpo em Latão niquelado	
4 Fourrure intérieure: laiton		4 Refuerzo		4 Bucha de reforço interna	



Tubi di Collegamento	IT	Connection Tubes	GB	Geeignete Rohre	DE
Tubi in rame, ferro, acciaio, alluminio, ottone, ecc. Con apposito rinforzo interno (art. 10770), possono essere utilizzati anche tubi in PA11, PA6, ecc.		Tubes made in copper, steel, iron, aluminium, brass, etc. With an inside support bush (art. 10770), can be used also for plastic material such as PA11, PA6, etc.		Rohre in Kupfer, Eisen, Stahl, Aluminium, Messing, usw. Mit einer internen Stützhülse (Art. 10770), können auch Rohre aus PA11, PA6, usw. verwendet werden.	
Tubes Conseillés	FR	Tubos de Conexión	ES	Tubos de Conexão	PT
Tubes en cuivre, acier, aluminium, laiton, etc. Avec une fourrure intérieure (art. 10770), les tubes plastiques PA11, PA6, etc. peuvent être utilisés.		Tubos en cobre, hierro, acero, aluminio, latón, etc. Con el correspondiente refuerzo interno (art. 10770), pueden utilizarse también con tubo en PA11, PA6, etc.		Tubos de cobre, ferro, aço, alumínio, latão, etc. Com bucha de reforço interna (cód. 10770), podem ser utilizados também com tubos em PA11, PA6, etc.	



Filettatura	IT	Threads	GB	Gewindearten	DE
Gas conica conforme ISO 7.1, BS 21, DIN 2999. Gas cilindrica conforme ISO 228 Classe A. Metrica conforme ISO R/262.		Tapered gas in conformity with ISO 7.1, BS 21, DIN 2999. Parallel gas in conformity with ISO 228 Class A. Metric in conformity with ISO R/262.		Konisches Gewinde nach Norm ISO 7.1, BS 21, DIN 2999. Zylindrisches Gewinde nach Norm ISO 228 Classe A. Metrisches Gewinde nach Norm ISO R/262.	
Filetages	FR	Roscas	ES	Roscas	PT
Filetage conique conforme: ISO 7.1, BS 21, DIN 2999. Filetage cylindrique conforme: ISO 228 Classe A. Filetage métrique conforme: ISO R/262.		Gas cónica conforme ISO 7.1, BS 21, DIN 2999. Gas cilíndrica conforme ISO 228 Clase A. Métrica conforme ISO R/262.		Gas cônica conforme ISO 7.1, BS 21, DIN 2999. Gas paralela conforme ISO 228 Classe A. Métrica conforme ISO R/262.	



Pressioni e Temperature

IT

Pressioni e temperature vengono determinate dal tipo di tubo impiegato, pertanto tali valori sono da definirsi in base alle caratteristiche del tubo stesso.

Riportiamo di seguito i valori delle pressioni massime consigliate per l'utilizzo dei raccordi con tubi di rame dallo spessore di 1 mm a 20° C.

I valori delle pressioni consigliate, riportate in tabella, sono stati ottenuti dai valori di prova adottando un Coefficiente di Sicurezza 4.

Sono disponibili i certificati delle prove rilasciati dai vari laboratori che le hanno eseguite.

Pressures and Temperatures

GB

The working pressures and working temperatures depend on which type of tube is used, for this reason, the values must be determined in accordance with the tube's features.

Hereunder, we specify the values of the maximum pressure advised for the fittings at a temperature of 20° C connected with copper tube, which has a thickness of 1 mm.

The values of working pressures advised, specified in table have been obtained from the test values using a Safety Factor 4.

It is available the test report made by the external laboratory test.

Druckbereich und Temperatur

DE

Drücke und Temperaturen sind definiert durch die verwendete Ausführung der Leitung, d.h. die Werte der eingesetzten Rohre sind zu beachten.

Nachfolgend geben wir die Werte des maximalen Druckes für den Einsatz der Verschraubungen mit Kupferrohren an, deren Wandstärke min. 1mm beträgt und bei einer Temperatur von 20° C.

Es muss berücksichtigt werden, dass die angegebenen Druckwerte in der Tabelle mit einem Sicherheitsfaktors von 4 berechnet wurden.

Es stehen Prüfberichte zur Verfügung, die von verschiedenen, externen Labors gemacht wurden.

Pressions et Températures

FR

Les pressions et températures de service dépendent du type de tube utilisé. Pour cette raison, les valeurs doivent être déterminées en conformité avec les caractéristiques du tube. Ci-dessous, nous indiquons les valeurs de la pression maximale recommandée pour une connexion avec un tube en cuivre de 1 mm d'épaisseur à une température de 20° C.

Les pressions de service indiquées ont été calculées avec un coefficient de sécurité de 4.

Des rapports externes de tests sont disponibles sur demande pour attester ces valeurs.

Presiones y Temperaturas

ES

Presión y temperatura vienen determinadas según el tipo de tubo empleado, por lo tanto estos valores se definen en base a las características del mismo tubo. Representamos a continuación los valores de las presiones máximas aconsejadas para la utilización de los racores con tubo de cobre espesor 1 mm a 20° C.

Los valores de las presiones aconsejadas, representadas en la tabla, han sido obtenidas de valores de prueba adoptando un coeficiente de seguridad 4.

Están disponibles los certificados de las pruebas realizadas en distintos laboratorios especializados.

Pressões e Temperaturas

PT

Pressões e temperaturas dependem do tipo de tubo aplicado, portanto tais valores devem ser definidos com base nas características do tubo em questão.

A seguir apresentamos os valores das pressões máximas aconselhadas para a utilização das conexões com tubos de cobre de espessura de 1 mm a 20° C.

Os valores das pressões aconselhadas, reportados na tabela, foram obtidas dos valores de teste adotando-se um Coeficiente de Segurança 4.

Os certificados de teste executados por laboratórios externos estão disponíveis.



Temperature

Temperatures

Temperatur

Températures

Temperaturas

Temperaturas

- 60 °C

+ 300 °C

Misura Size Größe Dimensions Tamaño Tamanho	Pressione massima consigliata a 20 °C Maximum pressure advised at 20 °C Maximal Empfohlener Druck bei 20 °C Pression maximum conseillée à 20 °C Presión máxima aconsejada a 20 °C Pressão máxima aconselhada a 20 °C
Ø	kg/cm ² bar
4	150 148.4
6	150 148.4
8	130 128.6
10	180 178.1
12	150 148.4
14	115 113.3
15	75 74.2
16	75 74.2
18	60 59.4
22	40 39.6



Fluidi compatibili

Acqua / Olio / Aria compressa

Fluidi in genere per l'impiantistica idraulica, oleodinamica, idropneumatica, ecc.

Fluids

Water / Oils / Compressed air

Fluids in general for the hydraulic, pneumatic and oildynamic plants etc.

Geeignete Medien

Wasser / Oel / Druckluft

Medien im Allgemeinen für hydraulische-, hydropneumatische- und pneumatische Anlagen, usw.

Fluides compatibles

Eau / Huile / Air comprimé

Fluides courants utilisés en hydraulique et pneumatique, etc.

Fluidos compatibles

Agua / Aceite / Aire comprimido

Fluidos en general para los campos hidráulicos, neumáticos y oleodinámicos, etc.

Fluidos compatíveis

Água / Óleo / Ar comprimido

Fluidos em geral para aplicações hidráulicas, oleodinâmicas, hidropneumáticas, etc.



Coppia di serraggio

Torque specifications

Angaben Drehmoment

Couple de serrage

Par de apriete

Especificações de Torque

COPPIE DI SERRAGGIO DADO SU OGIVA TORQUE FORCE ON OLIVE NUT ANZUGSDREHMOMENT ZWISCHEN MUTTER UND KLEMMRING COUPLE DE SERRAGE DE L'ÉCROU SUR LA BAGUE OLIVE PAR DE APRIETE DE LA TUERCA DE OJIVA TORQUE DE APERTO PARA PORCA EM BUCHA			
Ø	N° Giri chiave N° Key turns N° Schlüssel Umdrehungen N° de tours N° Giro de la tuerca N° Rotação da porca	N.m	Kgf.m
mm			
4	1 1/4 + 1/4	15	1.55
6	1 1/4 + 1/4	18	1.85
8	1 1/4 + 1/4	22	2.25
10	1 1/4 + 1/4	40	4
12	1 1/4 + 1/4	50	5
14	1 1/4 + 1/4	70	7.1
15	1 + 1/4	90	9.1
16	1 + 1/4	90	9.1
18	1 + 1/4	130	13.25
22	1 + 1/4	130	13.25

Forze di serraggio, minime consigliate, e n° di giri utili, per garantire un montaggio corretto.
Torque force, minimum recommended, and useful turn, to ensure a correct installation.
Empfohlenes Anzugsdrehmoment und mindest umdrehungsanzahl für eine korrekte montage.
Couple de serrage minimum recommandé et nombre de tours pour assurer une installation correcte.
Par de apriete mínimo recomendado y n. giros necesarios para garantizar un montaje correcto.
Torque de aperto mínimo garantido, n. rotações necessário para garantir a correcta instalação.

10200

RACCORDO A T INTERMEDIO

TEE CONNECTOR

T-ANSCHLUSS

RACCORD TÉ

RACOR A T INTERMEDIO

CONEXÃO EM "T" TUBO-TUBO

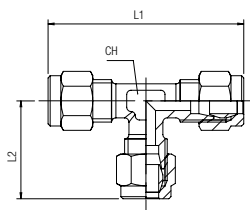

Code	Tube	L1	L2	CH	Pack.
10200 00 001	4	41	20.5	8	10
10200 00 002	6	46	23	9	10
10200 00 003	8	53	26.5	12	10
10200 00 004	10	62	31	13	10
10200 00 005	12	67	33.5	14	10
10200 00 006	14	72	36	18	10
10200 00 007	15	78	39	18	10
10200 00 008	16	78	39	17	10
10200 00 009	18	83	41.5	20	10
10200 00 010	22	86	43	27	10

Fino ad esaurimento scorte

Until the end stock

Nur solange vorrat

Livvable jusqu'à épauement du stock

Hasta fin de stock

Ate fim do stock

10220

RACCORDO A T MASCHIO CENTRALE

TEE MALE ADAPTOR CENTRE LEG

T-EINSCHRAUBVERSCHRAUBUNG KONISCH

TÉ À PIQUAGE MÂLE CENTRAL, CONIQUE

RACOR A T MACHO CENTRAL

CONEXÃO EM "T" COM ROSCA MACHO CENTRAL

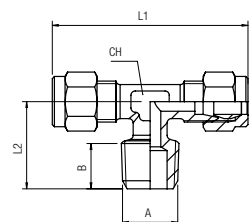

Code	Tube	A	L1	L2	CH	Pack.
10220 00 001	4	1/8	41	15	8	10
10220 00 002	6	1/8	46	16.5	9	10
10220 00 003	6	1/4	46	20.5	9	10
10220 00 004	8	1/8	53	16.5	12	10
10220 00 005	8	1/4	53	20.5	12	10
10220 00 006	8	3/8	57	23	13	10
10220 00 007	10	1/4	62	22.5	13	10
10220 00 008	10	3/8	62	23.5	13	10
10220 00 009	10	1/2	64	27	14	10
10220 00 010	12	1/4	66	24.5	14	10
10220 00 011	12	3/8	66	25	14	10
10220 00 012	12	1/2	67	26.5	14	10
10220 00 013	14	3/8	75	26	16	10
10220 00 014	14	1/2	78	31	18	10
10220 00 015	15	1/2	80	31	18	10
10220 00 016	16	1/2	79	28	17	10
10220 00 017	18	1/2	84	29.5	20	10
10220 00 018	18	3/4	82	32.5	20	10
10220 00 019	22	3/4	86	34	27	10

Fino ad esaurimento scorte

Until the end stock

Nur solange vorrat

Livvable jusqu'à épauement du stock

Hasta fin de stock

Ate fim do stock

10230

RACCORDO A T MASCHIO LATERALE

TEE MALE ADAPTOR OFF SET LEG

L-EINSCHRAUBVERSCHRAUBUNG KONISCH

TÉ À PIQUAGE LATÉRAL, CONIQUE

RACOR A T MACHO LATERAL

CONEXÃO EM "T" COM ROSCA MACHO LATERAL

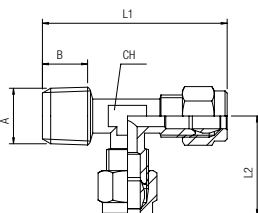

Code	Tube	A	L1	L2	CH	Pack.
10230 00 001	4	1/8	35	21	8	10
10230 00 002	6	1/8	39	24	9	10
10230 00 003	6	1/4	43	23	9	10
10230 00 004	8	1/8	43	26	12	10
10230 00 005	8	1/4	46	26	12	10
10230 00 006	8	3/8	49	26	13	10
10230 00 007	10	1/4	55	31	13	10
10230 00 008	10	3/8	54	31	13	10
10230 00 009	12	3/8	58	33	14	10
10230 00 010	12	1/2	59	34	15	10
10230 00 011	14	1/2	67	39	18	10

Fino ad esaurimento scorte

Until the end stock

Nur solange vorrat

Livvable jusqu'à épauement du stock

Hasta fin de stock

Ate fim do stock

10240

RACCORDO A T FEMMINA CENTRALE

TEE FEMALE CENTRE LEG
 T-EINSCHRAUBVERSCHRAUBUNG INNENGEWINDE
 TÉ FEMELLE CENTRAL
 RACOR A T HEMBRA CENTRAL
 CONEXÃO EM "T" COM ROSCA FÊMEA CENTRAL

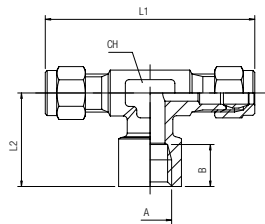

Code	Tube	A	B	L1	L2	CH	Pack.
10240 00 001	4	1/8	8.5	42	18	8	10
10240 00 002	6	1/8	8.5	46.5	19.5	9	10
10240 00 003	6	1/4	11	54	24.5	13	10
10240 00 004	8	1/8	8.5	53	19.5	12	10
10240 00 005	8	1/4	11	55	24.5	13	10
10240 00 007	10	1/4	11	63	24.5	13	10
10240 00 008	10	3/8	10.5	65	26	14	10
10240 00 009	10	1/2	10.5	66	26	15	10
10240 00 010	12	1/4	11	66	25.5	14	10
10240 00 011	12	3/8	10.5	66	26	14	10
10240 00 012	12	1/2	10.5	66	26	15	10
10240 00 013	14	1/2	10.5	67	30	18	10
10240 00 014	15	1/2	10.5	77	30	18	10
10240 00 015	16	1/2	10.5	77	28.5	17	10
10240 00 016	18	1/2	10.5	84	28	20	10
10240 00 017	18	3/4	14	83	34	20	10

Fino ad esaurimento scorte
 Until the end stock
 Nur solange vorrat
 Livrable jusqu'à épuisement du stock
 Hasta fin de stock
 Ate fim do stock

10260

RACCORDO A L INTERMEDIO

ELBOW CONNECTOR
 WINKELVERSCHRAUBUNG
 RACCORD EQUERRE
 RACOR A L INTERMEDIO
 CONEXÃO EM "L" TUBO-TUBO

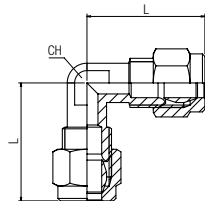

Code	Tube	L	CH	Pack.
10260 00 001	4	20	8	10
10260 00 002	6	24	9	10
10260 00 003	8	28	11	10
10260 00 004	10	32	13	10
10260 00 005	12	34	14	10
10260 00 006	14	36.5	17	10
10260 00 007	15	38	17	10
10260 00 008	16	39	17	10
10260 00 009	18	41.5	20	10
10260 00 010	22	43	27	10

Fino ad esaurimento scorte
 Until the end stock
 Nur solange vorrat
 Livrable jusqu'à épuisement du stock
 Hasta fin de stock
 Ate fim do stock

10280

RACCORDO A L MASCHIO

ELBOW MALE ADAPTOR
 WINKELVERSCHRAUBUNG KONISCH
 EQUERRE MÂLE, CONIQUE
 RACOR A L MACHO
 CONEXÃO EM "L" COM ROSCA MACHO

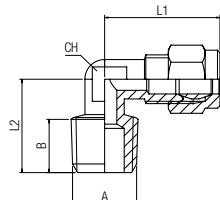

Code	Tube	A	L1	L2	CH	Pack.
10280 00 001	4	1/8	20.5	15	8	10
10280 00 002	6	1/8	23.5	17	9	10
10280 00 003	6	1/4	23.5	19	9	10
10280 00 004	8	1/8	28	18	11	10
10280 00 005	8	1/4	28	21.5	11	10
10280 00 006	8	3/8	28.5	24	13	10
10280 00 007	10	1/4	32	23.5	13	10
10280 00 008	10	3/8	32	24.5	13	10
10280 00 009	10	1/2	34	25	14	10
10280 00 010	12	1/4	34	24	14	10
10280 00 011	12	3/8	34	26	14	10
10280 00 012	12	1/2	34	25	14	10
10280 00 013	14	3/8	38	26	17	10
10280 00 014	14	1/2	38	28.5	17	10
10280 00 015	15	1/2	39	28.5	17	10
10280 00 016	16	1/2	40	28	17	10
10280 00 017	18	1/2	42	29.5	20	10
10280 00 018	18	3/4	42	32	20	10
10280 00 019	22	3/4	42.5	34	27	10

Fino ad esaurimento scorte
 Until the end stock
 Nur solange vorrat
 Livrable jusqu'à épuisement du stock
 Hasta fin de stock
 Ate fim do stock

10290

RACCORDO A L FEMMINA

ELBOW FEMALE ADAPTOR
 WINKELVERSCHRAUBUNG INNENGEWINDE
 EQUERRE FEMELLE
 RACOR A L HEMBRA
 CONEXÃO EM "L" COM ROSCA FÊMEA

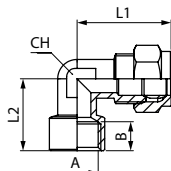

Code	Tube	A	B	L1	L2	CH	Pack.
10290 00 001	4	1/8	8.5	22	18	8	10
10290 00 002	6	1/8	8.5	23.5	18	9	10
10290 00 003	6	1/4	10.5	24	22.5	11	10
10290 00 004	8	1/8	8.5	28	21	11	10
10290 00 005	8	1/4	11	28.5	25.5	13	10
10290 00 006	8	3/8	10.5	29	25	14	10
10290 00 007	10	1/4	11	34	25	13	10
10290 00 008	10	3/8	10.5	33	25	14	10
10290 00 009	10	1/2	10.5	33	27	15	10
10290 00 010	12	1/4	11	34	26	14	10
10290 00 011	12	3/8	10.5	34	26	14	10
10290 00 012	12	1/2	10.5	33	27	15	10
10290 00 013	14	1/2	10.5	38.5	30	18	10
10290 00 014	15	1/2	10.5	39	30	18	10
10290 00 015	16	1/2	10.5	40	30	18	10
10290 00 016	18	1/2	10.5	42	29	20	10
10290 00 017	18	3/4	14	42	33.5	20	10

Fino ad esaurimento scorte
 Until the end stock
 Nur solange vorrat
 Livrable jusqu'à épauement du stock
 Hasta fin de stock
 Ate fim do stock

10460

RACCORDO DIRITTO INTERMEDIO

STRAIGHT CONNECTOR
 VERBINDUNGSVERSCHRAUBUNG
 RACCORD UNION DOUBLE
 RACOR RECTO INTERMEDIO
 CONEXÃO RETA TUBO-TUBO

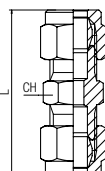

Code	Tube	L	CH	Pack.
10460 00 001	4	30.5	10	10
10460 00 002	6	35	11	10
10460 00 003	8	36	13	10
10460 00 004	10	43.5	16	10
10460 00 005	12	44	18	10
10460 00 006	14	47	21	10
10460 00 007	15	52	21	10
10460 00 008	16	52.5	22	10
10460 00 009	18	56.5	26	10
10460 00 010	22	55	30	10

Fino ad esaurimento scorte
 Until the end stock
 Nur solange vorrat
 Livrable jusqu'à épauement du stock
 Hasta fin de stock
 Ate fim do stock

10465

RACCORDO DRITTO INTERMEDIO DI ATTRAVERSAMENTO

STRAIGHT BULKHEAD CONNECTOR
 SCHOTTVERSCHRAUBUNG
 RACCORD DROIT TRAVERSÉE DE CLOISON
 RACOR RECTO INTERMEDIO PASATABIQUES
 CONEXÃO RETA PASSAMURO TUBO-TUBO

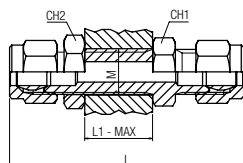

Code	Tube	L	L1 max	CH1	CH2	M	Pack.
10465 00 001	4	46.5	15	10	13	M8x1	10
10465 00 002	6	51.5	15	14	14	M10x1	10
10465 00 003	8	53	15	14	17	M12x1	10
10465 00 004	10	61.5	16	19	22	M16x1.5	10
10465 00 005	12	67.5	20	22	22	M18x1.5	10
10465 00 006	14	72	20	24	24	M20x1.5	10

Fino ad esaurimento scorte
 Until the end stock
 Nur solange vorrat
 Livrable jusqu'à épauement du stock
 Hasta fin de stock
 Ate fim do stock

10480

RACCORDO DIRITTO MASCHIO CONICO

STRAIGHT MALE ADAPTOR (TAPER)

GERADE EINSCHRAUBVERSCHRAUBUNG KONISCH

RACCORD DROIT MÂLE CONIQUE

RACOR RECTO MACHO

CONEXÃO RETA COM ROSCA MACHO

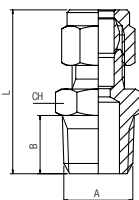

Code	Tube	A	L	CH	Pack.
10480 00 001	4	1/8	25.5	11	10
10480 00 002	4	1/4	28.5	14	10
10480 00 003	6	1/8	27.5	11	10
10480 00 004	6	1/4	31	14	10
10480 00 005	6	3/8	31.5	17	10
10480 00 006	8	1/8	28	13	10
10480 00 007	8	1/4	31.5	14	10
10480 00 008	8	3/8	32	17	10
10480 00 009	10	1/4	35	16	10
10480 00 010	10	3/8	35.5	17	10
10480 00 011	10	1/2	37	21	10
10480 00 012	12	1/4	36	18	10
10480 00 013	12	3/8	37	18	10
10480 00 014	12	1/2	37	21	10
10480 00 015	14	3/8	37	20	10
10480 00 016	14	1/2	39.5	21	10
10480 00 017	15	1/2	40	21	10
10480 00 018	16	1/2	42.5	22	10
10480 00 019	16	3/4	44	27	10
10480 00 020	18	1/2	44	24	10
10480 00 021	18	3/4	45.5	27	10
10480 00 022	22	1/2	44	30	10
10480 00 023	22	3/4	45.5	30	10

Fino ad esaurimento scorte

Until the end stock

Nur solange vorrat

Livrable jusqu'à épuisement du stock

Hasta fin de stock

Ate fim do stock

10485

RACCORDO DIRITTO MASCHIO CILINDRICO

STRAIGHT MALE ADAPTOR (PARALLEL)

GERADE EINSCHRAUBVERSCHRAUBUNG ZYLINDRISCH

RACCORD DROIT MÂLE CYLINDRIQUE

RACOR RECTO MACHO CILÍNDRICO

CONEXÃO RETA COM ROSCA MACHO PARALELA

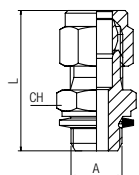

Code	Tube	A	L	CH	Pack.
10485 00 001	4	1/8	25	13	10
10485 00 002	6	1/8	26.5	13	10
10485 00 003	6	1/4	30	17	10
10485 00 004	8	1/8	28.5	13	10
10485 00 005	8	1/4	31	17	10
10485 00 006	8	3/8	34.5	22	10
10485 00 007	10	1/4	34.5	17	10
10485 00 008	10	3/8	38	22	10
10485 00 009	14	3/8	39.5	22	10
10485 00 010	14	1/2	42	27	10
10485 00 011	22	3/4	47	32	10
10485 00 012	22	1"	50	40	10

min

max



Temperature

- 20 °C

+ 80 °C

Fino ad esaurimento scorte

Until the end stock

Nur solange vorrat

Livrable jusqu'à épuisement du stock

Hasta fin de stock

Ate fim do stock

10500

RACCORDO DIRITTO FEMMINA

STRAIGHT FEMALE ADAPTOR
 AUFSCHRAUBVERSCHRAUBUNG
 RACCORD DROIT TARAUEE
 RACOR RECTO HEMBRA
 CONEXÃO RETA COM ROSCA FÊMEA

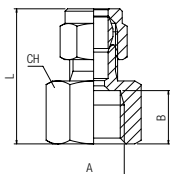

Code	Tube	A	B	L	CH	Pack.
10500 00 001	4	1/8	8.5	24	14	10
10500 00 002	4	1/4	11	26.5	17	10
10500 00 003	6	1/8	8.5	25.5	14	10
10500 00 004	6	1/4	11	28	17	10
10500 00 005	8	1/8	8.5	26	14	10
10500 00 006	8	1/4	11	28.5	17	10
10500 00 007	8	3/8	11.5	29.5	20	10
10500 00 008	10	1/4	11	32	17	10
10500 00 009	10	3/8	11.5	32.5	20	10
10500 00 010	10	1/2	13.5	34.5	24	10
10500 00 011	12	1/4	14.5	32	18	10
10500 00 012	12	3/8	11.5	32.5	20	10
10500 00 013	12	1/2	13.5	34.5	24	10
10500 00 014	14	3/8	11.5	34	20	10
10500 00 015	14	1/2	13.5	36.5	24	10
10500 00 016	15	1/2	13.5	36.5	24	10
10500 00 017	16	1/2	13.5	39	24	10
10500 00 018	16	3/4	14.5	40.5	30	10
10500 00 019	18	1/2	13.5	40	24	10
10500 00 020	18	3/4	14.5	41	30	10
10500 00 021	22	3/4	14.5	40	30	10

Fino ad esaurimento scorte

Until the end stock

Nur solange vorrat

Livable jusqu'à épauisement du stock

Hasta fin de stock

Ate fim do stock

10510

RACCORDO A CROCE

EQUAL CROSS
 KREUZVERSCHRAUBUNG
 RACCORD EN CROIX
 RACOR A CRUZ
 CONEXÃO TIPO CRUZETA TUBO-TUBO

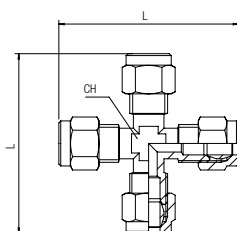

Code	Tube	L	CH	Pack.
10510 00 001	4	45	8	10
10510 00 002	6	47	9	10
10510 00 003	8	54	11	10
10510 00 004	10	64	13	10
10510 00 005	12	70	17	10
10510 00 006	14	74.5	17	10

Fino ad esaurimento scorte

Until the end stock

Nur solange vorrat

Livable jusqu'à épauisement du stock

Hasta fin de stock

Ate fim do stock

10550

RACCORDO ORIENTABILE A L CON VITE

SINGLE BANJO BODY WITH STEM

WINKELSCHWENKVERSCHRAUBUNG (DREHBAR)

EQUERRE MÂLE BANJO, ORIENTABLE

RACOR ORIENTABLE A L CON TORNILLO

CONEXÃO EM "L" ORIENTÁVEL TIPO BANJO

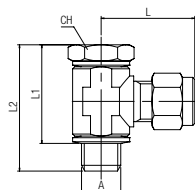

Code	Tube	A	L	L2	L1	CH	Pack.
10550 00 001	4	1/8	21.5	31	23	14	10
10550 00 002	6	1/8	23	31	23	14	10
10550 00 003	6	1/4	26	32	23.5	17	10
10550 00 004	8	1/8	26.5	31	23	14	10
10550 00 005	8	1/4	27	32	23.5	17	10
10550 00 006	8	3/8	28	36	26.5	19	10
10550 00 007	10	1/4	31.5	32	23.5	17	10
10550 00 008	10	3/8	32.5	36	26.5	19	10
10550 00 009	14	1/4	36.5	44	36.5	17	10
10550 00 010	14	3/8	36.5	46	37	22	10
10550 00 011	14	1/2	36.5	49	38	24	10
10550 00 012	22	3/4	45.5	64	52	32	10

min max



Temperature

- 20 °C

+ 80 °C

Fino ad esaurimento scorte

Until the end stock

Nur solange vorrat

Livable jusqu'à épuisement du stock

Hasta fin de stock

Ate fim do stock

10680

DADO

NUT

ÜBERWURFMUTTER

ECROU

TUERCA

PORCA

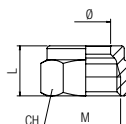

Code	Tube	L	CH	M	Pack.
10680 00 01 X1 NB	4	9.5	10	M 8x1	50
10680 00 01 X4 NB	6	10.5	12	M 10x1	50
10680 00 01 X7 NB	8	11.5	14	M 12x1	50
10680 00 01 X9 NB	10	13.5	19	M 16x1.5	50
10680 00 01 Y1 NB	12	13.5	21	M 18x1.5	50
10680 00 01 Y3 NB	14	14.5	23	M 20x1.5	20
10680 00 01 Y4 NB	15	16	23	M 20x1.5	20
10680 00 01 Y5 NB	16	17	25	M 22x1.5	20
10680 00 01 Y7 NB	18	18	28	M 24x1.5	20
10680 00 01 J1 NB	22	18	34	M 30x1.5	10

Fino ad esaurimento scorte

Until the end stock

Nur solange vorrat

Livable jusqu'à épuisement du stock

Hasta fin de stock

Ate fim do stock

10760

OGIVA PTFE

PTFE OLIVE

KLEMMRING PTFE

OLIVE PTFE

BICONO PTFE

BUCHA EM PTFE

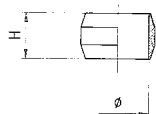

Code	Tube	H	Pack.
10760 00 28 X1 00	4	5.5	50
10760 00 28 X4 00	6	6.5	50
10760 00 28 X7 00	8	6.5	50
10760 00 28 X9 00	10	7.5	50
10760 00 28 Y1 00	12	8	50
10760 00 28 Y3 00	14	8.5	50
10760 00 28 Y4 00	15	9	50
10760 00 28 Y5 00	16	9.5	50
10760 00 28 Y7 00	18	10	50
10760 00 28 J1 00	22	10	50

Fino ad esaurimento scorte

Until the end stock

Nur solange vorrat

Livable jusqu'à épuisement du stock

Hasta fin de stock

Ate fim do stock