

**RACCORDI A COMPRESSIONE IN ACCIAIO INOX AISI 316L**

*STAINLESS STEEL AISI 316L COMPRESSION FITTINGS*

*KLEMMRINGVERSCHRAUBUNGEN AUS EDELSTAHL AISI 316L*

*RACCORDS À BAGUES BICÔNE EN ACIER INOX AISI 316L*

*RACORDAJE A COMPRESIÓN EN ACERO INOX AISI 316L*

*CONEXÕES DE COMPRESSÃO EM AÇO INOXIDÁVEL AISI 316L*



**Serie 69000**

Raccordi a compressione in acciaio AISI 316L (1.4404).

Le possibilità di utilizzo e di connessione sono molteplici, si possono connettere in assoluta sicurezza tubi rigidi metallici (acciaio, ottone, rame, alluminio) e tubi in materiali termo plastici come poliuretano, poliammide e teflon.

### Principali vantaggi

- Gamma completa
- Per tutti i fluidi e gli ambienti corrosivi
- Completamente in AISI 316L
- Robustezza meccanica
- Tenuta garantita su differenti tipologie di tubi
- Senza elementi di tenuta (elastomeri)
- Dal Ø 4 mm al Ø 12 mm

### Applicazioni

- Industria Agroalimentare
- Industria Chimica, Petrochimica e Farmaceutica
- Medica, Life&Sciences
- Inkjet, Inchiostri
- Automazione Pneumatica e Fluidica
- Food & Beverage
- Gas Inerti
- Automazione Pneumatica pesante e strumenti
- Automotive

Raccords à compression en acier AISI 316L (1.4404).

Les possibilités d'utilisation et de connexion sont multiples, vous pouvez connecter en toute sécurité tubes rigides métalliques (acier, laiton, cuivre, aluminium) et des tubes en matériaux thermoplastiques tels que le polyéthylène, polyamide et téflon.

### Principaux avantages

- Gamme complète
- Pour tous fluides et environnements corrosifs
- Complètement en AISI 316L
- Robustesse mécanique
- Étanchéité garantie sur différents types de tubes
- Sans éléments d'étanchéité (élastomères)
- De Ø 4 mm à Ø 12 mm

### Application

- Industrie agroalimentaire
- Industries chimiques, pétrochimiques et pharmaceutiques
- Médical
- Imprimerie
- Automatisation pneumatique et fluidique
- Alimentaire et boissons
- Gaz inerte
- Automatisation pneumatique lourde
- Automobile

Stainless steel AISI 316L compression fittings (1.4404).

Perfect solution for multiple application and connection, it's possible to connect with several rigid metallic tube in complete safety (stainless steel, brass, aluminum, copper) but also plastic made tubes like polyurethane, polyamide, Teflon.

### Main advantages

- Complete range
- For all corrosive fluids and environment
- Completely made in AISI 316L
- Mechanical strength
- Sealing is guaranteed on different type of tube
- No sealing elements (elastomeric)
- From Ø 4 mm to Ø 12 mm

### Applications

- Food farming industry
- Chemical, Petrochemical, Pharmaceutical industries
- Medical and Life & Science
- Inkjet, Printing
- Pneumatic and Fluid Automation
- Food & Beverages
- Inert gases
- Heavy duty Pneumatic Automation & tools
- Automotive

Las posibilidades de utilización y de conexión son múltiples, pueden conectarse con absoluta seguridad tubos rígidos metálico (latón, cobre, aluminio) y tubos en material plástico como poliuretano, poliamida y teflón. Disponibles anillos en teflón.

### Principales ventajas

- Gama completa
- Para todos los fluidos y ambientes corrosivos
- Completamente en Acero Inox 316L
- Robustez mecánica
- Estanqueidad garantizada con diferentes tipologías
- Sin elementos de estanqueidad (Elastomeros)
- Del Ø 4 mm al Ø 12 mm

### Aplicaciones

- Industria agroalimentaria
- Industria Química, petroquímica y farmacéutica
- Medical, Life&Sciences
- Inyección de tinta, impresión
- Pneumáticas et autres fluides industriels
- Alimentos y bebidas
- Gases inertes
- Automatización neumática pesada
- Automoción

Edelstahl AISI 316L Klemmring verschraubungen (1.4404).

Speziell entwickelt für die sichere Verbindung von Metall-Rohren (Messing, Kupfer, Aluminium) bei geringem bis mittlerem Druck. Verbindung mit PU, PA und PTFE-Schläuchen mit einer Stützhülse.

### Hauptvorteile

- Grosses Sortiment
- Alle Medien in aggressiver Umgebung
- Komplett aus Edelstahl AISI 316L
- Mechanische Festigkeit
- Sichere Verbindung mit allen Rohren
- Metall-Dichtungen
- Von Ø 4 mm bis Ø 12 mm

### Anwendungen

- Landwirtschaft, Bergbau
- Chemie, Petrochemie, Pharma
- Medizin, Life Sciences
- Inkjet, Druck
- Pneumatik und Fluidtechnik
- Lebensmittel & Getränke
- Inertgase
- Schwere pneumatische Automation
- Automobil-Industrie

Especialmente desenvolvido para conectar tubos metálicos (latão, cobre, alumínio) e assegurar conexões em pressões médias e baixas.

Conexão com tubos em PU, PA e PTFE através de uma bucha interna.

### Principais vantagens

- Grande range de itens
- Todos os fluidos em ambientes agressivos
- Totalmente fabricada em aço-inoxidável AISI 316L
- Resistência Mecânica
- Conexão segura com diferentes tubos
- Vedação metálica
- Para tubos de Ø 4 mm a Ø 12 mm

### Aplicações

- Fazendas, Mineração
- Química, Petroquímica, Farmacêutica
- Médica, Life&Sciences
- Impressora, Jatos de tinta
- Pneumáticas et autres fluides industriels
- Alimentícia e bebidas
- Gases Inertes
- Automação Pneumática Pesada
- Automotiva



## Montaggio

IT

Per garantire le migliori prestazioni dei nostri raccordi, riportiamo una sequenza di operazioni da eseguire durante il montaggio, che contribuiranno ad eliminare sprechi di tempo e cattive applicazioni del prodotto.

## Assembling

GB

To ensure the best function of our fittings, please follow the under mentioned instructions, in order to avoid waste of time and bad applications of the product.

## Montageanleitung

DE

Um eine optimale Leistung unserer Armaturen zu gewährleisten haben wir in den folgenden Schritten die Montage der Verbindung dokumentiert. Damit sollte keine falsche Montage durchgeführt und keine verschwendete Zeit benötigt werden.

## Assemblage

FR

Pour assurer le bon fonctionnement des raccords, veuillez suivre les instructions de montage ci-dessous afin d'éviter le gaspillage de temps et une mauvaise utilisation des produits.

## Montaje

ES

Para garantizar las mejores prestaciones de nuestros racores, indicamos una secuencia de operaciones para seguir durante el montaje, que contribuirán a eliminar pérdidas de tiempo, e incorrectas aplicaciones del producto.

## Montagem

PT

Para garantir o melhor funcionamento das nossas conexões, mostramos a seguir uma sequência de operações a serem executadas durante a montagem, de forma a evitar desperdícios de tempo e má aplicação do produto.

1

Tagliare il tubo a 90° togliendo le bave interne ed esterne.

Cut the tube at 90° and remove internal and external burrs.

Schneiden Sie das Rohr 90° und entgraten Innen- und Aussen- kanten.

Couper le tube à 90° et l'ébavurer.

Cortar el tubo a 90° eliminando rebabas internas y externas.

Cortar o tubo a 90° e remover a as rebarbas internas e externas.

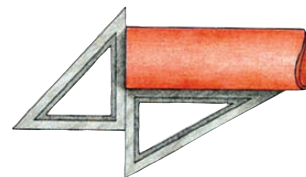

2

Avvitare manualmente il dado fino ad ottenere una certa resistenza dell'ogiva.

Screw the nut onto the fitting by hand until hand-tight.

Schrauben Sie die Überwurfmutter von Hand soweit an, bis Sie einen Widerstand bemerken.

Visser manuellement l'écrou jusqu'à obtenir une certaine résistance.

Apretar manualmente la tuerca hasta obtener cierta resistencia del bicono.

Apertar manualmente a porca sentir resistència da bucha.

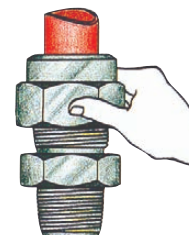

3

Verificare la completa adesione del tubo al corpo, forzando il medesimo verso l'interno del raccordo e quindi, con la chiave, bloccare il tubo.

Ensure the tube is pushed fully home into the fitting before tightening the nut with the correct spanner.

Bevor Sie die Überwurfmutter mit dem Schlüssel anziehen stellen Sie sicher, dass das Rohr ganz an den Anschlag in die Verschraubung geschoben ist.

Avant de serrer l'écrou avec la clé, vérifiez que le tube est en butée dans le corps du raccord.

Verificar la completa adhesión del tubo al cuerpo, forzándolo hacia el interno del racor y seguidamente con la llave, bloquear el tubo.

Garantir que o tubo esteja bem encaixado dentro da conexão antes de apertar a porca com a chave adequada. Se necessário, antes de apertar, empurre o tubo um pouco mais.

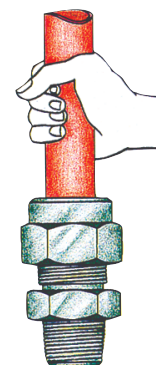

4

Stringere il dado (come indicato da tabella) ponendo, se necessario, dei punti di riferimento.

Tighten the nut with the spanner (see the chart), marking reference points, if necessary.

Ziehen Sie die Mutter mit dem Schlüssel (siehe tabelle) Umgang an, wenn nötig machen Sie Bezugspunkte.

Visser l'écrou en le tournant avec une clé (voir tableau). Si nécessaire, faire un repère de serrage.

Apretar la tuerca (ver tabla) indicando si es necesario un punto de referencia.

Aperte a porca (ver tabela). Se necessário use marcar de referência.

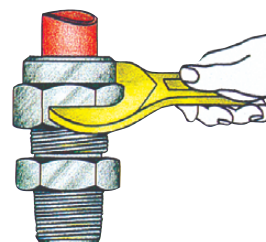

**SERIE 69000**

**RACCORDI A COMPRESIONE IN ACCIAIO INOX AISI 316L**  
**STAINLESS STEEL AISI 316L COMPRESSION FITTINGS**  
**KLEMMRINGVERSCHRAUBUNGEN AUS EDELSTAHL AISI 316L**  
**RACCORDS À BAGUES BICÔNE EN ACIER INOX AISI 316L**  
**RACORDAJE A COMPRESIÓN EN ACERO INOX AISI 316L**  
**CONEXÕES DE COMPRESSÃO EM AÇO INOXIDÁVEL AISI 316L**



**CARATTERISTICHE TECNICHE**  
**TECHNICAL CHARACTERISTICS**  
**TECHNISCHE ANGABEN**  
**CARACTÉRISTIQUES TECHNIQUES**  
**CARACTERÍSTICAS TÉCNICAS**  
**CARACTERÍSTICAS TÉCNICAS**



**Norma di Riferimento**  
**Reference standard**  
**Entspricht der Norm**  
**Norme de référence**  
**Normativa de referencia**  
**Norma de referência**

1907/2006 <b>REACH</b> ✓	2011/65/CE <b>RoHS</b> ✓
NSF/ANSI 169 <b>NSF</b>	PED 2014/68/UE
<b>SILICON FREE</b>	M.O.C.A. 1935/2004 CE

**Trattamento anti grippaggio.**  
 Anti-seize treatment.  
 Anti-seize behandlung.  
 Traitement antigrippant.  
 Tratamiento anti-gripante.  
 Tratamento anti-gripagem.

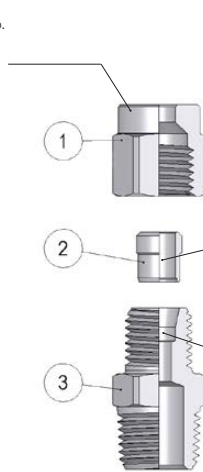

**Ogiva a norma DIN 3861 - EN ISO 8434.**  
 Olive in conformity with DIN Standard 3861 and EN ISO Standard 8434.  
 Ein Registriert unter DIN 3861 und EN ISO 8434 Klemmring.  
 Un enregistré en application DIN 3861 et EN ISO 8434 bicone.  
 Bicono a norma DIN 3861 y EN ISO 8434.  
 Bucha conforme com norma DIN 3861 e EN ISO 8434.

**Sede a norma ISO 8434.**  
 Seat in conformity with ISO Standards 8434.  
 Klemmring sitz unter ISO 8434.  
 Siège selon ISO 8434.  
 Sede segun ISO 8434.  
 Encaixe conforme com norma ISO 8434.

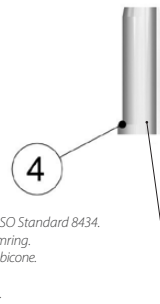

**Rinforzo Art. 69770.**  
 Internal support bush Art. 69770.  
 Verstärkung Art. 69770.  
 Renforcement Art. 69770.  
 Refuerzo Art. 69770.  
 Bucha de reforço interno Cód. 69770.

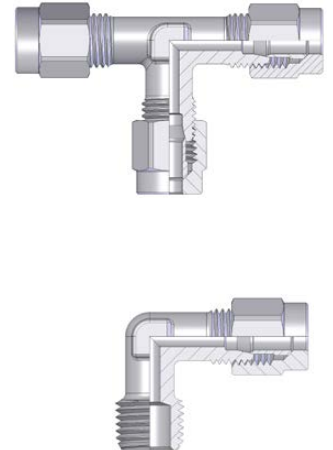

Materiali e Componenti	IT	Component Parts and Materials	GB	Komponenten und Materialien	DE
1 Dado in Acciaio Inox AISI 316L (1.4404)		1 Stainless Steel AISI 316L (1.4404) Nut		1 Überwurfmutter Edelstahl AISI 316L (1.4404)	
2 Ogiva in Acciaio Inox AISI 316L (1.4404)		2 Stainless Steel AISI 316L (1.4404) Olive		2 Klemmring Edelstahl AISI 316L (1.4404)	
3 Corpo in Acciaio Inox AISI 316L (1.4404)		3 Stainless Steel AISI 316L (1.4404) Body		3 Körper Edelstahl AISI 316L (1.4404)	
4 Rinforzo in Acciaio Inox AISI 304L (EN 1.4301)		4 Stainless Steel AISI 304L (EN 1.4301) Internal support		4 Stützhülse Edelstahl AISI 304L (EN 1.4301)	
Matériaux et Composants	FR	Materiales y Componentes	ES	Materiais e Componentes	PT
1 Ecrou: Acier Inoxydable AISI 316L (1.4404)		1 Tuerca en Acero Inoxidable AISI 316L (1.4404)		1 Porca em Aço Inoxidável AISI 316L (1.4404)	
2 Bague bicône: Acier Inoxydable AISI 316L (1.4404)		2 Bicono en Acero Inoxidable AISI 316L (1.4404)		2 Bucha em Aço Inoxidável AISI 316L (1.4404)	
3 Corps: Acier Inoxydable AISI 316L (1.4404)		3 Cuerpo en Acero Inoxidable AISI 316L (1.4404)		3 Corpo em Aço Inoxidável AISI 316L (1.4404)	
4 Fourrure intérieure: Acier Inoxydable AISI 304L (EN 1.4301)		4 Refuerzo en Acero Inoxidable AISI 304L (EN 1.4301)		4 Reforço interna em Aço Inoxidável AISI 304L (EN1.4301)	



Tubi di Collegamento	IT	Connection Tubes	GB	Geeignete Rohre	DE
Tubi in inox, rame, ferro, acciaio, alluminio, ottone. Con apposito rinforzo interno (art. 69770), possono essere utilizzati anche tubi in PA, FEP, PTFE, ecc.		Tubes in Stainless Steel, copper, steel, iron, aluminium, brass. With an inside support bush (art. 69770), can be used also for plastic material such as PA, FEP, PTFE, etc.		Rohre in Edelstahl, Kupfer, Eisen, Stahl, Aluminium, Messing. Mit einer internen Stützhülse (Art. 69770), können auch Rohre aus PA, FEP, PTFE, etc. verwendet werden.	
Tubes Conseillés	FR	Tubos de Conexión	ES	Tubos de Conexão	PT
Tubes en Acier Inoxydable, cuivre, acier, aluminium, laiton. Avec une fourrure intérieure (art. 69770), les tubes plastiques PA, FEP, PTFE, etc. peuvent être utilisés.		Tubos en Acero Inoxidable, cobre, hierro, acero, aluminio. Con el correspondiente refuerzo interno (art. 69770), pueden utilizarse también con tubo en PA, FEP, PTFE, etc.		Tubos de Aço Inoxidável, cobre, ferro, aço, alumínio, latão. Com bucha de reforço interna (cód. 69770), podem ser utilizados também com tubos em PA, FEP, PTFE, etc.	



<b>Filettatura</b>	<b>IT</b>	<b>Threads</b>	<b>GB</b>	<b>Gewindearten t</b>	<b>DE</b>
Gas conica conforme ISO 7.1, BS 21, DIN 2999. Gas cilindrica conforme ISO 7.1, BS 21, DIN 2999. Metrica conforme ISO 262.		Tapered gas in conformity with ISO 7.1, BS 21, DIN 2999. Parallel gas in conformity with ISO 228 Class A. Metric in conformity with ISO 262.		Konisches Gewinde nach Norm ISO 7.1, BS 21, DIN 2999. Zylindrisches Gewinde nach Norm ISO 228 Classe A. Metrisches Gewinde nach Norm ISO 262.	
<b>Filetages</b>	<b>FR</b>	<b>Roscas</b>	<b>ES</b>	<b>Roscas</b>	<b>PT</b>
Filetage conique conforme: ISO 7.1, BS 21, DIN 2999. Filetage cylindrique conforme: ISO 228 Class A. Filetage métrique conforme: ISO 262.		Gas cónica conforme ISO 7.1, BS 21, DIN 2999. Gas cilíndrica conforme ISO 228 Clase A. Métrica conforme ISO 262.		Gas cónica conforme ISO 7.1, BS 21, DIN 2999. Gas paralela conforme ISO 228 Classe A. Métrica conforme ISO 262.	



<b>Pressioni e Temperature</b>	<b>IT</b>	<b>Pressures and Temperatures</b>	<b>GB</b>	<b>Druckbereich und Temperatur</b>	<b>DE</b>
Pressioni e temperature vengono determinate dal tipo di tubo impiegato, pertanto tali valori sono da definirsi in base alle caratteristiche del tubo stesso. Riportiamo di seguito i valori delle pressioni massime consigliate per l'utilizzo dei raccordi con tubi inox dallo spessore di 1 mm a 20° C. I valori delle pressioni consigliate, riportate in tabella, sono stati ottenuti dai valori di prova adottando un Coefficiente di Sicurezza 4.		The working pressures and working temperatures depend on which type of tube is used, for this reason, the values must be determined in accordance with the tube's features. Hereunder, we specify the values of the maximum pressure advised for the fittings at a temperature of 20° C connected with copper tube, which has a thickness of 1 mm. The values of working pressures advised, specified in table have been obtained from the test values using a Safety Factor 4.		Drücke und Temperaturen sind definiert durch die verwendete Ausführung der Leitung, d.h. die Werte der eingesetzten Rohre sind zu beachten. Nachfolgend geben wir die Werte des maximalen Druckes für den Einsatz der Verschraubungen mit Kupferrohren an, deren Wandstärke min. 1mm beträgt und bei einer Temperatur von 20° C. Es muss berücksichtigt werden, dass die angegebenen Druckwerte in der Tabelle mit einem Sicherheitsfaktors von 4 berechnet wurden.	
<b>Pressions et Températures</b>	<b>FR</b>	<b>Presiones y Temperaturas</b>	<b>ES</b>	<b>Pressões e Temperaturas</b>	<b>PT</b>
Les pressions et températures de service dépendent du type de tube utilisé. Pour cette raison, les valeurs doivent être déterminées en conformité avec les caractéristiques du tube. Ci-dessous, nous indiquons les valeurs de la pression maximale recommandée pour une connexion avec un tube en cuivre de 1 mm d'épaisseur à une température de 20° C. Les pressions de service indiquées ont été calculées avec un coefficient de sécurité de 4.		Presión y temperatura vienen determinadas según el tipo de tubo empleado, por lo tanto estos valores se definen en base a las características del mismo tubo. Representamos a continuación los valores de las presiones máximas aconsejadas para la utilización de los racores con tubo de cobre espesor 1 mm a 20° C. Los valores de las presiones aconsejadas, representadas en la tabla, han sido obtenidas de valores de prueba adoptando un coeficiente de seguridad 4.		Pressões e temperaturas dependem do tipo de tubo aplicado, portanto tais valores devem ser definidos com base nas características do tubo em questão. A seguir apresentamos os valores das pressões máximas aconselhadas para a utilização das conexões com tubos de cobre de espessura de 1 mm a 20° C. Os valores das pressões aconselhadas, reportados na tabela, foram obtidas dos valores de teste adotando-se um Coeficiente de Segurança 4.	

**Temperature**

Temperatures

Temperatur

Températures

Temperaturas

Temperaturas

- 60 °C

+ 300 °C

**Pressioni**

Pressures

Druckbereich

Pressions

Presiones

Pressões

-0.99 bar (-0.099 MPa)

Ø 4/6/8: 200 bar (20 MPa)

Ø 10/12: 100 bar (10 MPa)

**Fluidi compatibili**

Fluidi per Industria alimentare e chimica compatibili con i componenti del raccordo.

**Fluids**

Fluid for food and chemical industry compatible with fitting components.

**Geeignete Medien**

Medien für die Lebensmittel- und chemische Industrie, die beständig mit den Komponenten der Verschraubungen sind.

**Fluides compatibles**

Fluides alimentaires et chimiques compatibles avec les matériaux constituant les raccords.

**Fluidos compatibles**

Fluidos para industria alimentaria y química compatibles con los componentes del racor.

**Fluidos compatíveis**

Fluidos para Indústria alimentícia e química compatíveis com os componentes da conexão.



**COPPIE DI SERRAGGIO DADO SU OGIVA**  
TORQUE FORCE ON OLIVE NUT  
ANZUGSDREHMOMENT ZWISCHEN MUTTER UND KLEMMRING  
COUPLE DE SERRAGE DE L'ÉCROU SUR LA BAGUE OLIVE  
PAR DE APRIETE DE LA TUERCA DE OJIVA  
TORQUE DE APERTO PARA PORCA EM BUCHA

Ø	N.m	Kgf.m
mm		
4	5	0.51
6	15	1.53
8	25	2.55
10	45	4.59
12	60	6.12

Forze di serraggio, minime consigliate, e n° di giri utili, per garantire un montaggio corretto.  
Torque force, minimum recommended, and useful turn, to ensure a correct installation.  
Empfohlenes anzugsdrehmoment und mindest umdrehungszahl für eine korrekte montage.  
Couple de serrage minimum recommandé et nombre de tours pour assurer une installation correcte.  
Par de apriete mínimo recomendado y n. giros necesarios para garantizar un montaje correcto.  
Torque de aperto mínimo garantido, n. rotação necessário para garantir a correcta instalação.

**69200**

**RACCORDO A T INTERMEDIO**

TEE CONNECTOR  
T-ANSCHLUSS  
RACCORD TÉ  
RACOR A T INTERMEDIO  
CONEXÃO EM "T" TUBO-TUBO

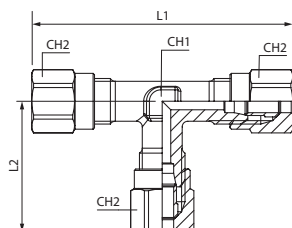

Code	Tube	L1	L2	CH1	CH2	Pack.
69200 00 001	4	46	23	9	10	2
69200 00 002	6	46	23	9	12	2
69200 00 003	8	51	25.5	12	14	2
69200 00 004	10	66	33	14	19	2
69200 00 005	12	70	35	17	22	2

Fino ad esaurimento scorte  
Until the end stock  
Nur solange vorrat  
Livrabte jusqu'à épuisement du stock  
Hasta fin de stock  
Ate fim do stock

**69200X**

**RACCORDO A T INTERMEDIO**

TEE CONNECTOR  
T-ANSCHLUSS  
RACCORD TÉ  
RACOR A T INTERMEDIO  
CONEXÃO EM "T" TUBO-TUBO

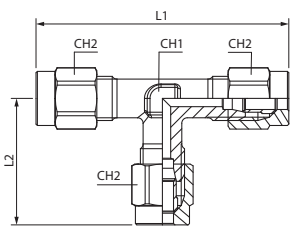

Code	Tube	L1	L2	CH1	CH2	Pack.
69200 X0 001	4	46	23	9	10	2
69200 X0 002	6	46	23	9	12	2
69200 X0 003	8	51	25.5	12	14	2
69200 X0 004	10	66	33	14	19	2
69200 X0 005	12	70	35	17	22	2

Dado a basso attrito per una chiusura semplificata  
Low friction nut for easier tightening  
Mutter mit geringer Reibung für leichtere Montage  
Ecrou a faible friction pour un serrage plus facile  
Tuerca de baja fricción para simplificar el apriete  
Porca de baixo atrito para um fechamento simplificado

**69220**

**RACCORDO A T MASCHIO CENTRALE**

TEE MALE ADAPTOR - CENTRE LEG  
T-EINSCHRAUBVERSCHRAUBUNG KONISCH  
TÉ À PIQUAGE MÂLE CENTRAL, CONIQUE  
RACOR A T MACHO CENTRAL  
CONEXÃO EM "T" COM ROSCA MACHO CENTRAL

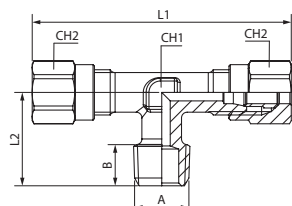

Code	Tube	A	B	L1	L2	CH1	CH2	Pack.
69220 00 001	4	1/8	7.5	46	16.5	9	10	2
69220 00 002	6	1/8	7.5	46	16.5	9	12	2
69220 00 004	8	1/8	7.5	51	17	12	14	2
69220 00 005	8	1/4	11	51	21	12	14	2
69220 00 006	8	3/8	11.5	51	22	12	14	2
69220 00 007	10	1/4	11	66	24.5	14	19	2
69220 00 008	10	3/8	11.5	66	25.5	14	19	2
69220 00 009	12	3/8	11.5	70	27	17	22	2
69220 00 010	12	1/2	14	70	31	17	22	2

Fino ad esaurimento scorte  
Until the end stock  
Nur solange vorrat  
Livrabte jusqu'à épuisement du stock  
Hasta fin de stock  
Ate fim do stock

**69220X**

**RACCORDO A T MASCHIO CENTRALE**

TEE MALE ADAPTOR - CENTRE LEG  
 T-EINSCHRAUBVERSCHRAUBUNG KONISCH  
 TÉ À PIQUAGE MÂLE CENTRAL, CONIQUE  
 RACOR A T MACHO CENTRAL  
 CONEXÃO EM "T" COM ROSCA MACHO CENTRAL

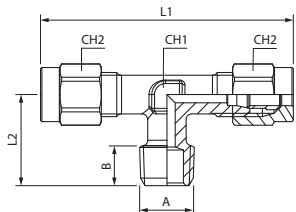

Code	Tube	A	B	L1	L2	CH1	CH2	Pack.
69220 X0 001	4	1/8	7.5	46	16.5	9	10	2
69220 X0 002	6	1/8	7.5	46	16.5	9	12	2
69220 X0 003	6	1/4	11	46	19.5	9	12	2
69220 X0 004	8	1/8	7.5	51	17	12	14	2
69220 X0 005	8	1/4	11	51	21	12	14	2
69220 X0 006	8	3/8	11.5	51	22	12	14	2
69220 X0 007	10	1/4	11	66	24.5	14	19	2
69220 X0 008	10	3/8	11.5	66	25.5	14	19	2
69220 X0 009	12	3/8	11.5	70	27	17	22	2
69220 X0 010	12	1/2	14	70	31	17	22	2

Dado a basso attrito per una chiusura semplificata  
 Low friction nut for easier tightening  
 Mutter mit geringer Reibung für leichtere Montage  
 Ecrou a faible friction pour un serrage plus facile  
 Tuerca de baja fricción para simplificar el apriete  
 Porca de baixo atrito para um fechamento simplificado

**69260**

**RACCORDO A L INTERMEDIO**

ELBOW CONNECTOR  
 WINKELVERSCHRAUBUNG  
 RACCORD EQUERRE  
 RACOR A L INTERMEDIO  
 CONEXÃO EM "L" TUBO-TUBO

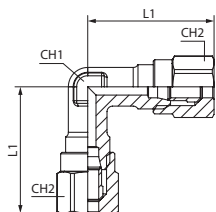

Code	Tube	L1	CH1	CH2	Pack.
69260 00 001	4	23	9	10	2
69260 00 002	6	23	9	12	2
69260 00 003	8	25.5	12	14	2
69260 00 004	10	33	14	19	2
69260 00 005	12	35	17	22	2

Fino ad esaurimento scorte  
 Until the end stock  
 Nur solange vorrat  
 Livrable jusqu'à épuisement du stock  
 Hasta fin de stock  
 Até fim do stock

**69260X**

**RACCORDO A L INTERMEDIO**

ELBOW CONNECTOR  
 WINKELVERSCHRAUBUNG  
 RACCORD EQUERRE  
 RACOR A L INTERMEDIO  
 CONEXÃO EM "L" TUBO-TUBO

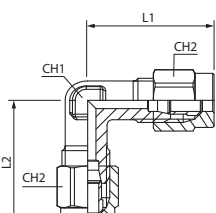

Code	Tube	L1	CH1	CH2	Pack.
69260 X0 001	4	23	9	10	2
69260 X0 002	6	23	9	12	2
69260 X0 003	8	25.5	12	14	2
69260 X0 004	10	33	14	19	2
69260 X0 005	12	35	17	22	2

Dado a basso attrito per una chiusura semplificata  
 Low friction nut for easier tightening  
 Mutter mit geringer Reibung für leichtere Montage  
 Ecrou a faible friction pour un serrage plus facile  
 Tuerca de baja fricción para simplificar el apriete  
 Porca de baixo atrito para um fechamento simplificado

## 69280

### RACCORDO A L MASCHIO

ELBOW MALE ADAPTOR  
WINKELVERSCHRAUBUNG  
EQUERRE MÂLE CONIQUE  
RACOR A L MACHO  
CONEXÃO EM "L" COM ROSCA MACHO

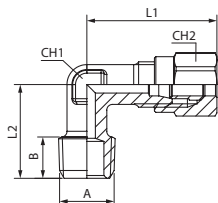

Code	Tube	A	B	L1	L2	CH1	CH2	Pack.
69280 00 001	4	1/8	7.5	23	16.5	9	10	2
69280 00 002	6	1/8	7.5	23	16.5	9	12	2
69280 00 003	6	1/4	11	23	19.5	9	12	2
69280 00 004	8	1/8	7.5	25.5	17	12	14	2
69280 00 005	8	1/4	11	25.5	21	12	14	2
69280 00 006	8	3/8	11.5	25.5	22	12	14	2
69280 00 007	10	1/4	11	33	24.5	14	19	2
69280 00 008	10	3/8	11.5	33	25.5	14	19	2
69280 00 010	12	1/2	14	35	31	17	22	2

Fino ad esaurimento scorte

Until the end stock

Nur solange vorrat

Livrabre jusqu'à épauisement du stock

Hasta fin de stock

Ate fim do stock

## 69280X

### RACCORDO A L MASCHIO

ELBOW MALE ADAPTOR  
WINKELVERSCHRAUBUNG  
EQUERRE MÂLE CONIQUE  
RACOR A L MACHO  
CONEXÃO EM "L" COM ROSCA MACHO

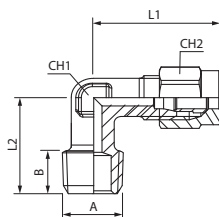

Code	Tube	A	B	L1	L2	CH1	CH2	Pack.
69280 X0 001	4	1/8	7.5	23	16.5	9	10	2
69280 X0 002	6	1/8	7.5	23	16.5	9	12	2
69280 X0 003	6	1/4	11	23	19.5	9	12	2
69280 X0 004	8	1/8	7.5	25.5	17	12	14	2
69280 X0 005	8	1/4	11	25.5	21	12	14	2
69280 X0 006	8	3/8	11.5	25.5	22	12	14	2
69280 X0 007	10	1/4	11	33	24.5	14	19	2
69280 X0 008	10	3/8	11.5	33	25.5	14	19	2
69280 X0 009	12	3/8	11.5	35	27	17	22	2
69280 X0 010	12	1/2	14	35	31	17	22	2

Dado a basso attrito per una chiusura semplificata

Low friction nut for easier tightening

Mutter mit geringer Reibung für leichtere Montage

Ecrou a faible friction pour un serrage plus facile

Tuerca de baja fricción para simplificar el apriete

Porca de baixo atrito para um fechamento simplificado

## 69460

### RACCORDO DIRITTO INTERMEDIO

STRAIGHT CONNECTOR  
VERBINDUNGSVERSCHRAUBUNG  
RACCORD UNION DOUBLE  
RACOR RECTO INTERMEDIO  
CONEXÃO RETA TUBO-TUBO

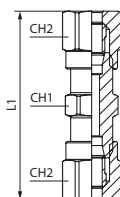

Code	Tube	L1	CH1	CH2	Pack.
69460 00 001	4	36	9	10	2
69460 00 002	6	36.5	11	12	2
69460 00 003	8	40.5	12	14	2
69460 00 004	10	48.5	17	19	2
69460 00 005	12	49.5	19	22	2

Fino ad esaurimento scorte

Until the end stock

Nur solange vorrat

Livrabre jusqu'à épauisement du stock

Hasta fin de stock

Ate fim do stock

## 69460X

**RACCORDO DIRITTO INTERMEDIO**  
 STRAIGHT CONNECTOR  
 VERBINDUNGSVERSCHRAUBUNG  
 RACCORD UNION DOUBLE  
 RACOR RECTO INTERMEDIO  
 CONEXÃO RETA TUBO-TUBO

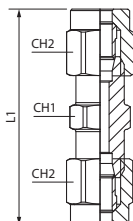

Code	Tube	L1	CH1	CH2	Pack.
69460 X0 001	4	36	9	10	2
69460 X0 002	6	36.5	11	12	2
69460 X0 003	8	40.5	12	14	2
69460 X0 004	10	48.5	17	19	2
69460 X0 005	12	49.5	19	22	2

**Dado a basso attrito per una chiusura semplificata**  
 Low friction nut for easier tightening  
 Mutter mit geringer Reibung für leichtere Montage  
 Ecrou a faible friction pour un serrage plus facile  
 Tuerca de baja fricción para simplificar el apriete  
 Porca de baixo atrito para um fechamento simplificado

## 69480X

**RACCORDO DIRITTO MASCHIO**  
 STRAIGHT MALE ADAPTOR  
 GERADE EINSCHRAUBVERSCHRAUBUNG KONISCH  
 RACCORD DROIT MÂLE CONIQUE  
 RACOR RECTO MACHO  
 CONEXÃO RETA COM ROSCA MACHO

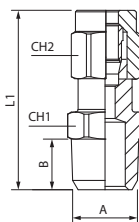

Code	Tube	A	B	L1	CH1	CH2	Pack.
69480 X0 001	4	1/8	7.5	27.5	10	10	2
69480 X0 002	6	1/8	7.5	27.5	10	12	2
69480 X0 003	6	1/4	11	32	14	12	2
69480 X0 004	8	1/8	7.5	30	12	14	2
69480 X0 005	8	1/4	11	33.5	14	14	2
69480 X0 006	8	3/8	11.5	35	17	14	2
69480 X0 007	10	1/4	11	38.5	16	19	2
69480 X0 008	10	3/8	11.5	39.5	17	19	2
69480 X0 009	12	3/8	11.5	40	18	22	2
69480 X0 010	12	1/2	14	42.5	21	22	2

**Dado a basso attrito per una chiusura semplificata**  
 Low friction nut for easier tightening  
 Mutter mit geringer Reibung für leichtere Montage  
 Ecrou a faible friction pour un serrage plus facile  
 Tuerca de baja fricción para simplificar el apriete  
 Porca de baixo atrito para um fechamento simplificado

## 69485

**RACCORDO DIRITTO MASCHIO CILINDRICO CON OR FKM**  
 STRAIGHT MALE ADAPTOR WITH FKM OR  
 GERADE EINSCHRAUBVERSCHRAUBUNG MIT OR FKM  
 RACCORD DROIT MÂLE AVEC OR FKM  
 RACOR RECTO MACHO CON FKM OR  
 CONEXÃO RETA COM ROSCA MACHO COM OR FKM

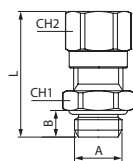

Code	Tube	A	B	L	CH1	CH2	Pack.
69485 00 001	4	1/8	6	26	13	10	2
69485 00 002	6	1/8	6	26	13	12	2
69485 00 003	6	1/4	8	28	15	12	2
69485 00 004	8	1/8	6	27.5	13	14	2
69485 00 005	8	1/4	8	29.5	15	14	2
69485 00 006	8	3/8	9	31.5	20	14	2
69485 00 007	10	1/4	8	34.5	16	19	2
69485 00 008	10	3/8	9	35.5	20	19	2
69485 00 009	12	3/8	9	35.5	20	22	2
69485 00 010	12	1/2	10	37.5	25	22	2

	min	max
<b>Temperature</b>	- 15 °C	+ 190 °C

**Fino ad esaurimento scorte**  
 Until the end stock  
 Nur solange vorrat  
 Livrable jusqu'à épuisement du stock  
 Hasta fin de stock  
 Até fim do stock

## 69485X

### RACCORDO DIRITTO MASCHIO CILINDRICO CON OR FKM

STRAIGHT MALE ADAPTOR WITH FKM OR  
GERADE EINSCHRAUBVERSCHRAUBUNG MIT OR FKM  
RACCORD DROIT MÂLE AVEC OR FKM  
RACOR RECTO MACHO CON FKM OR  
CONEXÃO RETA COM ROSCA MACHO COM OR FKM

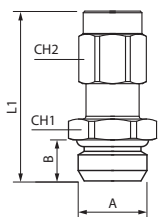

Code	Tube	A	B	L	CH1	CH2	Pack.
69485 X0 001	4	1/8	6	26	13	10	2
69485 X0 002	6	1/8	6	26	13	12	2
69485 X0 003	6	1/4	8	28	15	12	2
69485 X0 004	8	1/8	6	27.5	13	14	2
69485 X0 005	8	1/4	8	29.5	15	14	2
69485 X0 006	8	3/8	9	31.5	20	14	2
69485 X0 007	10	1/4	8	34.5	16	19	2
69485 X0 008	10	3/8	9	35.5	20	19	2
69485 X0 009	12	3/8	9	35.5	20	22	2
69485 X0 010	12	1/2	10	37.5	25	22	2



**Temperature**

**min**      **max**  
- 15 °C      + 190 °C

**Dado a basso attrito per una chiusura semplificata**  
*Low friction nut for easier tightening*  
*Mutter mit geringer Reibung für leichtere Montage*  
*Ecrou a faible friction pour un serrage plus facile*  
*Tuerca de baja fricción para simplificar el apriete*  
*Porca de baixo atrito para um fechamento simplificado*

## 69680

### DADO

NUT  
ÜBERWURFMUTTER  
ECROU  
TUERCA  
PORCA

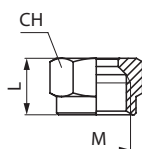

Code	Tube	L	CH	M	Pack.
69680 00 44 X1 L2	4 LL	11	10	M8x1	10
69680 00 44 X4 L2	6 LL	11.5	12	M10x1	10
69680 00 44 X7 L2	8 LL	12	14	M12x1	10
69680 00 44 X9 L2	10 L	15.5	19	M16x1.5	10
69680 00 44 Y1 L2	12 L	15.5	22	M18x1.5	10

**Dado a basso attrito per una chiusura semplificata**  
*Low friction nut for easier tightening*  
*Mutter mit geringer Reibung für leichtere Montage*  
*Ecrou a faible friction pour un serrage plus facile*  
*Tuerca de baja fricción para simplificar el apriete*  
*Porca de baixo atrito para um fechamento simplificado*

COPPIE DI SERRAGGIO DADO SU OGIVA TORQUE FORCE ON OLIVE NUT ANZUGSDREHMOMENT ZWISCHEN MUTTER UND KLEMMRING COUPLE DE SERRAGE DE L'ÉCROU SUR LA BAGUE OLIVE PAR DE APRIETE DE LA TUERCA DE OJIVA TORQUE DE APERTO PARA PORCA EM BUCHA		
∅	N.m	Kgf.m
mm		
4	5	0.51
6	15	1.53
8	25	2.55
10	45	4.59
12	60	6.12

Forze di serraggio, minime consigliate, e n° di giri utili, per garantire un montaggio corretto.  
*Torque force, minimum recommended, and usefull turn, to ensure a correct installation.*  
*Empfohlenes anzugsdrehmoment und mindest umdrehungsanzahl für eine korrekte montage.*  
*Couple de serrage minimum recommandé et nombre de tours pour assurer une installation correcte.*  
*Par de apriete mínimo recomendado y n. giros necesarios para garantizar un montaje correcto.*  
*Torque de aperto mínimo garantido, n. rotação necessário para garantir a correcta instalacao.*

**69740**

**OGIVA**  
 OLIVE  
 KLEMMRING  
 BAGUE BICÔNE  
 BICONO  
 BUCHA



Code	Tube	L	Pack.
69740 00 44 X1 00	4 LL	6	10
69740 00 44 X4 00	6 LL	7	10
69740 00 44 X7 00	8 LL	7.5	10
69740 00 44 X9 00	10 L	9.5	10
69740 00 44 Y1 00	12 L	9.5	10

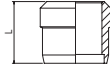

**69770**

**BUSSOLA DI RINFORZO**  
 INTERNAL SUPPORT BUSH  
 STÜTZHÜLSE EDELSTAHL  
 FOURRURE INTÉRIEURE  
 REFUERZO  
 BUCHA DE REFORÇO INTERNA



Code	Tube	A	B	C	L	Pack.
69770 00 44 1D 00	4/2.7	2.7	2.1	3.2	10	10
69770 00 44 3D 00	6/4	4	3.2	5.2	12	10
69770 00 44 4D 00	8/6	6	5.2	7.3	14	10
69770 00 44 5D 00	10/8	8	7	8.9	16	10
69770 00 44 8D 00	12/10	10	9	10.9	16	10

**MATERIALE: Acciaio Inox AISI 304 - EN 1.4301**

MATERIAL: Stainless Steel AISI 304 - EN 1.4301

MATERIAL: Edelstahl AISI 304 - EN 1.4301

MATÉRIEL: Acier Inoxydable AISI 304 - EN 1.4301

MATERIAL: Acero Inoxidable AISI 304 - EN 1.4301

MATERIAL: Aço Inoxidável AISI 304 - EN 1.4301

