

**SERIE 410 - 510 FRENCH PROFILE DN8**

**412**

**INNESTO FEMMINA**

FEMALE PLUG  
 STECKER MIT INNENGEWINDE  
 EMBOUT FEMELLE  
 ADAPTADOR HEMBRA  
 PLUG COM ROSCA FÊMEA

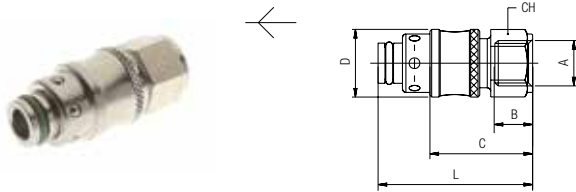

Code	A	B	C	D	L	CH	Pack.
00412 00 001	1/4	11	30	20	47	17	10

**415**

**INNESTO CON PORTAGOMMA DIRITTO**

STRAIGHT BARBED PLUG  
 STECKER MIT SCHLAUCHTÜLLE  
 EMBOUT À DOUILLE ANNELÉE  
 ADAPTADOR CON PORTAGOMA RECTO  
 PLUG COM ESPIGÃO PARA TUBO DE BORRACHA RETO

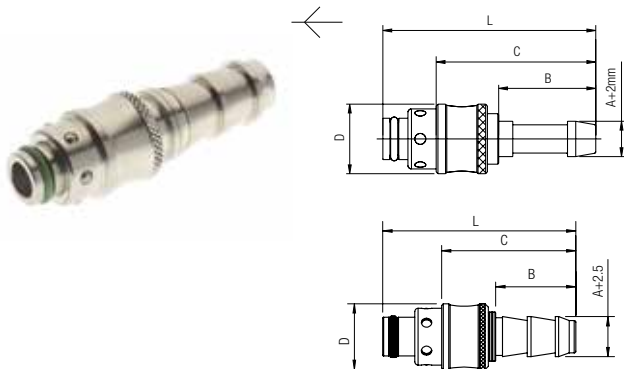

Code	A	B	C	D	L	Pack.
00415 00 001	8	27.5	45	20	62.5	10
00415 00 002	10	27.5	45	20	62.5	10
00415 00 003	12	33	50.5	20	68	10

Code	A	B	C	D	L	Pack.
00415 00 004	3/8	24	48	20	60	10
00415 00 005	1/2	28	54.5	20	66	10

**416**

**INNESTO CON PORTAGOMMA A 135°**

BARBED PLUG 135°  
 STECKER MIT SCHLAUCHTÜLLE VON 135°  
 EMBOUT À 135°, À DOUILLE ANNELÉE  
 ADAPTADOR CON PORTAGOMA A 135°  
 PLUG COM ESPIGÃO PARA TUBO DE BORRACHA A 135°

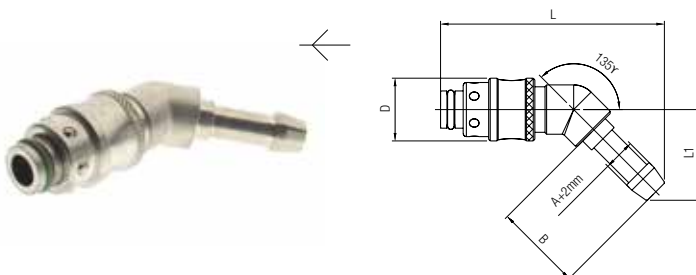

Code	A	B	C	L	L1	Pack.
00416 00 001	8	27.5	20	72.5	28.5	10
00416 00 002	10	27.5	20	73	29	10
00416 00 003	12	33	20	77.5	33.5	10

## 418

### INNESTO CON PORTAGOMMA A 90°

BARBED PLUG 90°

STECKER MIT SCHLAUCHTÜLLE VON 90°

EMBOUÏ À 90°, À DOUILLE ANNELÉE

ADAPTADOR CON PORTAGOMA A 90°

PLUG COM ESPIGÃO PARA TUBO DE BORRACHA A 90°

Code	A	B	C	D	L	L1	Pack.
00418 00 001	8	27.5	39.5	20	57	49	10
00418 00 002	10	27.5	39.5	20	57	49	10
00418 00 003	12	33	39.5	20	57	55	10

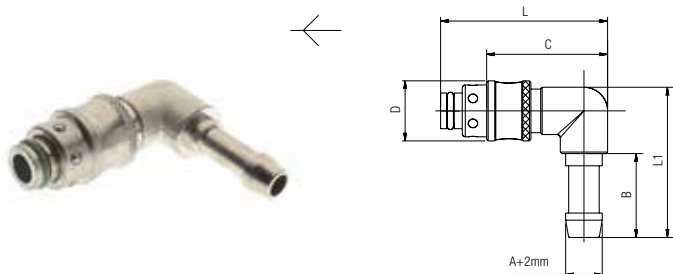

## 511

### PRESA MASCHIO

MALE SOCKET

VERSCHLUSS-KUPPLUNG MIT AUSSENGEWINDE

COUPLEUR MÂLE

ENCHUFE MACHO

SOQUETE COM ROSCA MACHO

Code	A	B	C	L	CH	Pack.
00511 00 001	1/8	6	21	27.5	5	10
00511 00 002	1/4	8	21	29	8	10
00511 00 003	3/8	9	21	30	10	10

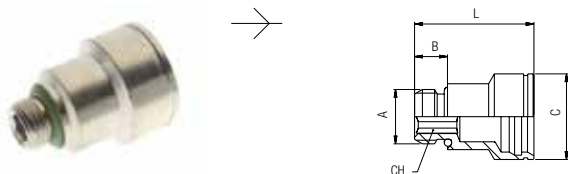

## 512

### PRESA PROLUNGATA MASCHIO

EXTENDED MALE SOCKET

SCHNELLKUPPLUNG MIT VERLÄNGERTEM AUSSENGEWINDE

COUPLEUR MÂLE RALLONGÉ

ENCHUFE PROLONGADO MACHO

SOQUETE COM ROSCA MACHO PROLONGADA

Code	A	B	C	D	L	CH	Pack.
00512 00 01 NU NT	1/8	27	21	21	50	5	10
00512 00 01 NV NT	1/8	60	21	21	100	5	10
00512 00 01 NW NT	1/8	60	21	21	150	5	10
00512 00 01 NX NT	1/8	60	21	21	200	5	10
00512 00 01 NY NT	1/4	27	21	20	50	8	10
00512 00 01 NZ NT	1/4	60	21	20	100	8	10
00512 00 01 PA NT	1/4	60	21	20	150	8	10
00512 00 01 PB NT	1/4	60	21	20	200	8	10
00512 00 01 PC NT	3/8	35	21	11	50	10	10
00512 00 01 PD NT	3/8	60	21	11	100	10	10
00512 00 01 PE NT	3/8	60	21	11	150	10	10
00512 00 01 PF NT	3/8	60	21	11	200	10	10

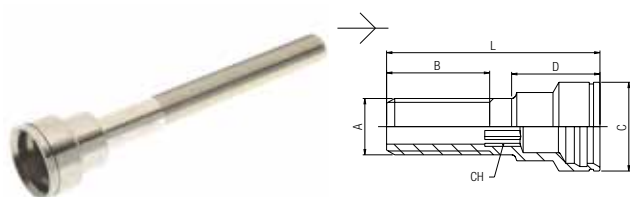

## 514

### PRESA MASCHIO CONICO

MALE SOCKET TAPER

VERSCHLUSS-KUPPLUNG MIT AUSSENGEWINDE KONISCH

COUPLEUR MÂLE CONIQUE

ENCHUFE MACHO CÓNICO

SOQUETE COM ROSCA MACHO

Code	A	B	C	L	CH	Pack.
00514 00 01 02 TF	1/8	7.5	21	28	5	10
00514 00 01 03 TF	1/4	11	21	31	8	10
00514 00 01 04 TF	3/8	11.5	21	31	10	10

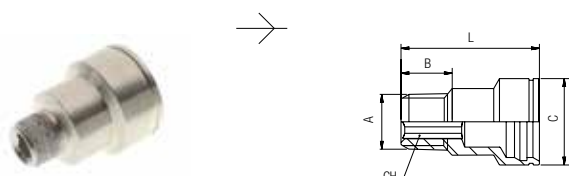



Filetto Pre Sigillato  
Pre-Coating Thread  
GEWINDE BESCHICHTET  
Pré-Coating  
Rosca Presellada  
Rosca Teflonada

# 513

## ANELLO DI RICONOSCIMENTO

IDENTIFICATION RING  
 KENNZEICHNUNGSRING  
 ANNEAU D'IDENTIFICATION  
 ANILLO DE IDENTIFICACIÓN  
 ANEL DE IDENTIFICAÇÃO

Code	Color	A	B	C	Pack.
00513 RO		4.5	22	24.5	10
00513 BL		4.5	22	24.5	10
			<b>min</b>	<b>max</b>	
 <b>Temperature</b>			- 15 °C	+ 110 °C	

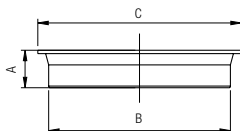

**Dimensioni sede per presa 511**  
 Seat dimensions for 511 socket  
 Einbaumasse für Kupplung 511  
 Dimensions pour coupleur 511  
 Dimensiones para la sede enchufe 511  
 Dimensões da sede para soquete 511

Size	D	P	F
1/8	22	22	6
1/4	22	21.5	8
3/8	22	21.5	9

