

 6300 Pag. 12.9	 6305 - FKM Pag. 12.9	 6310 Pag. 12.9	 6315 - FKM Pag. 12.9	 6320 Pag. 12.9	 6330 Pag. 12.10	 6340 Pag. 12.10	 6350 Pag. 12.10	 6400 Pag. 12.11
 6405 - FKM Pag. 12.11	 6410 Pag. 12.11	 6415 - FKM Pag. 12.11	 6420 Pag. 12.11	 6430 Pag. 12.12	 6440 Pag. 12.12	 6450 Pag. 12.13	 6460 Pag. 12.13	 6470 Pag. 12.13
 6490 Pag. 12.14	 6500 Pag. 12.14	 6540 Pag. 12.14	 6560 Pag. 12.15	 6570 Pag. 12.15	 6600 Pag. 12.15	New  6630 Pag. 12.16	 86300 Pag. 12.16	 86310 Pag. 12.16
 66300 Pag. 12.18	New  66301 Pag. 12.19	 66310 Pag. 12.19	New  66311 Pag. 12.19	 66560 Pag. 12.20	 66570 Pag. 12.20	 6315 Pag. 12.22	 6700 Pag. 12.24	 6710 Pag. 12.25
 6720 Pag. 12.25	 6730 Pag. 12.26	New  6900 Pag. 12.27	New  6910 Pag. 12.27	 6915 Pag. 12.27	 6920 Pag. 12.28	 6680 Pag. 12.28	 10740 Pag. 12.28	 10741 Pag. 12.29
 10760 Pag. 12.29	 10761 Pag. 12.29	 6065 Pag. 12.31	 6066 Pag. 12.31	New  6065X Pag. 12.34	New  6066X Pag. 12.34	 6067 Pag. 12.36	 6068 Pag. 12.37	 6069 Pag. 12.37
 6074 Pag. 12.40	 6075 Pag. 12.41	 6750L Pag. 12.43	 6755L Pag. 12.44	 6760L Pag. 12.44	 6765L Pag. 12.45	 LUC01 Pag. 12.45	 6035 Pag. 12.47	 6036 Pag. 12.49
 6037 Pag. 12.49	 6038 Pag. 12.49							

VALVOLE A SFERA

BALL VALVES

KUGELHÄHNE

ROBINETS A BOISSEAU SPHÉRIQUE

VÁLVULAS A ESFERA

VÁLVULAS DE ESFERA

Serie Ghilux



Inventate e ingegnerizzate da Aignep le valvole a sfera Ghilux sono state una rivoluzione già negli anni 90'. Di minimi ingombri e performanti queste micro valvole sono la risposta ottimale alla crescente richiesta di miniaturizzazione. Disponibili a 2 e 3 vie, con sfiato e attraversamento parete sono disponibili in ben 25 modelli differenti, possono intercettare differenti tipologie di fluidi. Possibilità di realizzare rubinetti con tenute differenti in FKM, EPDM e HNBR. Versione in Aisi 316L. A completamento dell'offerta Aignep dispone di rubinetti a 2 e 3 vie di dimensioni tradizionali.

Principali vantaggi

- A 2 e 3 vie e con spurgo
- Da 1/8 a 3/4 nelle filettature BSPP, BSPT e NPT
- Passaparete
- Tenute differenti in base alle applicazioni
- Leggerezza ed ingombro ridotto
- Inerti intercambiabili colorati per identificazione
- Silicon Free

Applicazioni

- Aria Compressa e Strumenti
- Automazione Pneumatica
- Intercettazione Fluidi
- Food & Beverage
- Life & Sciences
- Gas inerti, vuoto
- Settore Termoidraulico

The GHILUX miniature ballvaves have been created and engineered by Aignep in the 90's. The supercompact dimensions and the excellent performance respond to the growing demand of miniaturization.

Many available version: 2 or 3-ways, with exhaust, push-in, compression, etc.

25 different configurations to drive multiple fluids. On demand FKM, EPDM and HNBR.

To complete the range traditional ball valves.

Main advantages

- 2-3 ways with exhaust
- Threads 1/8 to 3/4 - BSPP, BSPT, NPT
- Bulkhead
- Multiple fluids
- Supercompact dimension
- Coloured plates for Identification
- Silicon Free

Applications

- Compressed Air, Tools
- Pneumatic Automation
- Fluidtechnology
- Food & Beverage
- Life & Sciences
- Inert Gases, Vacuum
- Plumbing

Die GHILUX Miniatur-Kugelhähne wurden in den 90er Jahren von Aignep entwickelt und kreiert.

Die superkompakten Abmessungen und die ausgezeichnete Leistung antworten auf die wachsende Nachfrage nach Miniaturisierung. Viele erhältliche Versionen: 2 oder 3-Wege, mit Entlüftung, mit Steckanschluss, etc.

25 verschiedene Konfigurationen für den Transport vieler Medien. Auf Anfrage FKM, EPDM und HNBR Dichtungen. Als Ergänzung zum traditionellen Kugelhahn Sortiments.

Hauptvorteile

- 2-3 Wege mit Entlüftung
- Gewinde 1/8 bis 3/4" - BSPP, BSPT, NPT
- Schottmontage
- Verschiedene Medien
- Superkompakte Abmessung
- Farbige Schilder zur Kennzeichnung
- Silikonfrei

Anwendungen

- Druckluft, Werkzeuge
- Pneumatische Automation
- Fluidtechnik
- Lebensmittel & Getränke
- Life Sciences
- Inertgase, Vakuum
- Sanitär

Les robinets à boisseau sphérique GHILUX ont été conçus par Aignep dans les années 90. L'extrême compacité et l'excellente performance des produits répondent aux demandes croissantes dans la miniaturisation. Nombreuses versions disponibles: 2 ou 3 voies, avec échappement, raccordement instantané, à olive, etc. 25 configurations différentes pour transporter différents fluides. Version avec joint FKM, EPDM et HNBR sur demande. Les robinets GHILUX complètent notre offre de robinets standards à boisseau sphérique.

Principaux avantages

- 2-3 voies, male -femelle- avec échappement
- Filetages de 1/8 à 3/4 - BSPP, BSPT, NPT
- A traversée de cloison
- Nombreux fluides
- Extrême compacité
- Plaques de couleur pour l'identification des circuits
- Sans Silicone

Applications

- Air comprimé
- Automatisatismes pneumatiques
- Agro alimentaire
- Laboratoire
- Life & Sciences
- Gaz neutres, vide
- Plomberie

Inventadas y desarrolladas por Aignep las válvulas de esfera Ghilux eran ya una revolución en los años 90'. De reducidas dimensiones y excelente rendimiento estas micro válvulas son la respuesta óptima a la creciente demanda de miniaturización. Disponibles de 2 y 3 vías, con escape, automáticas, pasatabiques, compresión, 25 diferentes configuraciones para interceptar diferentes tipologías de fluidos. Posibilidad bajo demanda en FKM, EPDM y HNBR. Versión en Inox AISI 316L. Para completar la gama Aignep dispone de válvulas de esfera 2 y 3 vías de dimensiones tradicionales.

Principales ventajas

- A 2 y 3 vías y con escape
- De 1/8 a 3/4 con roscas BSPP, BSPT y NPT
- Pasatabiques
- Estanqueidad diferente en base a las aplicaciones
- Ligereza y dimensiones reducidas
- Insertos intercambiables de color para identificación
- Libres de silicone

Aplicaciones

- Aire comprimido y herramientas
- Automatización neumática
- Interceptación de fluidos
- Alimentos y bebidas
- Life & Sciences
- Gases inertes, vacío
- Sector termo hidráulico

As válvula-esfera miniatura da série GHILUX foram criadas e desenvolvidas pela Aignep nos anos 90. As dimensões super-compactas e a excelente performance, atende ao crescimento de demanda de miniaturização solicitada pelo mercado moderno. Várias versões estão disponíveis: 2 ou 3-vias, com exaustão, conexão push-in, conexão de compressão, etc. 25 configurações diferentes para conduzir múltiplos fluidos. Sob encomenda: vedações em FKM, EPDM e HNBR para completar o range tradicional das válvulas-esfera.

Principais vantagens

- 2-3 vias com escape
- Roscas de 1/8 a 3/4 - BSPP, BSPT, NPT
- Modelo passa-muro
- Múltiplos fluidos
- Dimensões Super-compactas
- Linguetas coloridas para fácil identificação
- Livre de Silicone

Aplicações

- Ar Comprimido, Ferramentas
- Automação Pneumática
- Fluidos
- Alimentos e Bebidas
- Life & Sciences
- Gases Inertes, Vácuo
- Encanamento

VALVOLE A SFERA

BALL VALVES
KUGELHÄHNE
ROBINETS A BOISSEAU SPHÉRIQUE
VÁLVULAS A ESFERA
VÁLVULAS DE ESFERA



CARATTERISTICHE TECNICHE

TECHNICAL CHARACTERISTICS
TECHNISCHE ANGABEN
CARACTÉRISTIQUES TECHNIQUES
CARACTERÍSTICAS TÉCNICAS
CARACTERÍSTICAS TÉCNICAS



Norma di Riferimento

Reference standard
Entspricht der Norm
Norme de référence
Normativa de referencia
Norma de referência

1907/2006
REACH

2011/65/CE
RoHS

BS EN
331:2015

PED
2014/68/UE

**SILICON
FREE**

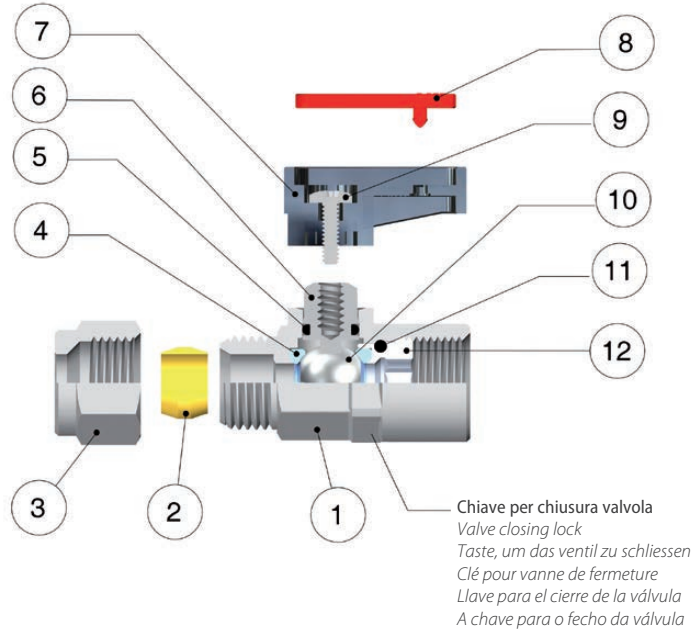

*** FKM - EPDM - HNBR A RICHIESTA**
IF REQUESTED FKM - EPDM - HNBR
FKM - EPDM - HNBR AUF ANFRAGE
FKM - EPDM - HNBR SUR DEMANDE
FKM - EPDM - HNBR BAJO PEDIDO
FKM - EPDM - HNBR SOB ENCOMENDA

Materiali e Componenti	IT	Component Parts and Materials	GB	Komponenten und Materialien	DE
1 Corpo in Ottone cromato		1 Chrome Nickel-plated Brass Body		1 Körper Messing verchromt	
2 Ogiva in Ottone (PTFE a richiesta)		2 Brass Olive (if requested PTFE)		2 Klemmring Messing (PTFE auf Anfrage)	
3 Dado in Ottone cromato		3 Chrome Nickel-plated Brass Nut		3 Überwurfmutter Messing verchromt	
4 Guarnizione sede sfera in PTFE		4 PTFE Seats		4 Kugelsitzdichtung PTFE	
5 Guarnizione O-RING in NBR (FKM-EPDM-HNBR a richiesta)		5 NBR Seal O-RING (FKM-EPDM-HNBR if required)		5 O-Ring NBR (FKM-EPDM-HNBR auf Anfrage)	
6 Albero in Ottone cromato		6 Chrome Nickel-plated Brass Spindle		6 Spindel Messing verchromt	
7 Maniglia in PA66 Caricato vetro		7 PA66 Glass reinforced Handle		7 Handgriff PA66 Glasfaser verstärkt	
8 Piastrina in Resina Acetalica		8 Acetalic resin Plate		8 Griffplatte Acetal	
9 Vite in acciaio		9 Steel Screw		9 Schraube Stahl	
10 Sfera in Ottone cromato		10 Chrome Nickel-plated Brass Ball		10 Kugel Messing verchromt	
11 Guarnizione O-RING in NBR*		11 NBR Seal O-RING*		11 O-Ring NBR*	
12 Ghiera o raccordo in Ottone		12 Brass Fitting		12 Gewindeinsatz Messing	
Matériaux et Composants	FR	Materiales y Componentes	ES	Materiais e Componentes	PT
1 Corps: laiton chromé		1 Cuerpo en latón cromado		1 Corpo em Latão Cromado	
2 Bague: laiton (sur demande en PTFE)		2 Bicono en latón (PTFE bajo demanda)		2 Bucha em Latão (PTFE sob encomenda)	
3 Ecrou: laiton nickelé		3 Tuerca en latón cromado		3 Porca em Latão Cromado	
4 Joint bille sphérique: PTFE		4 Junta sede esfera en PTFE		4 Vedação da sede da esfera em PTFE	
5 Joint tige NBR (sur demande en FKM-EPDM-HNBR)		5 Junta tórica O-RING en NBR (FKM-EPDM-HNBR bajo demanda)		5 Vedação O-RING em NBR (FKM-EPDM-HNBR sob encomenda)	
6 Tige: laiton chromé		6 Eje en latón cromado		6 Eixo em Latão Cromado	
7 Poignée en PA66 chargé en fibre de verre		7 Maneta en PA66 con fibra de vidrio		7 Manopla em PA66 e fibra de vidro	
8 Plaquette de poignée: résine acétal		8 Plaqueta en PA6		8 Piaqueta de Resina Acetalica	
9 Vis: acier		9 Tornillo en acero		9 Parafuso em aço	
10 Bille: laiton chromé		10 Esfera en latón cromado		10 Esfera em Latão Cromado	
11 Joint torique NBR*		11 Junta tórica O-RING en NBR*		11 Vedação O-RING em NBR*	
12 Ecrou de blocage: laiton		12 Racor en latón		12 Conexões em Latão	



Filettatura Gas conforme ISO 7.1, BS 21, DIN 2999 Gas cilíndrica conforme ISO 228 Classe A. NPTF metrica conforme ANSI B1.20.5	IT	Threads Gas in conformity with ISO 7.1, BS 21, DIN 2999. Parallel gas in conformity with ISO 228 Class A. Metric NPTF conformity with ANSI B1.20.5	GB	Gewindearten Gewinde nach Norm ISO 7.1, BS 21, DIN 2999. Zylindrisches Gewinde nach Norm ISO 228 Classe A. Metrisches NPTF nach Norm ANSI B1.20.5	DE
Filetages Filetage conforme: ISO 7.1, BS 21, DIN 2999. Filetage cylíndrique conforme: ISO 228 Classe A. NPTF métrique conforme ANSI B1.20.5	FR	Roscas Gas conforme ISO 7.1, BS 21, DIN 2999 Gas cilíndrica conforme ISO 228 Classe A. NPTF Métrica conforme ANSI B1.20.5	ES	Roscas Gas conforme ISO 7.1, BS 21, DIN 2999. Gas paralela conforme ISO 228 Classe A. NPTF Métrica conforme ANSI B1.20.5	PT



Temperature

- Temperatures
- Temperatur
- Températures
- Temperaturas
- Temperaturas

- 20 °C	FKM	EPDM	HNBR
+ 80 °C	- 15 °C	- 40 °C	- 30 °C
	+ 130 °C	+ 130 °C	+ 130 °C



Pressioni

- Pressures
- Druckbereich
- Pressions
- Presiones
- Pressões

-0.99 bar (-0.099 MPa)
20 bar (2 MPa)



Diagramma pressione - temperatura

- Pressure - temperature ratings diagram
- Druck - temperatur diagramm
- Diagramme pression - température
- Diagrama presión-temperatura
- Diagrama de pressão-temperatura

— PTFE + FKM
 - - - PTFE + NBR

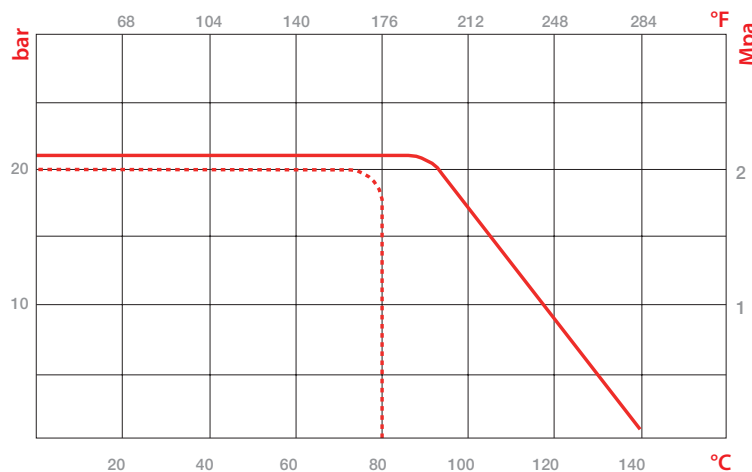

Fluidi compatibili

- Aria compressa / Acqua / Oli
- 1ª e 2ª famiglia di gas a media pressione.
- 3ª famiglia di gas a bassa pressione.
- Fluids**
- Compressed air / Water / Oils
- 1st and 2nd family gases at medium pressure.
- 3rd family gases at low pressure.
- Geeignete Medien**
- Druckluft / Wasser / Oel
- 1. und 2. Familie von Gasen für Mitteldruck.
- 3. Familie von Gasen für Niederdruck.
- Fluides compatibles**
- Air comprimé / Eau / Huile
- Famille 1 et 2 des gaz à moyenne pression.
- Famille 3 des gaz à base pression.
- Fluidos compatibles**
- Aire comprimido / Agua / Aceite
- 1ª y 2ª familia de gases a media presión.
- 3ª familia de gas a baja presión.
- Fluidos compatíveis**
- Ar comprimido / Água / Óleos
- 1ª e 2ª família de gás a média pressão.
- 3ª família de gás a baixa pressão.



Caratteristiche di flusso per aria

Curve caratteristiche di flusso per aria relative alle valvole a sfera ghilux art. 6400 Femmina-femmina

IT

Characteristic curves of flow

Characteristic curves of flow for air pertinent to the ball valves ghilux art. 6400 Female-female

GB

Durchflusskennlinien für druckluft

Durchflusskennlinien für druckluft angegeben für die kugelhähne ghilux art. 6400 Innen-/innengewinde

DE

Diagramme de valeur

Diagramme de valeur du debit pour robinet ghilux art. 6400

FR

Curva característica de flujo

Curva característica de flujo para aire relativo a las válvulas a esfera ghilux art.6400 Hembra-hembra

ES

Curvas características de vazão

Curvas características de vazão para ar relativas às válvulas de esfera ghilux cód. 6400 Fêmea-fêmea

PT

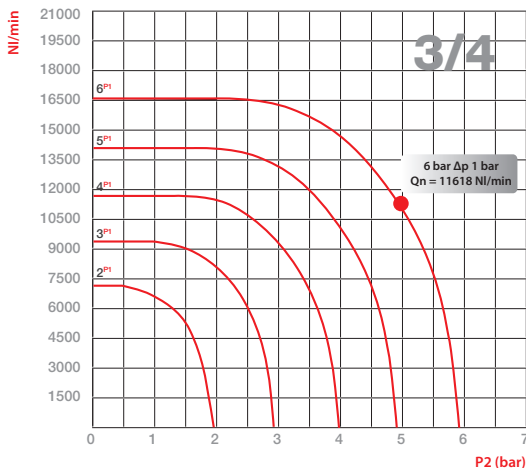
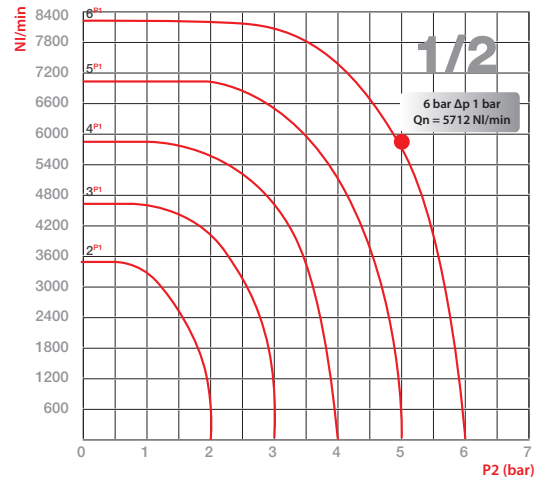
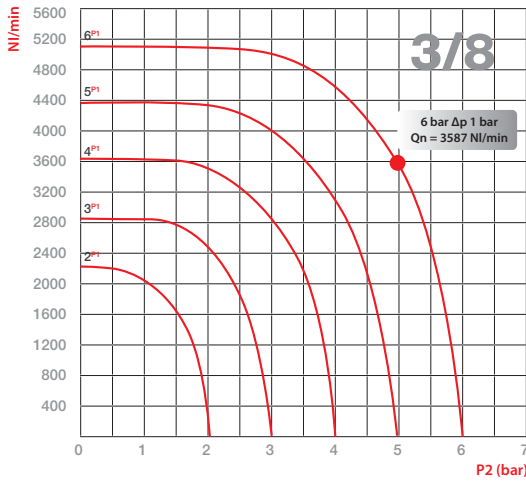
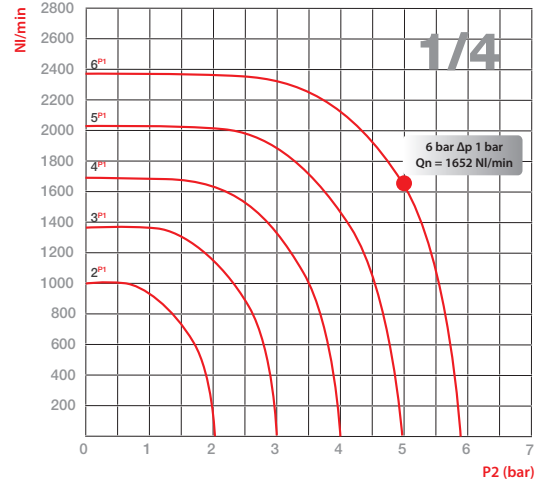
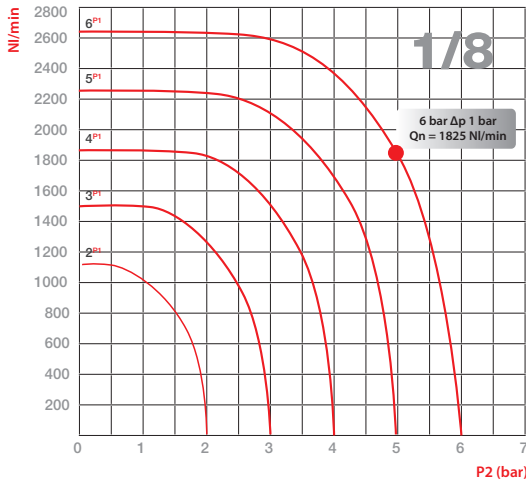

NI/min

Portata
Flow rate
Durchfluss
Débit
Caudal
Vazão

P1 (bar)

Pressione di entrata
Inlet Pressure
Eingangsdruck
Pression d'entrée
Presión de entrada
Pressão de entrada

P2 (bar)

Pressione in uscita
Outlet Pressure
Eingangsdruck
Pression de sortie
Presión de Entrada
Pressão de Entrada



Diagramma portata-perdita di carico

Curve caratteristiche di flusso per aria relative alle valvole a sfera ghilux art. 6400 Femmina-femmina

IT

Diagram of the flow rate and pressure drop

Diagram of the flow rate and pressure drop characteristics pertinent to the ball valves ghilux art.6400 Female-female for water

GB

Durchfluss- und druckabfalldiagramm

Durchfluss- und druckabfalldiagramm für wasser angegeben für die kugelhähne ghilux art. 6400 Innen-/innengewinde

DE

Diagramme debit et perte de charge

Diagramme debit et perte de charge pour robinet ghilux art. 6400 Femelle/femelle

FR

Diagrama de caudal-pérdida de carga

Diagrama de las características caudal-pérdida de carga relativo a las válvulas a esfera art.6400 Hembra-hembra para agua

ES

Diagrama de vazão-perda de carga

Diagrama da característica de vazão-perda de carga relativo às válvulas de esfera ghilux cód. 6400 Fêmea-fêmea para água

PT

Misura Size Größe Dimension Medida Tamanho	Coefficiente di portata idraulica Factor of Hydraulic flow rate Hydraulische Durchflusskoeffizienten Coefficient du débit hydraulique Coeficiente de caudal hidráulico Coeficiente de vazão hidráulica	
	Kv (Kg/h)	m ³ /h
1/8"	1614	1,6
1/4"	1461	1,4
3/8"	3164	3,1
1/2"	5051	5
3/4"	10274	10,2

ΔP (DAPA)

Perdita di carico
Pressure drop
Druckabfall
Perte de charge
Pérdida de carga
Perda de carga

Kv (Kg/h)

Portata
Flow rate
Durchfluss
Débit
Caudal
Vazão

1 DAPA = 1,019 mm H₂O

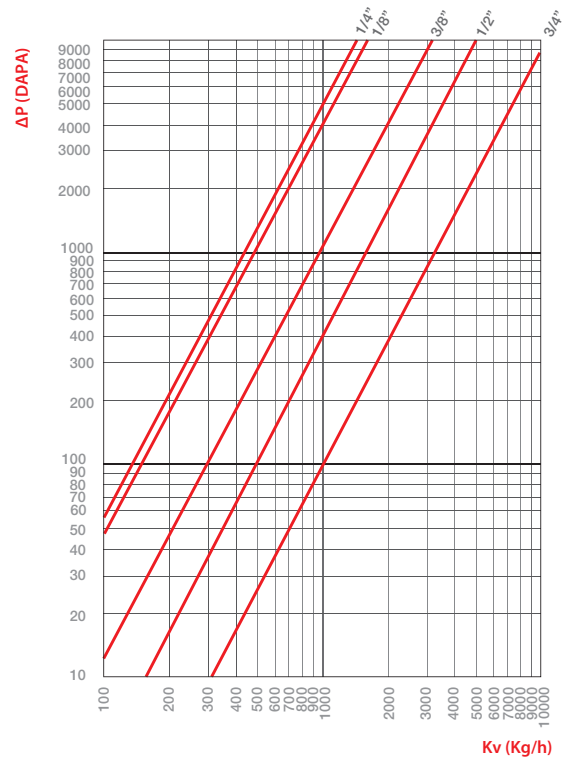

Coefficienti di Portata Kv

Ripartiamo in tabella il coefficiente di portata Kv delle valvole a sfera GHILUX, ricordando che tale coefficiente rappresenta la quantità d' acqua che attraversa la valvola nell'unità di tempo (Kg/h) alla temperatura di 15,5° C e che determina una caduta di pressione unitaria.

IT

Flow Rate Factors Kv

On the following table we specify the flow rate factor Kv of the ball valves GHILUX, we remind You that this factor represent the quantity of water that cross the valve in the unit time (Kg/h) at the temperature of 15.5° C and it determines a drop of unitary pressure.

GB

Durchflusskoeffizienten Kv

Die folgende Tabelle zeigt den Durchflusskoeffizienten Kv der GHILUX Kugelhähne. Dieser Faktor steht für die Wassermenge, welche den Kugelhahn in der Zeiteinheit (Kg/h) bei einer Temperatur von ca. 15,5° C durchfließt und er bestimmt einen einheitlichen Druckabfall.

DE

Coefficient de Débit Kv

Les valeurs Kv mentionnées sous le tableau sont valables pour les robinets GHILUX. Nous rappelons que le coefficient Kv représente la quantité d'eau traversant le robinet dans l'unité de temps (Kg/h) à la température de 15,5°C déterminant une perte de charge unitaire.

FR

Coefficientes de Caudal Kv

Representamos en la tabla los coeficientes de caudal Kv de las válvulas a esfera serie GHILUX, recordando que este coeficiente representa la cantidad de agua que pasa por la válvula por unidad de tiempo (Kg/h) a la temperatura de 15,5° C y que determina una caída de presión unitaria.

ES

Coefficientes de Vazão Kv

Especificamos na tabela a seguir o coeficiente de vazão Kv das válvulas de esfera GHILUX, recordando que tal coeficiente representa a quantidade de água que atravessa a válvula na unidade de tempo (Kg/h) a uma temperatura de 15,5° C e que determina uma queda de pressão unitária.

PT

Opzioni

Option

Optionen

Options

Opciones

Opções

 CODICE ARTICOLO
ARTICLE CODE
ARTIKEL-NUMMER
CODE ARTICLE
CÓDIGO ARTÍCULO
CÓDIGO DO PRODUTO

 MISURA
SIZE
GRÖSSE
DIMENSIONS
MEDIDA
TAMANHO

 COLORE PIASTRINA
COLOUR OF THE PLATE
GRIFFPLATTEN FARBEN
COULEUR DE LA PLAQUETTE
COLOR PLAQUETA
COR PLAQUETA

 TIPO DI GUARNIZIONE
TYPE OF THE SEAL
ART DER DICHTUNG
TYPE DE JOINT
TIPO DE JUNTA
TIPO DE VEDAÇÃO

 TIPO MANIGLIA
TYPE OF HANDLES
ART DES HANDGRIFFES
TYPE DE POIGNÉE
TIPO DE MANETA
TIPO DE MANETA

 TIPO DI OGIVA
TYPE OF OLIVE
ART DES KLEMMRINGES
TYPE DE BAGUE
TIPO DE BICONO
TIPO DE BUCHA

6430
3/8-3/8
RED PLATE
NBR
BRASS Olive

 Piastrina Rossa
Red Plate
Griffplatte Rot
Plaquette Rouge
Plaqueta Roja
Plaqueta Vermelha

NBR

Maniglia CORTA STANDARD per valvola da 1/8 - 1/4 - 3/8 - 1/2
Maniglia LUNGA STANDARD per Valvola da 3/4

 Standard SHORT Handle for Valve 1/8-1/4-3/8-1/2
Standard LONG Handle for Valve 3/4

 Handgriff KURZ Standard für 1/8-1/4-3/8-1/2
Handgriff LANG Standard für 3/4

 Poignée COURTE en standard pour 1/8-1/4-3/8-1/2
Poignée LONGUE en standard pour 3/4

 Maneta CORTA estándar para válvula de 1/8-1/4 -3/8-1/2
Maneta LARGA estándar para válvula de 3/4

 Manopla CURTA standard para válvula de 1/8-1/4-3/8-1/2
Manopla LONGA standard para válvula de 3/4

Ogiva OTTONE
Brass OLIVE
Klemmring MESSING
Bague LAITON
Bicono LATÓN
Bucha em LATÃO

 Su richiesta
If required
Auf Anfrage
Sur demande
Bajo demanda
Sob encomenda

 Piastrina Blu
Blue Plate
Griffplatte Blau
Plaquette Bleu
Plaqueta Azul
Plaqueta Azul

 Piastrina Verde
Green Plate
Griffplatte Grün
Plaquette Verte
Plaqueta Verde
Plaqueta Verde

 Piastrina Bianca
White Plate
Griffplatte Weiss
Plaquette Blanche
Plaqueta Blanca
Plaqueta Branca

 Piastrina Gialla
Yellow Plate
Griffplatte Gelb
Plaquette Jaune
Plaqueta Amarela
Plaqueta Amarela

GAS:

 Piastrina Gialla EN 331
Yellow Plate EN 331
Griffplatte Gelb EN 331
Plaquette Jaune EN 331
Plaqueta Amarilla EN 331
Plaqueta Amarela EN 331

**FKM
HNBR
EPDM**

Maniglia LUNGA
LONG Handle
Handgriff LANG
Poignée LONGUE
Maneta LARGA
Manopla LONGA

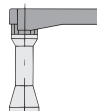
Ogiva PTFE
PTFE Olive
Klemmring PTFE
Bague PTFE
Bicono PTFE
Bucha em PTFE

Maniglia LUNGA con Prolunga albero di comando

 Long HANDLE with Spindle Extension
Handgriff LANG mit verlängerter Schaltwelle

Poignée LONGUE avec arbre rallongé

 Maneta LARGA prolongada
Manopla LONGA com Prolongamento no eixo de comando

6300

VALVOLA FEMMINA RP ISO 7 - FEMMINA RP ISO 7

FEMALE RP ISO 7 - FEMALE RP ISO 7 VALVE
 KUGELHAHN INNENGEW. RP ISO 7 - INNENGEW. RP ISO 7
 ROBINET - TARAUDAGE RP ISO 7
 VÁLVULA HEMBRA RP ISO 7 - HEMBRA RP ISO 7
 VÁLVULA ROSCA FÊMEA RP ISO 7 - ROSCA FÊMEA RP ISO 7

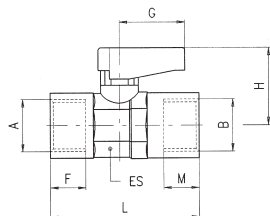

Code	A	B	DN	ES	F	M	L	G	H	Pack.
06300 00 001	1/8	1/8	6	14-15	7.4	7.4	36	19	21	10
06300 00 002	1/4	1/4	6	14-15	11	11	43	19	21	10
06300 00 003	3/8	3/8	8	18-19	11.4	11.4	47	19	22	10
06300 00 004	1/2	1/2	10	22-23	15	15	59	26	30.5	10
06300 00 055	3/4	3/4	14	28-30	16.3	16.3	67	50	33	5
Code FKM										
06305 00 001	1/8	1/8	6	14-15	7.4	7.4	36	19	21	10
06305 00 002	1/4	1/4	6	14-15	11	11	43	19	21	10
06305 00 003	3/8	3/8	8	18-19	11.4	11.4	47	19	22	10
06305 00 004	1/2	1/2	10	22-23	15	15	59	26	30.5	10
06305 00 055	3/4	3/4	14	28-30	16.3	16.3	67	50	33	5

6310

VALVOLA MASCHIO CONICO R ISO 7 - FEMMINA RP ISO 7

TAPER MALE R ISO 7 - FEMALE RP ISO 7 VALVE
 KUGELHAHN AUSSENGEW. KONISCH R ISO 7 - INNENGEW. RP ISO 7
 ROBINET FILETAGE R ISO 7 - TARAUDAGE RP ISO 7
 VÁLVULA MACHO CÓNICO R ISO 7 - HEMBRA RP ISO 7
 VÁLVULA ROSCA MACHO CÔNICA R ISO 7 - ROSCA FÊMEA RP ISO 7

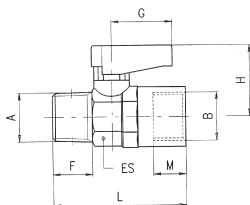

Code	A	B	DN	ES	F	M	L	G	H	Pack.
06310 00 001	1/8	1/8	6	14-15	7.4	7.4	36	19	21	10
06310 00 002	1/4	1/8	6	14-15	11	7.4	40.5	19	21	10
06310 00 003	1/4	1/4	6	14-15	11	11	43	19	21	10
06310 00 004	3/8	3/8	8	18-19	11.4	11.4	46	19	22	10
06310 00 005	1/2	1/2	10	22-23	15	15	57	26	30.5	10
06310 00 066	3/4	3/4	14	28-30	16.3	16.3	63	50	33	5
Code FKM										
06315 00 001	1/8	1/8	6	14-15	7.4	7.4	36	19	21	10
06315 00 002	1/4	1/8	6	14-15	11	7.4	40.5	19	21	10
06315 00 003	1/4	1/4	6	14-15	11	11	43	19	21	10
06315 00 004	3/8	3/8	8	18-19	11.4	11.4	46	19	22	10
06315 00 005	1/2	1/2	10	22-23	15	15	57	26	30.5	10
06315 00 066	3/4	3/4	14	28-30	16.3	16.3	63	50	33	5

6320

VALVOLA MASCHIO CILINDRICO G ISO 228 - FEMMINA RP ISO 7

PARALLEL MALE G ISO 228 - FEMALE RP ISO 7 VALVE
 KUGELHAHN AUSSENGEW. ZYLINDRISCH G ISO 228 - INNENGEW. RP ISO 7
 ROBINET FILETAGE G ISO 228 - TARAUDAGE RP ISO 7
 VÁLVULA MACHO CILÍNDRICO G ISO 228 - HEMBRA RP ISO 7
 VÁLVULA ROSCA MACHO PARALELA G ISO 228 - FÊMEA RP ISO 7

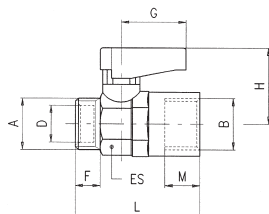

Code	A	B	DN	ES	D	F	M	L	G	H	Pack.
06320 00 001	1/8	1/8	6	14-15	6.2	7	7.4	34.5	19	21	10
06320 00 002	1/4	1/8	6	14-15	8.2	8	7.4	35.5	19	21	10
06320 00 003	1/4	1/4	6	14-15	8.2	8	11	38	19	21	10
06320 00 004	3/8	3/8	8	18-19	10.2	9	11.4	41.5	19	22	10
06320 00 005	1/2	1/2	10	22-23	15.2	10	15	50	26	30.5	10
06320 00 066	3/4	3/4	14	28-30	18.2	12	16.3	56.5	50	33	5

6330

VALVOLA MASCHIO CONICO R ISO 7 - MASCHIO CILINDRICO GA ISO 228

TAPER MALE R ISO 7 - PARALLEL MALE G ISO 228 VALVE
 KUGELHAHN AUSSERGEW. KONISCH R ISO 7 - AUSSERGEW. ZYLINDRISCH GA ISO 228
 ROBINET FILETAGE R ISO 7 - FILETAGE G ISO 228
 VÁLVULA MACHO CÓNICO R ISO 7 - MACHO CILÍNDRICO G ISO 228
 VÁLVULA ROSCA MACHO CÓNICA R ISO 7 - ROSCA MACHO PARALELA GA ISO 228

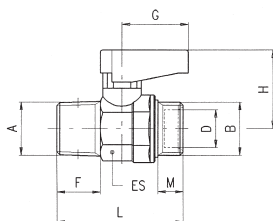

Code	A	B	DN	ES	D	F	M	L	G	H	Pack.
06330 00 001	1/8	1/8	6	14-15	6.2	7.4	7	33.5	19	21	10
06330 00 002	1/8	1/4	6	14-15	8.2	7.4	8	33.5	19	21	10
06330 00 003	1/4	1/8	6	14-15	6.2	11	7	38	19	21	10
06330 00 004	1/4	1/4	6	14-15	8.2	11	8	38	19	21	10
06330 00 005	3/8	3/8	8	18-19	10.2	11.4	9	41.5	19	22	10
06330 00 006	1/2	1/2	10	22-23	15.2	15	10	49	26	30.5	10
06330 00 077	3/4	3/4	14	28-30	18.2	16.3	12	55.5	50	33	5

6340

VALVOLA TUBO - FEMMINA RP ISO 7

TUBE - FEMALE RP ISO 7 VALVE
 KUGELHAHN ROHR - INNENGEW. G ISO 228
 ROBINET TUBE - TARAUDAGE RP ISO 7
 VÁLVULA TUBO - HEMBRA RP ISO 7
 VÁLVULA TUBO - ROSCA FÊMEA RP ISO 7

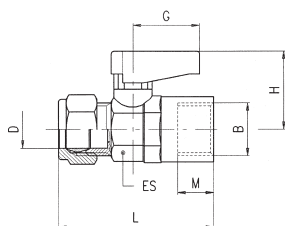

Code	D	B	DN	ES	M	L	G	H	Pack.
06340 00 001	6	1/8	6	14-15	7.4	41.5	19	21	10
06340 00 002	8	1/8	6	14-15	7.4	43	19	21	10
06340 00 003	8	1/4	6	14-15	11	46	19	21	10
06340 00 004	10	3/8	8	18-19	11.4	50.5	19	22	10
06340 00 005	12	3/8	8	18-19	11.4	51.5	19	22	10
06340 00 006	14	1/2	10	22-23	15	61.5	26	30.5	10
06340 00 007	15	1/2	10	22-23	15	61.5	26	30.5	10
06340 00 098	16	3/4	14	28-30	16.3	68	50	33	5
06340 00 099	18	3/4	14	28-30	16.3	68	50	33	5

6350

VALVOLA MASCHIO CONICO R ISO 7 - TUBO

TAPER MALE R ISO 7 - TUBE VALVE
 KUGELHAHN AUSSERGEW. KONISCH R ISO 7 - ROHR
 ROBINET FILETAGE R ISO 7 - TUBE
 VÁLVULA MACHO CÓNICO R ISO 7 - TUBO
 VÁLVULA ROSCA MACHO CÓNICA R ISO 7 - TUBO

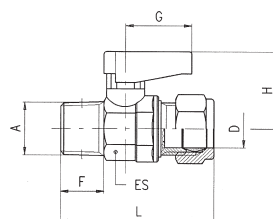

Code	A	D	DN	ES	F	L	G	H	Pack.
06350 00 001	1/8	6	6	14-15	7.4	40.5	19	21	10
06350 00 002	1/8	8	6	14-15	7.4	41.5	19	21	10
06350 00 003	1/4	6	6	14-15	11	46	19	21	10
06350 00 004	1/4	8	6	14-15	11	45	19	21	10
06350 00 005	3/8	10	8	18-19	11.4	50.5	19	22	10
06350 00 006	3/8	12	8	18-19	11.4	51.5	19	22	10
06350 00 007	1/2	14	10	22-23	15	59.5	26	30.5	10
06350 00 008	1/2	15	10	22-23	15	59.5	26	30.5	10
06350 00 109	3/4	16	14	28-30	16.3	67	50	33	5
06350 00 110	3/4	18	14	28-30	16.3	67	50	33	5

6400

VALVOLA FEMMINA G ISO 228 - FEMMINA G ISO 228

FEMALE G ISO 228 - FEMALE G ISO 228 VALVE

KUGELHAHN INNENGEW. G ISO 228 - INNENGEW. G ISO 228

ROBINET TARAUDAGE G ISO 228

VÁLVULA HEMBRA G ISO 228 - HEMBRA G ISO 228

VÁLVULA ROSCA FÊMEA G ISO 228 - ROSCA FÊMEA G ISO 228

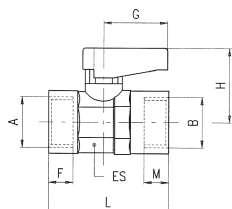

Code	A	B	DN	ES	F	M	L	G	H	Pack.
06400 00 001	1/8	1/8	6	14-15	7	7	35	19	21	10
06400 00 002	1/4	1/4	6	14-15	8	8	37	19	21	10
06400 00 003	3/8	3/8	8	18-19	9	9	42	19	22	10
06400 00 004	1/2	1/2	10	22-23	10	10	49	26	30.5	10
06400 00 055	3/4	3/4	14	28-30	12	12	58	50	33	5
Code FKM										
06405 00 001	1/8	1/8	6	14-15	7	7	35	19	21	10
06405 00 002	1/4	1/4	6	14-15	8	8	37	19	21	10
06405 00 003	3/8	3/8	8	18-19	9	9	42	19	22	10
06405 00 004	1/2	1/2	10	22-23	10	10	49	26	30.5	10
06405 00 055	3/4	3/4	14	28-30	12	12	58	50	33	5

6410

VALVOLA MASCHIO CILINDRICO G ISO 228 - FEMMINA G ISO 228

PARALLEL MALE G ISO 228 - FEMALE G ISO 228 VALVE

KUGELHAHN AUSSENGEW. ZYLINDRISCH G ISO 228 - INNENGEW. G ISO 228

ROBINET FILETAGE G ISO 228 - TARAUDAGE G ISO 228

VÁLVULA MACHO CILÍNDRICO G ISO 228 - HEMBRA G ISO 228

VÁLVULA ROSCA MACHO PARALELA G ISO 228 - ROSCA FÊMEA G ISO 228

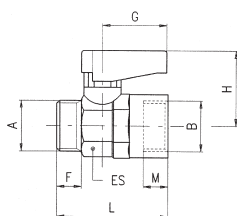

Code	A	B	DN	ES	F	M	L	G	H	Pack.
06410 00 001	1/8	1/8	6	14-15	7	7	34	19	21	10
06410 00 002	1/4	1/8	6	14-15	8	7	35	19	21	10
06410 00 003	1/4	1/4	6	14-15	8	8	35	19	21	10
06410 00 004	3/8	3/8	8	18-19	9	9	39	19	22	10
06410 00 005	1/2	1/2	10	22-23	10	10	45	26	30.5	10
06410 00 066	3/4	3/4	14	28-30	12	12	52	50	33	5
Code FKM										
06415 00 001	1/8	1/8	6	14-15	7	7	34	19	21	10
06415 00 002	1/4	1/8	6	14-15	8	7	35	19	21	10
06415 00 003	1/4	1/4	6	14-15	8	8	35	19	21	10
06415 00 004	3/8	3/8	8	18-19	9	9	39	19	22	10
06415 00 005	1/2	1/2	10	22-23	10	10	45	26	30.5	10
06415 00 066	3/4	3/4	14	28-30	12	12	52	50	33	5

6420

VALVOLA MASCHIO CILINDRICO G ISO 228 - MASCHIO CILINDRICO G ISO 228

PARALLEL MALE G ISO 228 - PARALLEL MALE G ISO 228 VALVE

KUGELHAHN AUSSENGEW. ZYLINDRISCH G ISO 228 - AUSSENGEW. ZYLINDRISCH G ISO 228

ROBINET FILETAGE G ISO 228

VÁLVULA MACHO CILÍNDRICO G ISO 228 - MACHO CILÍNDRICO G ISO 228

VÁLVULA ROSCA MACHO PARALELA G ISO 228 - ROSCA MACHO PARALELA G ISO 228

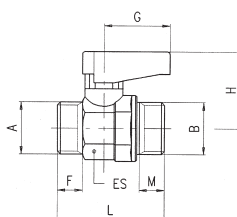

Code	A	B	DN	ES	F	M	L	G	H	Pack.
06420 00 001	1/8	1/8	6	14-15	7	7	32	19	21	10
06420 00 002	1/8	1/4	6	14-15	7	8	32	19	21	10
06420 00 003	1/4	1/4	6	14-15	8	8	33	19	21	10
06420 00 004	3/8	1/4	6	14-15	9	8	33	19	21	10
06420 00 005	3/8	3/8	8	18-19	9	9	37	19	22	10
06420 00 006	1/2	3/8	8	18-19	10	9	37	19	22	10
06420 00 007	1/2	1/2	10	22-23	10	10	42	26	30.5	10
06420 00 008	3/4	1/2	10	22-23	12	10	42	50	30.5	10
06420 00 099	3/4	3/4	14	28-30	12	12	49	50	33	5

6430

VALVOLA TUBO - FEMMINA G ISO 228

TUBE - FEMALE G ISO 228 VALVE
 KUGELHAHN ROHR - INNENGEW. G ISO 228
 ROBINET TUBE - TARAUDAGE G ISO 228
 VÁLVULA TUBO - HEMBRA G ISO 228
 VÁLVULA TUBO - ROSCA FÊMEA G ISO 228

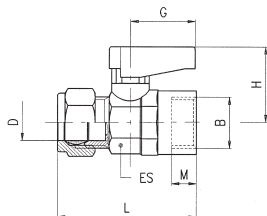

Code	D	B	DN	ES	M	L	G	H	Pack.
06430 00 001	6	1/8	6	14-15	7	41	19	21	10
06430 00 002	8	1/8	6	14-15	7	43	19	21	10
06430 00 003	8	1/4	6	14-15	8	43	19	21	10
06430 00 004	10	3/8	8	18-19	9	48	19	22	10
06430 00 005	12	3/8	8	18-19	9	49	19	22	10
06430 00 006	14	1/2	10	22-23	10	55.5	26	30.5	10
06430 00 007	15	1/2	10	22-23	10	55.5	26	30.5	10
06430 00 098	16	3/4	14	28-30	12	63.5	50	33	5
06430 00 099	18	3/4	14	28-30	12	63.5	50	33	5

6440

VALVOLA MASCHIO CILINDRICO G ISO 228 - TUBO

PARALLEL MALE G ISO 228 - TUBE VALVE
 KUGELHAHN AUSSENGEW. ZYLINDRISCH G ISO 228 - ROHR
 ROBINET FILETAGE G ISO 228 - TUBE
 VÁLVULA MACHO CILÍNDRICO G ISO 228 - TUBO
 VÁLVULA ROSCA MACHO PARALELA G ISO 228 - TUBO

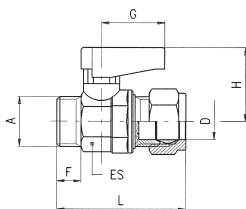

Code	A	D	DN	ES	F	L	G	H	Pack.
06440 00 001	1/8	6	6	14-15	7	39	19	21	10
06440 00 002	1/8	8	6	14-15	7	40	19	21	10
06440 00 003	1/4	6	6	14-15	8	40	19	21	10
06440 00 004	1/4	8	6	14-15	8	41	19	21	10
06440 00 005	1/4	10	6	14-15	8	44	19	21	10
06440 00 006	3/8	8	6	14-15	9	43	19	21	10
06440 00 007	3/8	10	8	18-19	9	46	19	22	10
06440 00 008	3/8	12	8	18-19	9	47	19	22	10
06440 00 009	3/8	14	8	18-19	9	50.5	19	22	10
06440 00 010	3/8	15	8	18-19	9	50.5	19	22	10
06440 00 011	1/2	10	8	18-19	10	49	19	22	10
06440 00 012	1/2	12	8	18-19	10	50	19	22	10
06440 00 013	1/2	14	10	22-23	10	52.5	26	30.5	10
06440 00 014	1/2	15	10	22-23	10	52.5	26	30.5	10
06440 00 015	3/4	14	10	22-23	12	56.5	26	30.5	10
06440 00 016	3/4	15	10	22-23	12	56.5	26	30.5	10
06440 00 197	3/4	16	14	28-30	12	60.5	50	33	5
06440 00 198	3/4	18	14	28-30	12	60.5	50	33	5

Nelle misure 1/4-8, 1/4-10, 3/8-14, 3/8-15 il dado, il bicono e il filetto A sono all'opposto della figura.
 In the sizes 1/4-8, 1/4-10, 3/8-14, 3/8-15 the nut, the double cone and the thread A are at the opposite side of the picture.

In den Größen 1/4-8, 1/4-10, 3/8-14, 3/8-15 sind die Überwurfmutter mit dem Klemmring und das Gewinde A auf der gegenüberliegenden Seite des Bildes.

Pour les dimensions 1/4-8, 1/4-10, 3/8-14, 3/8-15, le filetage A et le raccord sont inversés par rapport à l'image.

En las medidas 1/4-8, 1/4-10, 3/8-14, 3/8-15 la tuerca, el bicono y la rosca A son opuestos a la figura.
 Nos tamanhos 1/4-8, 1/4-10, 3/8-14, 3/8-15 a porca, o cone duplo e a rosca A são do lado oposto ao mostrado na foto.

6450

VALVOLA TUBO - TUBO

TUBE - TUBE VALVE
KUGELHAHN ROHR - ROHR
ROBINET TUBE - TUBE
VÁLVULA TUBO - TUBO
VÁLVULA TUBO - TUBO

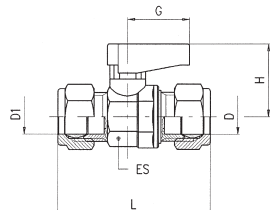

Code	D1	D	DN	ES	L	G	H	Pack.
06450 00 001	6	6	6	14-15	46	19	21	10
06450 00 002	6	8	6	14-15	48	19	21	10
06450 00 003	8	8	6	14-15	48	19	21	10
06450 00 004	10	8	6	14-15	51	19	21	10
06450 00 005	10	10	8	18-19	55	19	22	10
06450 00 006	10	12	8	18-19	56	19	22	10
06450 00 007	12	12	8	18-19	57	19	22	10
06450 00 008	14	10	8	18-19	59.5	19	22	10
06450 00 009	14	12	8	18-19	60.5	19	22	10
06450 00 010	15	10	8	18-19	59.5	19	22	10
06450 00 011	15	12	8	18-19	60.5	19	22	10
06450 00 012	14	14	10	22-23	63	26	30.5	10
06450 00 013	15	14	10	22-23	63	26	30.5	10
06450 00 014	15	15	10	22-23	63	26	30.5	10
06450 00 015	16	14	10	22-23	68	26	30.5	10
06450 00 016	16	15	10	22-23	68	26	30.5	10
06450 00 017	18	14	10	22-23	68	26	30.5	10
06450 00 018	18	15	10	22-23	68	26	30.5	10
06450 00 219	18	16	14	28-30	71	50	33	5
06450 00 220	18	18	14	28-30	71	50	33	5

6460

No Gas

VALVOLA DADO CAPETTATO - MASCHIO CONICO R ISO 7

MILLED NUT - TAPER MALE R ISO 7 VALVE
KUGELHAHN RÄNDELMUTTER - AUSSENGEW. KONISCH R ISO 7
ROBINET ECROU MOLETÉ - FILETAGE R ISO 7
VÁLVULA TUERCA - MACHO CÓNICO R ISO 7
VÁLVULA PORCA RECARTILHADA - ROSCA MACHO CÔNICA R ISO 7

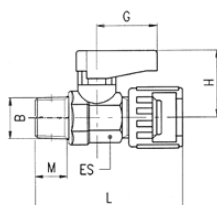

Code	B	DN	ES	M	L	G	H	Pack.
06460 00 001	1/8	6	14-15	7.4	44	19	21	10
06460 00 002	1/4	6	14-15	11	49.5	19	21	10
06460 00 003	3/8	8	18-19	11.4	50	19	21	10

6470

No Gas

VALVOLA DADO CAPETTATO - FEMMINA G ISO 228

MILLED NUT - FEMALE G ISO 228 VALVE
KUGELHAHN RÄNDELMUTTER - INNENGEW. G ISO 228
ROBINET ECROU MOLETÉ - TARAUDAGE G ISO 228
VÁLVULA TUERCA - HEMBRA G ISO 228
VÁLVULA PORCA RECARTILHADA - ROSCA FÊMEA G ISO 228

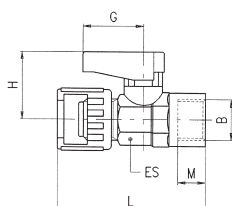

Code	B	DN	ES	M	L	G	H	Pack.
06470 00 001	1/8	6	14-15	7	46	19	21	10
06470 00 002	1/4	6	14-15	8	46	19	21	10

6490

VALVOLA CON PIEDINI D'ANCORAGGIO FEMMINA-FEMMINA

FOOT MOUNTED FEMALE-FEMALE VALVE
 KUGELHAHN MIT INNENGEWINDE UND BEFESTIGUNGSBÜGEL
 ROBINET - TARAUDAGE, PLAQUE DE FIXATION
 VÁLVULA CON PIE DE ANCLAJE HEMBRA-HEMBRA
 VÁLVULA COM PÉS DE FIXAÇÃO ROSCA FÊMEA-FÊMEA

Code	A	B	DN	ES	L	F	M	G	H	H1	P	Pack.
06490 00 002	1/4	1/4	6	14-15	38.5	8	8	19	21	31.5	30	10
06490 00 003	3/8	3/8	8	18-19	44	9	9	19	22	38	32	10

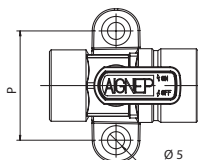
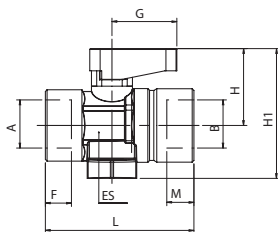

6500

VALVOLA CON PIEDINI D'ANCORAGGIO TUBO-TUBO

FOOT MOUNTED TUBE-TUBE VALVE
 KUGELHAHN MIT BEFESTIGUNGSFLANSCH ROHR-ROHR
 ROBINET TUBE - TUBE, PLAQUE DE FIXATION
 VÁLVULA CON PIE DE ANCLAJE TUBO-TUBO
 VÁLVULA COM PÉS DE FIXAÇÃO TUBO-TUBO

Code	D	D1	DN	ES	L	H	H1	G	P	Pack.
06500 00 001	8	8	6	14-15	50	21	32	19	30	10

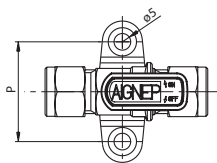
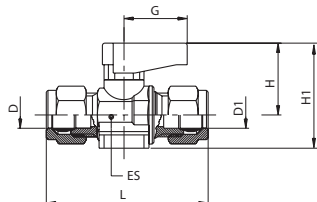

6540

VALVOLA A L MASCHIO CILINDRICO G ISO 228-MASCHIO CONICO R ISO 7

ELBOW PARALLEL MALE G ISO 228-TAPER MALE R ISO 7 VALVE
 WINKELKUGELHAHN AUSSENGEW. ZYLINDRISCH GA ISO 228 - AUSSENGEW. KONISCH R ISO 7
 ROBINET EN EQUERRE, FILETAGE R ISO 7 - FILETAGE G ISO 228
 VÁLVULA A L MACHO CILÍNDRICO G ISO 228 - MACHO CÓNICO R ISO 7
 VÁLVULA EM "L" ROSCA MACHO PARALELA G ISO 228-ROSCA MACHO CÓNICA R ISO 7

Code	A	B	DN	ES	ES1	L	H	H1	G	Pack.
06540 00 001	1/4	1/4	6	14-15	17	48	21	17	19	10

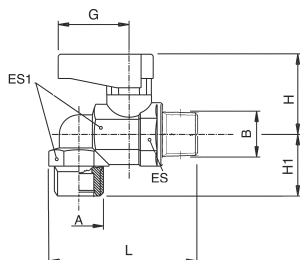

6560

No Gas

VALVOLA CON ATTACCHI TUBO AUTOMATICI

PUSH-IN CONNECTIONS VALVE
 KUGELHAHN MIT STECKANSCHLUSS ROHR - ROHR
 ROBINET, RACCORD INSTANTANÉ
 VÁLVULA PARA TUBO AUTOMÁTICO
 VÁLVULA COM ENGATE RÁPIDO PARA TUBO

Code	Tube	Tube	DN	ES	L	G	H	Pack.
06560 00 001	4	4	3	14-15	44	19	21	10
06560 00 002	6	6	5	14-15	48	19	21	10
06560 00 003	8	8	6	14-15	48	19	21	10
06560 00 075	10	10	8	18-19	58.5	19	22	10
06560 00 076	12	12	10	22-23	66	26	30.5	10

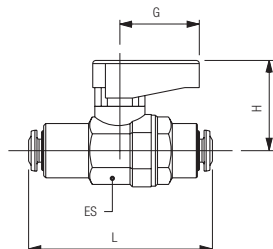

6570

No Gas

VALVOLA MASCHIO CONICO R ISO 7 - ATTACCO TUBO AUTOMATICO

TAPER MALE R ISO 7 - PUSH-FIT CONNECTIONS VALVE
 KUGELHAHN AUSSENGEW. KONISCH R ISO 7 - ROHR STECKANSCHLUSS
 ROBINET TARAUDAGE R ISO 7 - RACCORD INSTANTANÉ
 VÁLVULA A ESFERA MACHO - TUBO AUTOMÁTICO
 VÁLVULA ROSCA MACHO CÔNICA R ISO 7 - ENGATE RÁPIDO PARA TUBO

Code	A	Tube	DN	F	ES	L	C	H	Pack.
06570 00 001	1/8	4	3	8.5	14-15	38.5	19	21	10
06570 00 002	1/8	6	5	8.5	14-15	40	19	21	10
06570 00 004	1/8	8	6	8.5	14-15	41.5	19	21	10
06570 00 003	1/4	6	5	12.5	14-15	38.5	19	21	10
06570 00 005	1/4	8	6	12.5	14-15	45.5	19	22	10

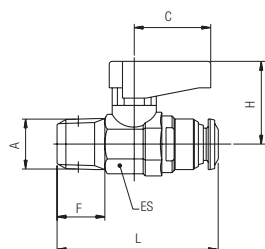

6600

No Gas

VALVOLA CON FORO DI SFIATO FEMMINA G ISO 228

EXHAUST HOLE FEMALE G ISO 228 - FEMALE G ISO 228 VALVE
 KUGELHAHN MIT ENTLÜFTUNGSBOHRUNG INNENGEW. G ISO 228
 ROBINET AVEC PURGE - TARAUDAGE G ISO 228
 VÁLVULA HEMBRA ISO 228 CON ESCAPE ATMÓSFERA
 VÁLVULA COM FURO DE ESCAPE E ROSCA FÊMEA G ISO 228

Code	A	B	DN	ES	F	M	L	G	H	S	Pack.
06600 00 001	1/8	1/8	6	14-15	7	7	35	19	21	2.5	10
06600 00 002	1/4	1/4	6	14-15	8	8	37	19	21	2.5	10
06600 00 003	3/8	3/8	8	18-19	9	9	42	19	22	3	10

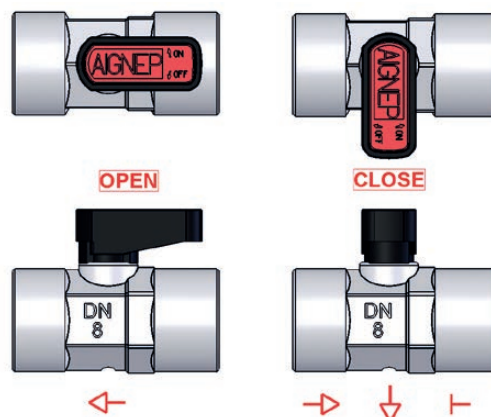
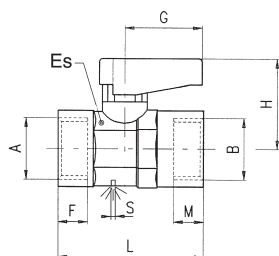

6630

New

RIPARTITORE FEMMINA G ISO 228 A TRE VIE
 THREE-WAY G ISO 228 FEMALE DISTRIBUTOR
 DREIFACH G ISO 228 MUFFENVERTEILER
 DISTRIBUTEUR FEMELLE A TROIS VOIES G ISO 228
 DISTRIBUIDOR DE TRES VIAS G ISO 228 HEMBRA
 DISTRIBUIDOR DE TRÉS VIAS G ISO 228 FÊMEA

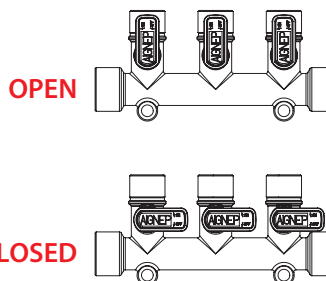
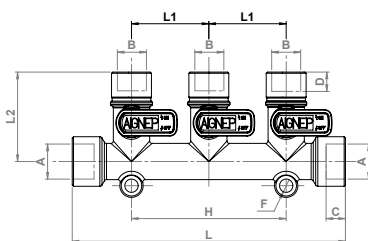

86300

NPTF

VALVOLA FEMMINA NPTF - FEMMINA NPTF
 NPTF FEMALE - NPTF FEMALE VALVE
 KUGELHAHN INNENGEW. NPTF - INNENGEW. NPTF
 ROBINET - TARAUDAGE NPTF
 VÁLVULA HEMBRA NPTF - HEMBRA NPTF
 VÁLVULA ROSCA FÊMEA NPTF - ROSCA FÊMEA NPTF

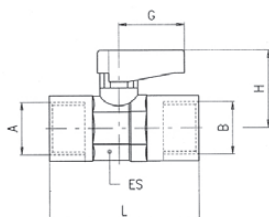

Code	A	B	DN	ES	L	G	H	Pack.
86300 00 001	1/8	1/8	6	14-15	37.5	19	21	10
86300 00 002	1/4	1/4	6	14-15	46	19	21	10
86300 00 003	3/8	3/8	8	18-19	48.5	19	22	10
86300 00 004	1/2	1/2	10	22-23	62	26	30.5	10

86310

NPTF

VALVOLA MASCHIO NPTF - FEMMINA NPTF
 TAPER NPTF MALE - NPTF FEMALE VALVE
 KUGELHAHN AUSSENGEW. NPTF KONISCH - INNENGEW. NPTF
 ROBINET FILETAGE NPTF - TARAUDAGE NPTF
 VÁLVULA MACHO NPTF - HEMBRA NPTF
 VÁLVULA ROSCA MACHO NPTF - ROSCA FÊMEA NPTF

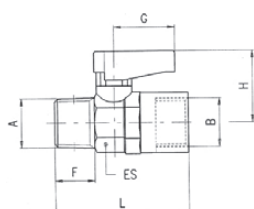

Code	A	B	DN	ES	F	L	G	H	Pack.
86310 00 001	1/8	1/8	6	14-15	8.5	37.5	19	21	10
86310 00 002	1/4	1/4	6	14-15	13	46	19	21	10
86310 00 003	3/8	3/8	8	18-19	13	48.5	19	22	10
86310 00 004	1/2	1/2	10	22-23	17	62	26	30.5	10

SERIE GHINOX

MINIVALVOLE A SFERA IN ACCIAIO INOX AISI 316 L

MINIBALLVALVE IN STAINLESS STEEL AISI 316 L

KUGELHÄHNE AISI 316 L

MINI ROBINET A BOISSEAU SPHERIQUE EN ACIER INOXYDABLE AISI 316L

MINI VÁLVULAS A ESFERA EN ACERO INOX AISI 316L

MINI VÁLVULAS DE ESFERA EM AÇO-INOX AISI 316L



CARATTERISTICHE TECNICHE

TECHNICAL CHARACTERISTICS
 TECHNISCHE ANGABEN
 CARACTÉRISTIQUES TECHNIQUES
 CARACTERÍSTICAS TÉCNICAS
 CARACTERÍSTICAS TÉCNICAS



Norma di Riferimento

Reference standard
 Entspricht der Norm
 Norme de référence
 Normativa de referencia
 Norma de referência

1907/2006 REACH ✓	2011/65/CE RoHS ✓	NSF/ANSI 169 NSF
PED 2014/68/UE	SILICON FREE	M.O.C.A. 1935/2004 CE

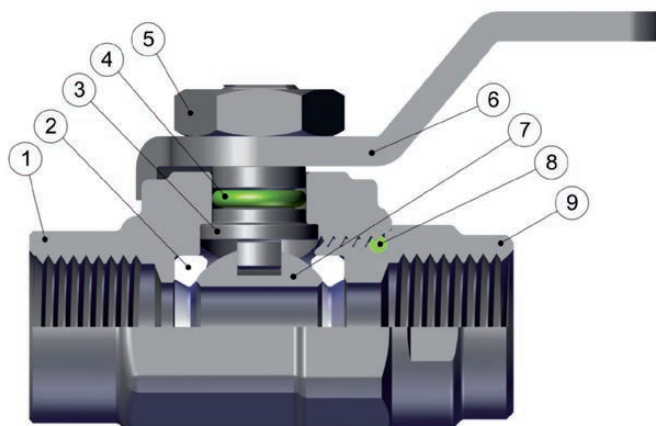

Materiali e Componenti	IT	Component Parts and Materials	GB	Komponenten und Materialien	DE
1 Corpo in acciaio inox AISI 316L		1 Stainless steel AISI 316L Body		1 Körper inox AISI 316L	
2 Guarnizione sede sfera in PTFE		2 PTFE Seats		2 Kugelsitzdichtung PTFE	
3 Albero in acciaio inox AISI316L		3 Stainless steel AISI316L Spindle		3 Spindel inox AISI316L	
4 Guarnizione O-RING in FKM		4 FKM Seal O-RING		4 O-RING FKM	
5 Dado esagonale in acciaio inox AISI316L		5 Stainless steel AISI316L Hex Nut		5 Mutter inox AISI316L	
6 Leva di comando in acciaio inox AISI316L		6 Stainless steel AISI316L Spindle		6 Handgriff inox AISI316L	
7 Sfera in acciaio inox AISI316L		7 Stainless steel AISI316L Ball		7 Kugel inox AISI316L	
8 Guarnizione O-RING in FKM		8 FKM Seal O-RING		8 O-RING FKM	
9 Raccordo in acciaio inox AISI316L		9 Stainless steel AISI316L Fitting		9 Gewindeinsatz inox AISI316L	

Matériaux et Composants	FR	Materiales y Componentes	ES	Materiais e Componentes	PT
1 Corps: acier inoxydable AISI 316L		1 Cuerpo en acero inox AISI 316L		1 Corpo em aço-inox AISI 316L	
2 Joint bille sphérique PTFE		2 Junta sede esfera en PTFE		2 Vedação da sede da esfera em PTFE	
3 Tige: acier inoxydable AISI316L		3 Eje en acero inox AISI316L		3 Eixo em aço-inox AISI316L	
4 Joint tige: FKM		4 Junta tórica en FKM		4 O-ring de Vedação em FKM	
5 Ecrou: acier inoxydable AISI316L		5 Tuerca hexagonal en acero inox AISI316L		5 Porca Sextavada em aço-inox AISI316L	
6 Poignée: acier inoxydable AISI316L		6 Maneta de mando en acero inox AISI316L		6 Haste de comando em aço-inox AISI316L	
7 Bille: acier inoxydable AISI316L		7 Esfera en acero inox AISI316L		7 Esfera em aço-inox AISI316L	
8 Joint tige: FKM		8 Junta tórica en FKM		8 O-ring de Vedação em FKM	
9 Corps: acier inoxydable AISI316L		9 Racor en acero inox AISI316L		9 Conexão em aço-inox AISI316L	



Filettatura Gas cilindrica conforme ISO 228 Classe A. NPTF metrica conforme ANSI B1.20.5	IT	Threads Parallel gas in conformity with ISO 228 Class A. Metric NPTF conformity with ANSI B1.20.5	GB	Gewindearten Zylindrisches Gewinde nach Norm ISO 228 Classe A. Metrisches NPTF nach Norm ANSI B1.20.5	DE
Filetages Filetage cylindrique conforme: ISO 228 Class A. NPTF métrique conforme ANSI B1.20.5	FR	Roscas Gas cilindrica conforme ISO 228 Clase A. NPTF Métrica conforme ANSI B1.20.5	ES	Roscas Gas paralela conforme ISO 228 Classe A. NPTF Métrica conforme ANSI B1.20.5	PT



Fluidi compatibili

Aria compressa / Vuoto / Acqua / Oli

Fluidi per Industria alimentare e chimica compatibili con i componenti.

Fluids

Compressed air / Vacuum / Water / Oils

Fluid for food and chemical industry compatible with components.

Geeignete Medien

Druckluft / Vakuum / Wasser / Oel

Medien für die Lebensmittel- und chemische Industrie, die beständig mit den der Verschraubungen sind.

Fluides compatibles

Air comprimé / Vide / Eau / Huile

Fluides alimentaires et chimiques compatibles avec les matériaux constituants.

Fluidos compatibles

Aire comprimido / Vacío / Agua / Aceite

Fluidos para industria alimentaria y química compatibles con los componentes.

Fluidos compatíveis

Ar comprimido / Vácuo / Água / Óleos

Fluidos para Indústria alimentícia e química compatíveis com os componentes.



Pressioni

Pressures

Druckbereich

Pressions

Pressiones

Pressões

- 0.99 bar (-0.099 MPa)

40 bar (4 MPa)



Temperatura minima

Minimum temperature

Temperatur minimum

Température minimale

Temperatura mínima

Temperatura mínima

- 15 °C

Temperatura massima in continuo

Maximum temperature in continuous

Temperatur maximum kontinuierlich

Température maximale en continu

Temperatura máxima en continuo

Temperatura máxima em contínuo

+ 150 °C

Temperatura massima per breve durata

Maximum temperature for short term

Temperatur maximum für kurzfristig

Pic de température maximale

Temperatura máxima de corta duración

Temperatura máxima em curta duração

+ 180 °C

66300

VALVOLA FEMMINA RP ISO 7 - FEMMINA RP ISO 7

FEMALE RP ISO 7 - FEMALE RP ISO 7 VALVE

KUGELHAHN INNENGEW. RP ISO 7 - INNENGEW. RP ISO 7

ROBINET INOX, TARAUDAGE RP ISO 7

VÁLVULA HEMBRA RP ISO 7 - HEMBRA RP ISO 7

VÁLVULA FÊMEA RP ISO 7 - FÊMEA RP ISO 7



COMPONENT

Code	A	B	DN	CH	F	M	L	G	H	Pack.
66300 00 001	1/8	1/8	5.5	14-15	8.5	8.5	33	28	21.5	2
66300 00 002	1/4	1/4	5.5	16-17	12.5	12.5	43	28	21.5	2

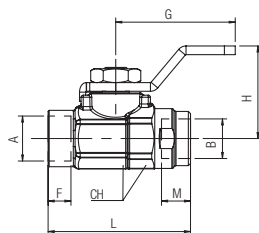

66301

VALVOLA FEMMINA NPTF - FEMMINA NPTF

FEMALE NPTF - FEMALE NPTF VALVE
 KUGELHAHN INNENGEW. NPTF - INNENGEW. NPTF
 ROBINET INOX, TARAUDAGE NPTF
 VÁLVULA HEMBRA NPTF - HEMBRA NPTF
 VÁLVULA FÊMEA NPTF - FÊMEA NPTF

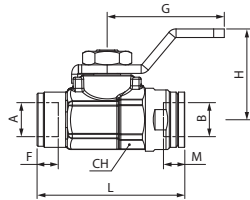

Code	A	B	CH	F	M	L	G	H	Pack.
66301 00 001	1/8	1/8	14-15	9.5	9.5	34.7	27.5	21.5	2
66301 00 002	1/4	1/4	16-17	13.5	13.5	44.7	27.5	21.5	2

66310

VALVOLA MASCHIO CONICO R ISO 7 - FEMMINA RP ISO 7

TAPER MALE R ISO 7 - FEMALE RP ISO 7 VALVE
 KUGELHAHN AUSSENGEW. KONISCH R ISO 7 - INNENGEW. RP ISO 7
 ROBINET INOX, FILETAGE R ISO 7 - TARAUDAGE RP ISO 7
 VÁLVULA MACHO CÓNICO R ISO 7 - HEMBRA RP ISO 7
 VÁLVULA MACHO CÔNICA R ISO7 - FÊMEA RP ISO 7

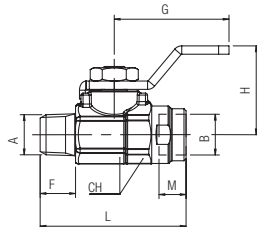

Code	A	B	DN	CH	F	M	L	G	H	Pack.
66310 00 001	1/8	1/8	5.5	14-15	8.5	8.5	35	28	21.5	2
66310 00 002	1/4	1/4	5.5	16-17	12.5	12.5	44.5	28	21.5	2

66311

VALVOLA MASCHIO CONICO NPTF - FEMMINA NPTF

TAPER MALE NPTF - FEMALE NPTF VALVE
 KUGELHAHN AUSSENGEW. KONISCH NPTF - INNENGEW. NPTF
 ROBINET INOX, FILETAGE NPTF - TARAUDAGE NPTF
 VÁLVULA MACHO CÓNICO NPTF - HEMBRA NPTF
 VÁLVULA MACHO CÔNICA NPTF - FÊMEA RP NPTF

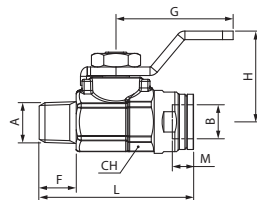

Code	A	B	CH	F	M	L	G	H	Pack.
66311 00 001	1/8	1/8	14-15	9	9.5	35	27.5	21.5	2
66311 00 002	1/4	1/4	16-17	13	13.5	45.7	27.5	21.5	2

66560

VALVOLA CON ATTACCHI TUBO AUTOMATICI

PUSH-IN CONNECTIONS VALVE

KUGELHAHN MIT STECKANSCHLUSS ROHR - ROHR

ROBINET, RACCORD INSTANTANÉ

VÁLVULA PARA TUBO AUTOMÁTICO

VÁLVULA COM ENGATE RÁPIDO PARA TUBO



Code	Tube	Tube	DN	CH	L	G	H	Pack.
66560 00 002	6	6	5	14-15	45	28	21.5	2
66560 00 003	8	8	5.5	16-17	52	28	21.5	2

min

max



Pressure

20 bar

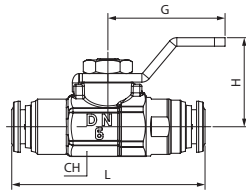

66570

VALVOLA MASCHIO CONICO R ISO 7 - ATTACCO TUBO AUTOMATICO

TAPER MALE R ISO 7 - PUSH-FIT CONNECTIONS VALVE

KUGELHAHN AUSSENGEW. KONISCH R ISO 7 - ROHR STECKANSCHLUSS

ROBINET TARAUDAGE R ISO 7 - RACCORD INSTANTANÉ

VÁLVULA A ESFERA MACHO - TUBO AUTOMÁTICO

VÁLVULA ROSCA MACHO CÔNICA R ISO 7 - ENGATE RÁPIDO PARA TUBO



Code	Tube	A	DN	F	CH	L	G	H	Pack.
66570 00 002	6	1/8	5	8.5	14-15	41	28	21.5	2
66570 00 003	6	1/4	5	12.5	16-17	45	28	21.5	2
66570 00 004	8	1/8	5.5	8.5	14-15	43	28	21.5	2
66570 00 005	8	1/4	5.5	12.5	16-17	48	28	21.5	2

min

max



Pressure

20 bar

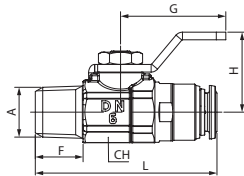

VALVOLE A SFERA - CW510L

CW510L - BALL VALVES
 KUGELHÄHNE - CW510L
 ROBINET A BOISSEAU SPHERIQUE - CW510L
 VÁLVULAS A ESFERA - CW510L
 VÁLVULAS DE ESFERA - CW510L



CARATTERISTICHE TECNICHE

TECHNICAL CHARACTERISTICS
 TECHNISCHE ANGABEN
 CARACTÉRISTIQUES TECHNIQUES
 CARACTERÍSTICAS TÉCNICAS
 CARACTERÍSTICAS TÉCNICAS

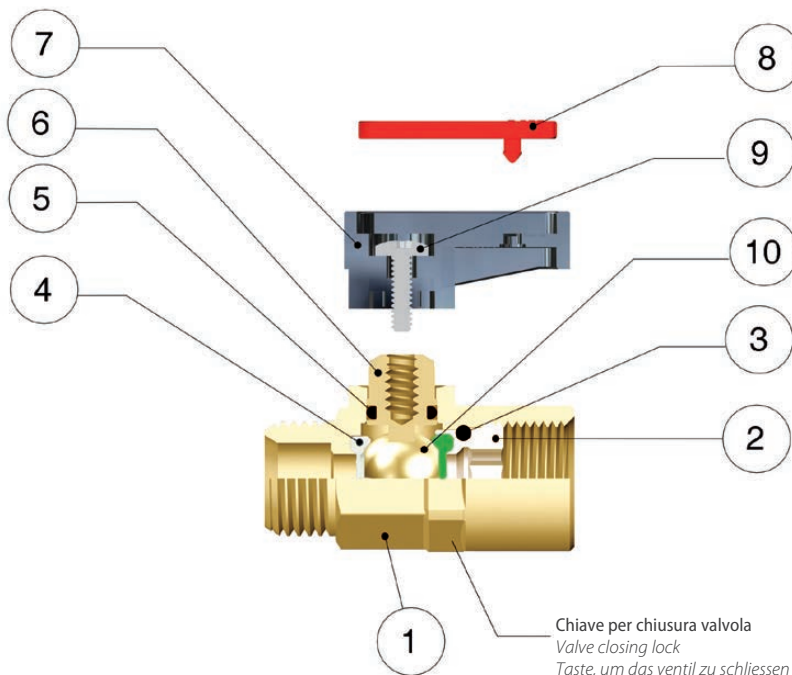

Chiave per chiusura valvola
 Valve closing lock
 Taste, um das Ventil zu schliessen
 Clé pour vanne de fermeture
 Llave para el cierre de la válvula
 A chave para o fecho da válvula



Norma di Riferimento

Reference Standard
 Entspricht Der Norm
 Conforme à La Norme
 Normativa de Referencia
 Norma de Referència

1907/2006 REACH ✓	2011/65/CE RoHS ✓	M.O.C.A. 1935/2004 CE
PED 2014/68/UE	SILICON FREE	

DIAGRAMMA PRESSIONE - TEMPERATURA

PRESSURE - TEMPERATURE RATINGS DIAGRAM
 DRUCK - TEMPERATUR DIAGRAMM
 DIAGRAMME PRESSION - TEMPÉRATURE
 DIAGRAMA PRESIÓN-TEMPERATURA
 DIAGRAMA DE PRESSÃO-TEMPERATURA

PTFE + FKM



Temperature

Temperatures
 Temperatur
 Températures
 Temperaturas
 Temperaturas

FKM
 - 15 °C
 + 130 °C

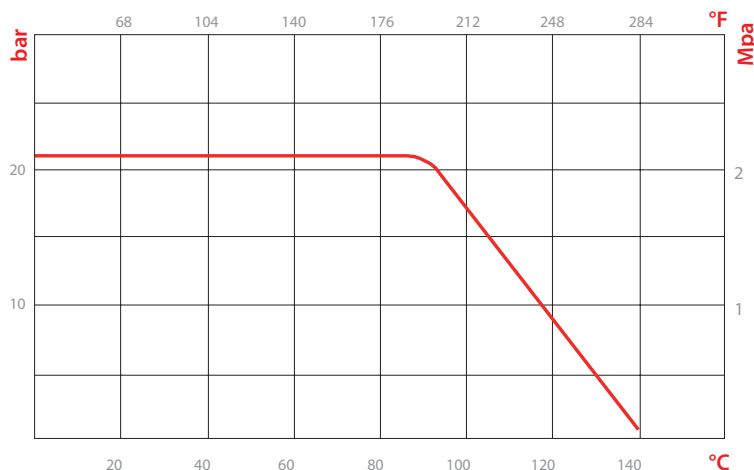



Pressioni

Pressures

Druckbereich

Pressions

Presiones

Pressões

-0.99 bar (-0.099 MPa)

20 bar (2 MPa)



Fluidi compatibili

Aria compressa / Vuoto / Acqua / Alimenti

Fluids

Compressed air / Vacuum / Water / Food

Geeignete Medien

Druckluft / Vakuum / Wasser / Lebensmittel

Fluides compatibles

Air comprimé / Vide / Eau / Boissons

Fluidos compatibles

Aire comprimido / Vacío / Agua / Alimentos

Fluidos compatíveis

Ar comprimido / Vácuo / Água / Alimentos

Materiali e Componenti	IT	Component Parts and Materials	GB	Komponenten und Materialien	DE
1 Corpo in Ottone CW510L		1 CW510L brass body		1 Körper Messing CW510L	
2 Ghiera o raccordo in Ottone CW510L		2 CW510L Brass Fitting		2 Gewindeinsatz Messing CW510L	
3 Guarnizione O-ring FKM Alimentare		3 O-Ring seal in FKM Food		3 O-Ringdichtung FKM Lebensmittelkonform	
4 Guarnizione sede sfera in PTFE		4 PTFE Seats		4 Kugelsitzdichtung PTFE	
5 Guarnizione O-ring FKM Alimentare		5 O-Ring seal in FKM Food		5 O-Ringdichtung FKM lebensmittelkonform	
6 Albero in Ottone CW510L		6 CW510L Brass Spindle		6 Spindel Messing CW510L	
7 Maniglietta in PA66 Caricato vetro		7 PA66 Glass reinforced Handle		7 Handgriff PA66 Glasfaser verstärkt	
8 Piastrina in Resina Acetalica		8 Acetalic resin Plate		8 Griffplatte Acetal	
9 Vite in acciaio		9 Steel Screw		9 Schraube Stahl	
10 Sfera in Ottone CW510L		10 CW510L Nickel-plated Brass Ball		10 Kugel Messing CW510L	

Matériaux et Composants	FR	Materiales y Componentes	ES	Materiais e Componentes	PT
1 Corps en laiton CW510L		1 Cuerpo en latón CW510L		1 Corpo em latão CW510L	
2 Ecrou de blocage: laiton CW510L		2 Racor en latón CW510L		2 Conexões em Latão CW510L	
3 Joint O-ring FKM qualité alimentaire		3 Junta tórica en FKM alimentario		3 Vedação o-ring em FKM alimentício	
4 Joint bille sphérique: PTFE		4 Junta sede esfera en PTFE		4 Vedação da sede da esfera em PTFE	
5 Joint O-ring FKM qualité alimentaire		5 Junta tórica en FKM alimentario		5 Vedação o-ring em FKM alimentício	
6 Tige: laiton CW510L		6 Eje en latón CW510L		6 Eixo em Latão CW510L	
7 Poignée en PA66 chargé en fibre de verre		7 Maneta en PA66 con fibra de vidrio		7 Manopla em PA66 e fibra de vidro	
8 Plaquette de poignée: résine acétal		8 Plaqueta en PA6		8 Piaqueta de Resina Acetálica	
9 Vis: acier		9 Tornillo en acero		9 Parafuso em aço	
10 Bille: laiton CW510L		10 Esfera en latón CW510L		10 Esfera em Latão CW510L	



Filettatura	IT	Threads	GB	Gewindearten	DE
Gas conforme ISO 7.1, BS 21, DIN 2999		Gas in conformity with ISO7.1, BS 21, DIN 2999.		Gewinde nach Norm ISO 7.1, BS 21, DIN 2999.	

Filetages	FR	Roscas	ES	Roscas	PT
Filetage conforme: ISO7.1, BS 21, DIN 2999.		Gas conforme ISO 7.1, BS 21, DIN 2999		Gas conforme ISO 7.1, BS 21, DIN 2999.	

6315

VALVOLA MASCHIO CONICO R ISO 7 - FEMMINA RP ISO 7

TAPER MALE R ISO 7 - FEMALE RP ISO 7 VALVE

KUGELHAHN AUSSENGEW. KONISCH R ISO 7 - INNENGEW. RP ISO 7

ROBINET FILETAGE R ISO 7 - TARAUDAGE RP ISO 7

VÁLVULA MACHO CÓNICO R ISO 7 - HEMBRA RP ISO 7

VÁLVULA ROSCA MACHO CÓNICA R ISO 7 - ROSCA FÊMEA RP ISO 7



Code	A	B	DN	ES	F	M	L	G	H	Pack.
06315 000 01 CW	1/8	1/8	6	14-15	7.4	7.4	36	19	21	25
06315 000 03 CW	1/4	1/4	6	14-15	11	11	43	19	21	25

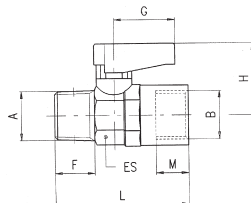

MINIVALVOLA A SFERA A 2-3 VIE

2-3 WAYS MINIBALLVALVE
DREIWEGKUGELHAHN
MINI ROBINET A BOISSEAU SPHERIQUE 2-3 VOIES
MINIVÁLVULA DE ESFERA 2-3 VÍAS
MINI-VÁLVULA DE ESFERA DE 2-3 VIAS



CARATTERISTICHE TECNICHE

TECHNICAL CHARACTERISTICS
TECHNISCHE ANGABEN
CARACTÉRISTIQUES TECHNIQUES
CARACTERÍSTICAS TÉCNICAS
CARACTERÍSTICAS TÉCNICAS



Norma di Riferimento

- Reference standard
- Entspricht der Norm
- Norme de référence
- Normativa de referencia
- Norma de referência

1907/2006
REACH ✓

2011/65/CE
RoHS ✓

PED
2014/68/UE

**SILICON
FREE**

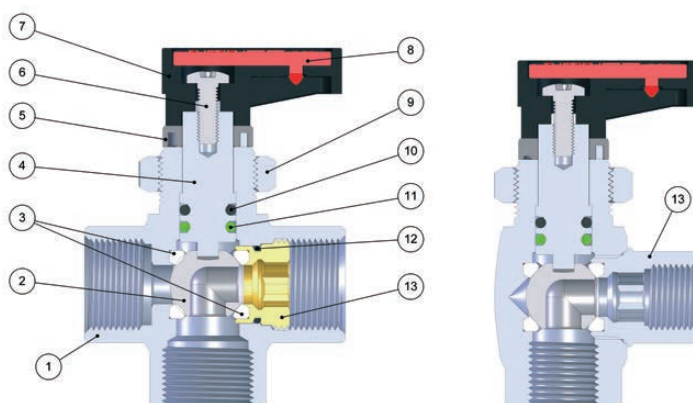

*** FKM A RICHIESTA**
IF REQUESTED FKM
FKM AUF ANFRAGE
FKM SUR DEMANDE
FKM BAJO PEDIDO
FKM SOB ENCOMENDA

Materiali e Componenti	IT	Component Parts and Materials	GB	Komponenten und Materialien	DE
1 Corpo in Ottone cromato		1 Chrome Nickel-plated Brass Body		1 Körper Messing verchromt	
2 Sfera in Ottone cromato		2 Chrome Nickel-plated Brass Ball		2 Kugel Messing verchromt	
3 Guarnizione sede sfera in PTFE		3 PTFE Seat		3 Kugelsitzdichtung PTFE	
4 Albero in Ottone cromato		4 Chrome Nickel-plated Brass Spindle		4 Spindel Messing verchromt	
5 Fermo Maniglia		5 Stop Handle		5 Anschlag	
6 Vite in acciaio		6 Steel Screw		6 Schraube Stahl	
7 Maniglietta in PA66 Caricato vetro		7 PA66 Glass reinforced Handle		7 Handgriff PA66 Glasfaser verstärkt	
8 Piastrina in Resina Acetalica		8 Acetalic resin Plate		8 Griffplatte Acetal	
9 Ghiera per passaparete		9 Bulkhead nut		9 Mutter Messing Vernickelt	
10 Guarnizione O-RING in NBR		10 NBR Seal O-RING		10 O-RING in NBR	
11 Guarnizione O-RING in FKM		11 FKM Seal O-RING		11 O-RING in FKM	
12 Guarnizione O-RING in NBR		12 NBR Seal O-RING		12 O-RING in NBR	
13 Ghiera o raccordo in Ottone		13 Brass Fitting		13 Körper Messing verchromt	

Matériaux et Composants	FR	Materiales y Componentes	ES	Materiais e Componentes	PT
1 Corps: laiton chromé		1 Cuerpo en latón cromado		1 Corpo em latão cromado	
2 Bille: laiton chromé		2 Esfera en latón cromado		2 Esfera em latão cromado	
3 Joint bille sphérique: PTFE		3 Junta de asiento esfera en PTFE		3 Vedação sede da esfera em PTFE	
4 Tige: laiton chromé		4 Eje en latón cromado		4 Árvore em latão cromado	
5 Butée		5 Base Maneta		5 Fixador de manopla	
6 Vis: acier		6 Tornillo en acero		6 Parafuso em aço	
7 Poignée: PA66 chargé en fibre de verre		7 Maneta en PA66 fibra de vidrio		7 Manopla em PA66	
8 Plaquette de poignée: résine acétal		8 Plaqueta en resina acetálica		8 Plaqueta em resina acetálica	
9 Ecrou: Laiton nickelé		9 Tuerca para pasatabiques		9 Porca de fixação passa-muro	
10 Joint torique NBR		10 Junta O-RING en NBR		10 Vedação O-RING in NBR	
11 Joint torique FKM		11 Junta O-RING en FKM		11 Vedação O-RING em FKM	
12 Joint torique NBR		12 Junta O-RING en NBR		12 Vedação O-RING em NBR	
13 Corps: laiton chromé		13 Tuerca o racor en latón		13 Proca e conexão em Latão	



Pressioni

Pressures

Druckbereich

Pressions

Presiones

Pressões

-0.99 (-0.099 MPa)

20 bar (2 MPa)



Temperature

Temperatures

Temperatur

Températures

Temperaturas

Temperaturas

- 20 °C

+ 80 °C

FKM

- 15 °C

+ 130 °C



Fluidi compatibili

Aria compressa / Acqua / Oli

Fluids

Compressed air / Water / Oils

Geeignete Medien

Druckluft / Wasser / Oel

Fluides compatibles

Aire comprimé / Eau / Huile

Fluidos compatibles

Aire comprimido / Agua / Aceite

Fluidos compatíveis

Ar comprimido / Água / Óleos



Filettatura

Gas conforme ISO 7.1, BS 21, DIN 2999
Gas cilíndrica conforme ISO 228 Classe A.

IT

Threads

Gas in conformity with ISO 7.1, BS 21, DIN 2999.
Parallel gas in conformity with ISO 228 Class A.

GB

Gewindearten

Gewinde nach Norm ISO 7.1, BS 21, DIN 2999.
Zylindrisches Gewinde nach Norm ISO 228 Classe A.

DE

Filetages

Filetage conforme: ISO 7.1, BS 21, DIN 2999.
Filetage cylíndrique conforme: ISO 228 Classe A.

FR

Roscas

Gas conforme ISO 7.1, BS 21, DIN 2999
Gas cilíndrica conforme ISO 228 Clase A.

ES

Roscas

Gas conforme ISO 7.1, BS 21, DIN 2999.
Gas paralela conforme ISO 228 Classe A.

PT

6700

No Gas

VALVOLA TRE VIE A "L" FEMMINA G ISO 228

3 WAYS VALVE "L" FEMALE G ISO 228

DREIWEGEKUGELHAHN INNENGEW "L" G ISO 228

ROBINET A 3 VOIES TARAUDAGE À "L" FEMELLE G ISO 228

VÁLVULA DE 3 VIAS HEMBRA DE "L" G ISO 228

VÁLVULA DE TRÊS VIAS ROSCA FÊMEA A "L" G ISO 228

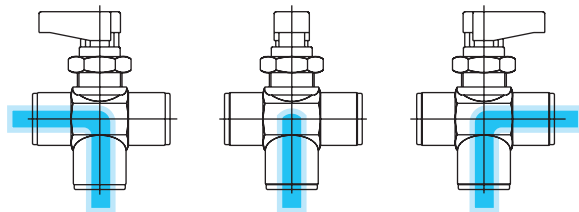
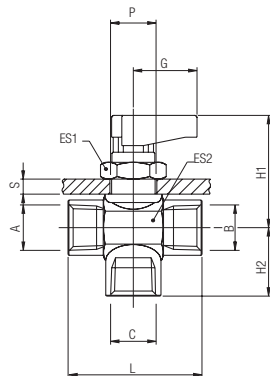

Code	A	B	C	DN	ES1	ES2	L	G	H1	H2	S max	P	Pack.
06700 00 001	1/8	1/8	1/8	5	17	17	35	19	33.5	15.5	4.5	14.5	10
06700 00 002	1/4	1/4	1/4	5	17	17	37	19	33.5	17.5	4.5	14.5	10
06700 00 003	3/8	3/8	3/8	7	17	21	42	19	35	19.5	4.5	14.5	10

6710

No Gas

VALVOLA TRE VIE A "T" FEMMINA G ISO 228

3 WAYS VALVE "T" FEMALE G ISO 228
 DREIWEGEKUGELHAHN INNENGEW "T": G ISO 228
 ROBINET A 3 VOIES TARAUDAGE À "T" FEMELLE G ISO 228
 VÁLVULA DE 3 VÍAS HEMBRA DE "T" G ISO 228
 VÁLVULA DE TRÊS VIAS ROSCA FÊMEA A "T" G ISO 228

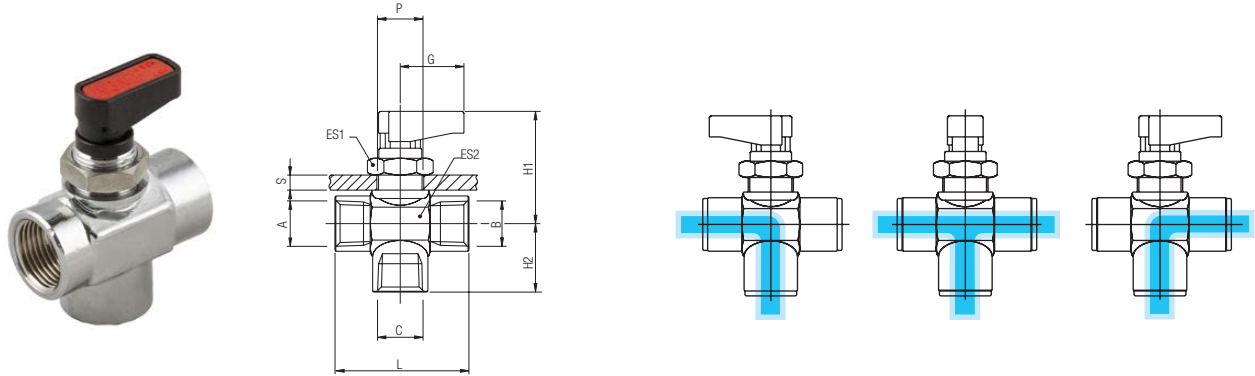

Code	A	B	C	DN	ES1	ES2	L	G	H1	H2	S max	P	Pack.
06710 00 001	1/8	1/8	1/8	5	17	17	35	19	33.5	15.5	4.5	14.5	10
06710 00 002	1/4	1/4	1/4	5	17	17	37	19	33.5	17.5	4.5	14.5	10
06710 00 003	3/8	3/8	3/8	7	17	21	42	19	35	19.5	4.5	14.5	10

6720

No Gas

VALVOLA A "L" FEMMINA G ISO 228

VALVE "L" FEMALE G ISO 228
 WINKELKUGELHAHN INNENGEW G ISO 228
 ROBINET EQUERRE, FILETAGE G ISO 228
 VÁLVULA A "L" HEMBRA G ISO 228
 VÁLVULA EM "L" ROSCA FÊME G ISO 228

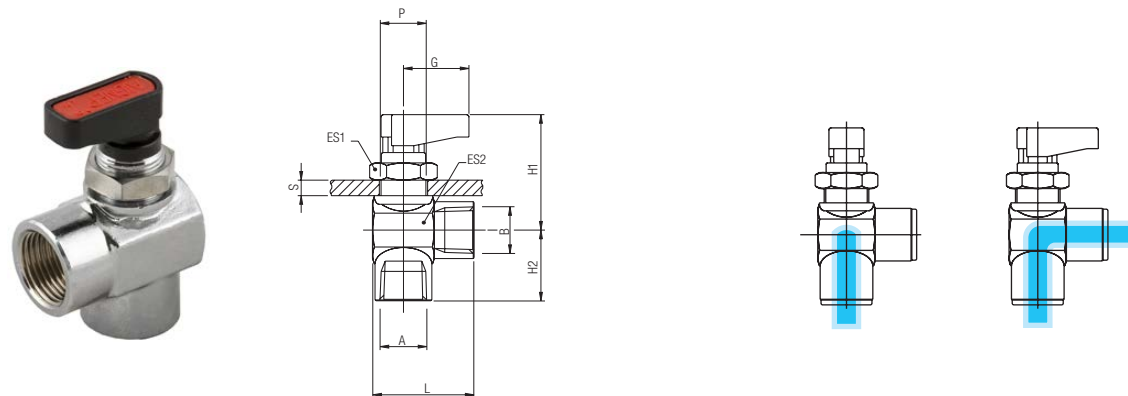

Code	A	B	DN	ES1	ES2	L	G	H1	H2	S max	P	Pack.
06720 00 001	1/8	1/8	5	17	17	28.5	19	33.5	15.5	4.5	14.5	10
06720 00 002	1/4	1/4	5	17	17	28.5	19	33.5	17.5	4.5	14.5	10
06720 00 003	3/8	3/8	7	17	21	31	19	35	19.5	4.5	14.5	10

6730

No Gas

VALVOLA A "T" FEMMINA G ISO 228

VALVE "T" FEMALE G ISO 228

DREIWEGEKUGELHAHN INNENGEW "T" G ISO 228

ROBINET À "T" FILETAGE FEMELLE G ISO 228

VÁLVULA A "T" HEMBRA G ISO 228

VÁLVULA EM "T" ROSCA FÊME G ISO 228

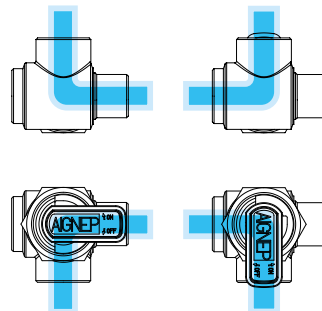
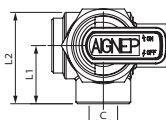
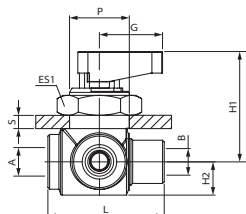

Code	A	B	C	DN	ES1	L	L1	L2	G	H1	H2	S max	P	Pack.
06730 00 001	1/8	1/8	1/8	5	22	35	17.5	27.5	19	33.5	10	4.5	18.5	10
06730 00 002	1/4	1/4	1/4	5	22	38.5	17.5	27.5	19	33.5	11.5	4.5	18.5	10

ACCESSORI

ACCESSORIES
ZUBEHÖR
ACCESSOIRES
ACCESORIOS
ACESÓRIOS

6900

MANIGLIA CORTA
SHORT HANDLE
HANDGRIFF KURZ
POIGNÉE COURT
MANETA CORTA
MANOPLA CURTA

New

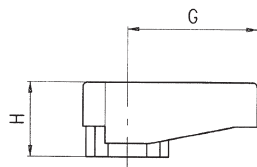

Code	Type	G	H	Pack.
06900 A0 30 00 00	A	19	11	20
06900 B0 30 00 00	B	26	15	20
Metallo - Metal - Metall - Métal - Metal - Metal				
06900 A0 80 00 NE	A	19	11	20

A = Per valvole da 1/8 - 1/4 - 3/8.

For valves of 1/8 - 1/4 - 3/8.
Für Kugelhähne mit 1/8 - 1/4 - 3/8.
Pour vannes 1/8 - 1/4 - 3/8.
Para válvulas de 1/8 - 1/4 - 3/8.
Para válvulas de 1/8 - 1/4 - 3/8.

B = Per valvole da 1/2 - 3/4.

For valves of 1/2 - 3/4.
Für Kugelhähne mit 1/2 - 3/4.
Pour vannes of 1/2 - 3/4.
Para válvulas de 1/2 - 3/4.
Para válvulas de 1/2 - 3/4.

Maniglia CORTA standard per valvola da 1/8-1/4-3/8-1/2.

Standard SHORT Handle for Valve 1/8-1/4-3/8-1/2.

Handgriff KURZ Standard für 1/8-1/4-3/8-1/2.

Poignée COURTE en standard pour 1/8-1/4-3/8-1/2.

Maneta CORTA estándar para válvula de 1/8-1/4-3/8-1/2.

Manopla CURTA standard para válvula de 1/8-1/4-3/8-1/2.

6910

MANIGLIA LUNGA
LONG HANDLE
HANDGRIFF LANG
POIGNÉE RALLONGÉE
MANETA LARGA
MANOPLA LONGA

New

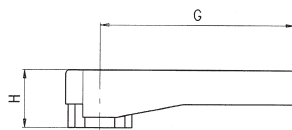

Code	Type	G	H	Pack.
06910 A0 30 00 00	A	35	11	20
06910 B0 30 00 00	B	50	15	20
Metallo - Metal - Metall - Métal - Metal - Metal				
06910 B0 80 00 NE	B	50	15	20

A = Per valvole da 1/8 - 1/4 - 3/8.

For valves of 1/8 - 1/4 - 3/8.
Für Kugelhähne mit 1/8 - 1/4 - 3/8.
Pour vannes 1/8 - 1/4 - 3/8.
Para válvulas de 1/8 - 1/4 - 3/8.
Para válvulas de 1/8 - 1/4 - 3/8.

B = Per valvole da 1/2 - 3/4.

For valves of 1/2 - 3/4.
Für Kugelhähne mit 1/2 - 3/4.
Pour vannes of 1/2 - 3/4.
Para válvulas de 1/2 - 3/4.
Para válvulas de 1/2 - 3/4.

Maniglia LUNGA standard per valvola da 3/4.

standard LONG Handle for Valve 3/4.

Handgriff LANG Standard für 3/4.

Poignée RALLONGÉE en standard pour 3/4.

Maneta LARGA estándar para válvula de 3/4.

Manopla LONGA standard para válvula de 3/4.

6915

PROLUNGA ALBERO DI COMANDO (CON MANIGLIA LUNGA, VITE)
SPINDLE EXTENSION (WITH LONG HANDLE, SCREW)
VERLÄNGERTE SCHALTWELLE (MIT LANGEM GRIFF UND SCHRAUBE)
EXTENSION AVEC POIGNÉE LONGUE ET VIS
PROLONGACIÓN EJE DE MANDO (CON MANETA LARGA, TORNILLO Y PLAQUETA)
PROLONGAMENTO DE EIXODE COMANDO (COM MANOPLA LONGA, PAREFUSOS)

Code	Type	Valve size	L	Pack.
06915 00 001	A	1/8	58	10
		1/4	58	
		3/8	59	
06915 00 002	B	1/2	68	10
		3/4	70	

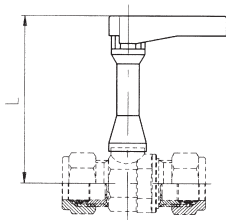

6920

PIASTRINA COLORATA

COLOURED PLATE
HANDGRIFF FARBEN
PLAQUETTE DE COULEURS
PLAQUETA COLOREADA
PLAQUETA COLORIDA



Code	Type	Color	Pack.
06920 A0 30 00 RO	A	Red	10
06920 B0 30 00 RO	B	Red	10
06920 A0 30 00 GI	A	Yellow	10
06920 B0 30 00 GI	B	Yellow	10
06920 A0 30 00 BL	A	Blue	10
06920 B0 30 00 BL	B	Blue	10
06920 A0 30 00 VE	A	Green	10
06920 B0 30 00 VE	B	Green	10
06920 A0 30 00 BN	A	White	10
06920 B0 30 00 BN	B	White	10

6680

DADO

NUT
ÜBERWURFMUTTER
ECROU
TUERCA
PORCA

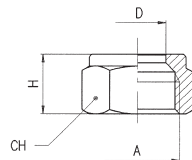

Code	D	A	H	CH	Pack.
06680 00 01 BS CT	6	1/8	11	12	100
06680 00 01 BJ CT	8	1/4	12	15	100
06680 00 01 CG CT	10	3/8	13	19	100
06680 00 01 CL CT	12	3/8	14	19	100
06680 00 01 DB CT	14	1/2	15	24	100
06680 00 01 CP CT	15	1/2	15	24	100
06680 00 01 CS CT	16	3/4	17	30	100
06680 00 01 CX CT	18	3/4	17	30	100

10740

OGIVA OTTONE

BRASS OLIVE
KLEMMRING MESSING
BAGUE LAITON
BICONO LATÓN
BUCHA DE LATÃO

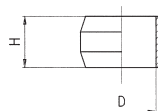

Code	D	H	Pack.
10740 00 02 X4 00	6	6.5	50
10740 00 02 X7 00	8	6.5	50
10740 00 02 X9 00	10	7.5	50
10740 00 02 Y1 00	12	8	50
10740 00 02 Y4 00	15	9	20
10740 00 02 Y7 00	18	10	20

10741

OGIVA OTTONE

BRASS OLIVE
KLEMMRING MESSING
BAGUE LAITON
BICONO LATÓN
BUCHA DE LATÃO

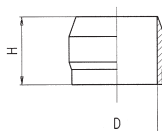

Code	D	H	Pack.
10741 00 01 Y3 00	14	12	50
10741 00 01 Y5 00	16	13.5	50

10760

OGIVA PTFE

PTFE OLIVE
KLEMMRING PTFE
BAGUE PTFE
BICONO PTFE
BUCHA DE PTFE

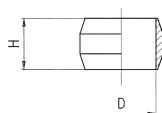

Code	D	H	Pack.
10760 00 28 X4 00	6	6.5	50
10760 00 28 X7 00	8	6.5	50
10760 00 28 Y1 00	12	8	50
10760 00 28 Y4 00	15	9	50
10760 00 28 Y7 00	18	10	50

10761

OGIVA PTFE

PTFE OLIVE
KLEMMRING PTFE
BAGUE PTFE
BICONO PTFE
BUCHA DE PTFE

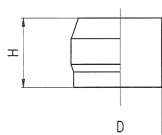

Code	D	H	Pack.
10761 00 28 Y3 00	14	12	50
10761 00 28 Y5 00	16	13.5	50

MINIVALVOLE A SFERA

MINIBALL VALVES
MINI-KUGELHÄHNE
ROBINET MINI
MINI VÁLVULAS A ESFERA
MINI VÁLVULAS DE ESFERA



CARATTERISTICHE TECNICHE

TECHNICAL CHARACTERISTICS
TECHNISCHE ANGABEN
CARACTÉRISTIQUES TECHNIQUES
CARACTERÍSTICAS TÉCNICAS
CARACTERÍSTICAS TÉCNICAS



Norma di Riferimento

Reference standard

Entspricht der Norm

Norme de référence

Normativa de referencia

Norma de referência

1907/2006

REACH

2011/65/CE

RoHS

PED

2014/68/UE

SILICON

FREE

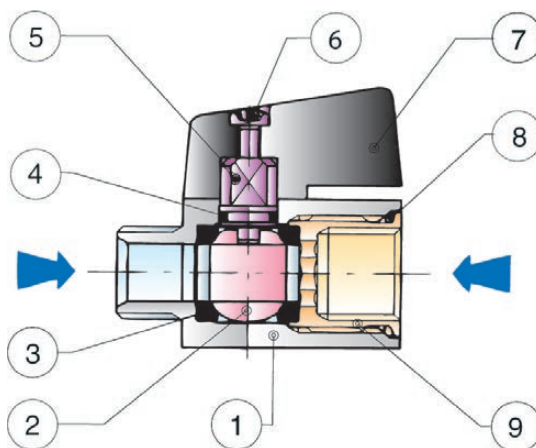

Materiali e Componenti	IT	Component Parts and Materials	GB	Komponenten und Materialien	DE
1 Corpo in Ottone nichelato		1 Nickel-plated Brass Body		1 Körper Messing vernickelt	
2 Sfera in Ottone nichelato		2 Nickel-plated Brass Ball		2 Kugel Messing vernickelt	
3 Guarnizione sede sfera in PTFE		3 PTFE Seats		3 Kugelsitzdichtung PTFE	
4 Guarnizione O-RING in NBR		4 NBR Seal O-RING		4 O-Ring NBR	
5 Albero in Ottone nichelato		5 Nickel-plated Brass Spindle		5 Spindel Messing vernickelt	
6 Vite in acciaio		6 Steel Screw		6 Schraube Stahl	
7 Maniglia in PA66 Caricato vetro - 3/4 alluminio		7 PA66 Glass reinforced Handle -3/4 Aluminium		7 Handgriff PA66 Glasfaser verstärkt - 3/4 Aluminium	
8 Guarnizione O-RING in NBR		8 NBR Seal O-RING		8 O-Ring NBR	
9 Ghiera o raccordo in Ottone nichelato		9 Nickel-plated Brass Fitting		9 Gewindeinsatz Messing vernickelt	

Matériaux et Composants	FR	Materiales y Componentes	ES	Materiais e Componentes	PT
1 Corps: laiton nickelé		1 Cuerpo en latón niquelado		1 Corpo em Latão Niquelado	
2 Bille: laiton nickelé		2 Esfera en latón niquelado		2 Esfera em Latão Niquelado	
3 Joint bille sphérique: PTFE		3 Junta sede esfera en PTFE		3 Vedação da sede da esfera em PTFE	
4 Joint tige: NBR		4 Junta tórica O-RING en NBR		4 Vedação O-RING em NBR	
5 Tige: laiton nickelé		5 Eje en latón niquelado		5 Eixo em Latão Niquelado	
6 Vis: acier		6 Tornillo en acero		6 Parafuso em aço	
7 Poignée: PA66 chargé en fibre de verre - 3/4 Aluminium		7 Maneta en PA66 con fibra de vidrio - 3/4 aluminio		7 Manopla em PA66 com Fibra de Vidro - 3/4 Alumínio	
8 Joint tige: NBR		8 Junta tórica O-RING en NBR		8 Vedação O-RING em NBR	
9 Ecrou de blocage: laiton nickelé		9 Racor en latón niquelado		9 Conexão em Latão Niquelado	



Pressioni

Pressures

Druckbereich

Pressions

Presiones

Pressões

-0.99 (-0.099 MPa)

10 bar (1 MPa)



Temperature

Temperatures

Temperatur

Températures

Temperaturas

Temperaturas

- 15 °C

+ 110 °C

Con Acqua

With Water

Mit Wasser

Avec de l'Eau

Con Agua

Com Água

0 °C

+ 90 °C



Fluidi compatibili

Aria compressa / Acqua / Oli / Vuoto

Fluids

Compressed air / Water / Oils / Vacuum

Geeignete Medien

Druckluft / Wasser / Verschiedene Oele / Vakuum

Fluides compatibles

Air comprimé / Eau / Huiles / Vide

Fluidos compatibles

Aire comprimido / Agua / Aceite / Vacío

Fluidos compatíveis

Ar comprimido / Água / Óleos / Vazio



Filettatura Cilindrica conforme ISO 228 Classe A.	IT Threads Parallel in conformity with ISO 228 Class A.	GB Gewindearten Zylindrisches Gewinde nach Norm ISO 228 Classe A.	DE
Filetages Cylindrique conforme: ISO 228 Class A.	FR Roscas Cilíndrica conforme ISO 228 Classe A.	ES Roscas Paralela conforme ISO 228 Classe A.	PT

6065

No Gas

VALVOLA A SFERA MINI FEMMINA G ISO 228 - FEMMINA G ISO 228

MINI BALL VALVE FEMALE G ISO 228 - FEMALE G ISO 228
 MINI-KUGELHAHN INNENGEW. G ISO 228 - INNENGEW. G ISO 228
 MINI ROBINET TARAUDAGE G ISO 228
 VÁLVULA A ESFERA MINI HEMBRA G ISO 228 - HEMBRA G ISO 228
 MINI-VÁLVULA DE ESFERA FÊMEA G ISO 228 - FÊMEA G ISO 228

Code	A	DN	B	C	CH	Pack.
06065 00 001	1/8	6	39	38	21	10
06065 00 002	1/4	8	40	38	21	10
06065 00 003	3/8	8	42	38	21	10
06065 00 004	1/2	10	48	42	25	10
06065 00 005	3/4	12	54	47	30	10

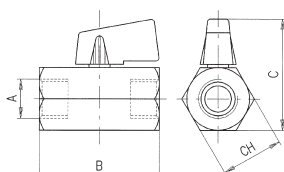

6066

No Gas

VALVOLA A SFERA MINI MASCHIO G ISO 228 - FEMMINA G ISO 228

MINI BALL VALVE MALE G ISO 228 - FEMALE G ISO 228
 MINI-KUGELHAHN AUSSENGEW. G ISO 228 - INNENGEW. G ISO 228
 MINI ROBINET FILETAGE - TARAUDAGE G ISO 228
 VÁLVULA A ESFERA MINI MACHO G ISO 228 - HEMBRA G ISO 228
 MINI-VÁLVULA DE ESFERA ROSCA MACHO G ISO 228 - ROSCA FÊMEA G ISO 228

Code	A	DN	B	C	CH	Pack.
06066 00 001	1/8	6	39	38	21	10
06066 00 002	1/4	8	39	38	21	10
06066 00 003	3/8	8	40	38	21	10
06066 00 004	1/2	10	46	42	25	10
06066 00 005	3/4	12	51	47	30	10

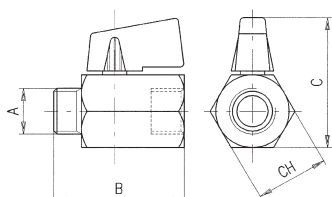

New

MINIVALVOLE A SFERA IN ACCIAIO INOX AISI 316

MINIBALLVALVE IN STAINLESS STEEL AISI 316

KUGELHÄHNE AISI 316

MINI ROBINET A BOISSEAU SPHERIQUE EN ACIER INOXYDABLE AISI 316

MINI VÁLVULAS A ESFERA EN ACERO INOX AISI 316

MINI VÁLVULAS DE ESFERA EM AÇO-INOX AISI 316



CARATTERISTICHE TECNICHE

TECHNICAL CHARACTERISTICS

TECHNISCHE ANGABEN

CARACTÉRISTIQUES TECHNIQUES

CARACTERÍSTICAS TÉCNICAS

CARACTERÍSTICAS TÉCNICAS



Norma di Riferimento

Reference standard

Entspricht der Norm

Norme de référence

Normativa de referencia

Norma de referência

1907/2006

REACH ✓

2011/65/CE

RoHS ✓

PED
2014/68/UE

SILICON
FREE

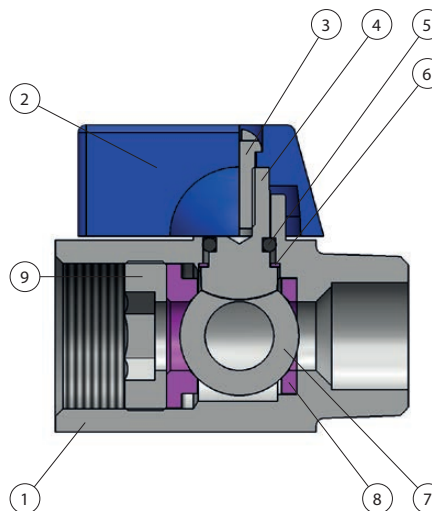

Materiali e Componenti

- 1 Corpo in acciaio INOX AISI 316
- 2 Leva di comando in Alluminio verniciato
- 3 Vite in acciaio INOX AISI 316
- 4 Albero in Acciaio INOX AISI 316
- 5 Guarnizione O-RING in FKM
- 6 Guarnizione in PTFE
- 7 Sfera in acciaio INOX AISI 316
- 8 Guarnizione sede sfera in PTFE
- 9 Ghiera o raccordo in Acciaio INOX AISI 316

IT

Component Parts and Materials

- 1 AISI 316 stainless steel body
- 2 Painted aluminium control lever
- 3 AISI 316 stainless steel screw
- 4 AISI 316 stainless steel shaft
- 5 FKM O-RING gasket
- 6 PTFE gasket
- 7 AISI 316 stainless steel ball
- 8 PTFE ball seat gasket
- 9 AISI 316 stainless steel ring nut or fitting

GB

Komponenten und Materialien

- 1 Gehäuse aus rostfreiem Stahl AISI 316
- 2 Steuerhebel aus lackiertem Aluminium
- 3 Schraube aus rostfreiem Stahl AISI 316
- 4 Welle aus rostfreiem Stahl AISI 316
- 5 FKM O-RING Dichtung
- 6 PTFE-Dichtung
- 7 Kugel aus rostfreiem Stahl AISI 316
- 8 PTFE-Kugelsitzdichtung
- 9 Ringmutter oder Fitting aus Edelstahl AISI 316

DE

Matériaux et Composants

- 1 Corps en acier inoxydable AISI 316
- 2 Levier de commande en aluminium peint
- 3 Vis en acier inoxydable AISI 316
- 4 Arbre en acier inoxydable AISI 316
- 5 Joint FKM O-RING
- 6 Joint en PTFE
- 7 Bille en acier inoxydable AISI 316
- 8 Joint de siège de bille en PTFE
- 9 Écrou ou raccord à bague en acier inoxydable AISI 316

FR

Materiales y Componentes

- 1 Cuerpo de acero inoxidable AISI 316
- 2 Palanca de control de aluminio pintado
- 3 Tornillo de acero inoxidable AISI 316
- 4 Eje de acero inoxidable AISI 316
- 5 Junta tórica FKM
- 6 Junta de PTFE
- 7 Bola de acero inoxidable AISI 316
- 8 Junta del asiento de la bola de PTFE
- 9 Tuerca anular o racor de acero inoxidable AISI 316

ES

Materiais e Componentes

- 1 Corpo em aço inoxidável AISI 316
- 2 Alavanca de controle em alumínio pintado
- 3 Parafuso em aço inoxidável AISI 316
- 4 Eixo de aço inoxidável AISI 316
- 5 Anel de vedação FKM O-RING
- 6 Junta de PTFE
- 7 Esfera de aço inoxidável AISI 316
- 8 Junta da sede da esfera em PTFE
- 9 Porca ou conexão do anel em aço inoxidável AISI 316

PT



Temperature

Temperatures
Temperatur
Températures
Temperaturas
Temperaturas

- 20 °C
+ 80 °C



Pressioni

Pressures
Druckbereich
Pressions
Presiones
Pressões

0 (0 MPa)
63 bar (6.3 MPa)



Fluidi compatibili

Aria compressa / Acqua / Oli / Gas inerti

Fluids

Compressed air / Water / Oils / Inert gases

Geeignete Medien

Druckluft / Wasser / Verschiedene Oele / Inerte Gase

Fluides compatibles

Air comprimé / Eau / Huiles / Gaz inerti

Fluidos compatibles

Aire comprimido / Agua / Aceite / Gas inerti

Fluidos compatíveis

Ar comprimido / Água / Óleos / Gases inertes



Diagramma pressione-temperatura

Curve caratteristiche della pressione-temperatura delle valvole a sfera art. 6065X - 6066X

IT

Pressure-temperature ratings diagram

Pressure-temperature characteristic curves of ball valves art. 6065X - 6066X

GB

Druck-temperatur diagramm

Druck-Temperatur-Kennlinien von Kugelhähnen Art. 6065X - 6066X

DE

Diagramme pression / température

Courbes caractéristiques pression-température des robinets à tournant sphérique art. 6065X - 6066X

FR

Diagrama presión-temperatura

Curvas características presión-temperatura de las válvulas de bola art.6065X - 6066X

ES

Diagrama pressão-temperatura

Curvas características de pressão-temperatura das válvulas de esfera art. 6065X - 6066X

PT

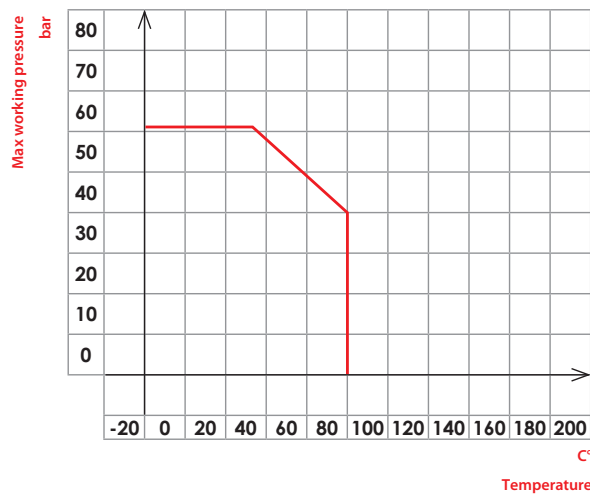

Filettatura

Gas conica conforme ISO 7.1, BS 21, DIN 2999.
Gas cilindrica conforme ISO 228 Classe A.

IT

Threads

Tapered gas in conformity with ISO 7.1, BS 21, DIN 2999.
Parallel gas in conformity with ISO 228 Class A.

GB

Gewindearten

Konisches Gewinde nach Norm ISO 7.1, BS 21, DIN 2999.
Zylindrisches Gewinde nach Norm ISO 228 Classe A.

DE

Filetages

Filetage conique conforme: ISO 7.1, BS 21, DIN 2999.
Filetage cylindrique conforme: ISO 228 Class A.

FR

Roscas

Gas cónica conforme ISO 7.1, BS 21, DIN 2999.
Gas cilíndrica conforme ISO 228 Clase A.

ES

Roscas

Gas cônica conforme ISO 7.1, BS 21, DIN 2999.
Gas paralela conforme ISO 228 Classe A.

PT

6065X

New No Gas

VALVOLA A SFERA MINI FEMMINA G ISO 228 - FEMMINA G ISO 228

MINI BALL VALVE FEMALE G ISO 228 - FEMALE G ISO 228
 MINI-KUGELHAHN INNENGEW. G ISO 228 - INNENGEW. G ISO 228
 MINI-ROBINET TARAUDAGE G ISO 228
 VÁLVULA A ESFERA MINI HEMBRA G ISO 228 - HEMBRA G ISO 228
 MINI-VÁLVULA DE ESFERA FÊMEA G ISO 228 - FÊMEA G ISO 228

Code	A	DN	B	C	G	CH	Pack.
06065 X0 002	1/4	7	42	37	23	22	2
06065 X0 003	3/8	7	42	37	23	22	2
06065 X0 004	1/2	9.2	46	40.5	23	25	2

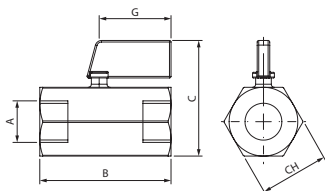

6066X

New No Gas

VALVOLA A SFERA MINI MASCHIO CONICO R ISO 7 - FEMMINA G ISO 228

MINI BALL VALVE CONICAL MALE R ISO 7 - FEMALE G ISO 228
 MINI-KUGELHAHN AUSSENGEW. KONISCH MÄNNLICH R ISO 7 - INNENGEW. G ISO 228
 MINI-VANNE A BILLE MALE CONIQUE R ISO 7 - FEMELLE G ISO 228
 VÁLVULA A ESFERA MINI MACHO CÓNICA R ISO 7 - HEMBRA G ISO 228
 MINI-VÁLVULA DE ESFERA ROSCA MACHO CÓNICO R ISO 7 - ROSCA FÊMEA G ISO 228

Code	A	DN	B	C	G	CH	Pack.
06066 X0 002	1/4	7	40	37.5	23	22	2
06066 X0 003	3/8	7	40	37.5	23	22	2
06066 X0 004	1/2	9.2	45.6	40.8	23	25	2

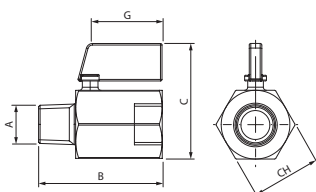

VALVOLE A SFERA

BALL VALVES
KUGELHÄHNE
ROBINET A BOISSEAU SPHERIQUE
VÁLVULAS A ESFERA
VÁLVULAS DE ESFERA



CARATTERISTICHE TECNICHE

TECHNICAL CHARACTERISTICS
TECHNISCHE ANGABEN
CARACTÉRISTIQUES TECHNIQUES
CARACTERÍSTICAS TÉCNICAS
CARACTERÍSTICAS TÉCNICAS



Norma di Riferimento

Reference standard

Entspricht der Norm

Norme de référence

Normativa de referencia

Norma de referência

1907/2006
REACH ✓

2011/65/CE
RoHS ✓

PED
2014/68/UE

SILICON
FREE

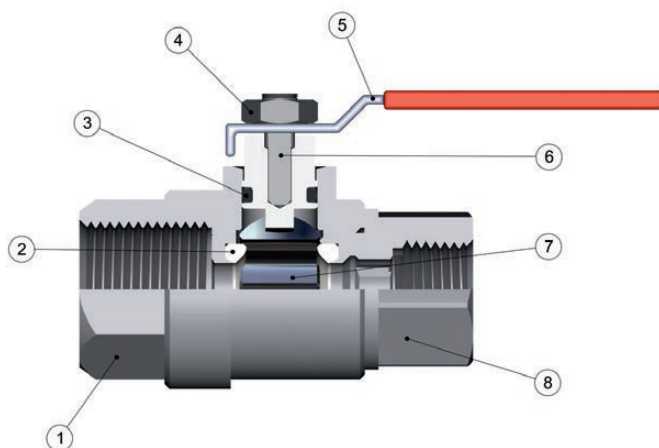

IT	Component Parts and Materials	GB	Komponenten und Materialien	DE
1	Corpo in ottone nichelato	1	Körper Messing vernickelt	1
2	Guarnizione sede sfera in PTFE	2	Kugelsitzdichtung PTFE	2
3	Guarnizione asta: 6068 FKM 6067/6069 EPDM	3	Spindeldichtung: 6068 FKM 6067/6069 EPDM	3
4	Dado per leva in Acciaio	4	Hebelmutter Stahl	4
5	Leva di manovra in acciaio plastificato	5	Bedienhebel Stahl plastifiziert	5
6	Asta di manovra in ottone nichelato	6	Bedienspindel Messing vernickelt	6
7	Sfera in ottone cromato	7	Kugel Messing verchromt	7
8	Raccordo in Ottone Nichelato	8	Einschraubkörper Messing vernickelt	8

FR	Materiales y Componentes	ES	Materiais e Componentes	PT
1	Corps: laiton nickelé	1	Corpo em Latão Niquelado	1
2	Joint de forme: PTFE	2	Vedação da sede da esfera em PTFE	2
3	Joint de tige: 6068 FKM 6067/6069 EPDM	3	Vedação da haste: 6068 FKM 6067/6069 EPDM	3
4	Ecrou de blocage: acier	4	Dado per leva em Aço	4
5	Poignée plastifiée: acier	5	Manopla de manobra em aço plastificado	5
6	Tige: laiton nickelé	6	Haste de manobra em Latão Niquelado	6
7	Bille: laiton chromé	7	Esfera em Latão cromado	7
8	Raccord: laiton nickelé	8	Conexões em Latão Niquelado	8



Diagramma pressione-temperatura	IT	Pressure-temperature ratings diagram	GB	Druck-temperatur diagramm	DE
Curve caratteristiche della pressione-temperatura delle valvole a sfera art. 6067 - 6068 - 6069		Pressure-temperature characteristic curves of ball valves art. 6067 - 6068 - 6069		Druck-Temperatur-Kennlinien von Kugelhähnen Art. 6067 - 6068 - 6069	

Diagramme pression / température	FR	Diagrama presión-temperatura	ES	Diagrama pressão-temperatura	PT
Courbes caractéristiques pression-température des robinets à tournant sphérique art. 6067 - 6068 - 6069		Curvas características presión-temperatura de las válvulas de bola art. 6067 - 6068 - 6069		Curvas características de pressão-temperatura das válvulas de esfera art. 6067 - 6068 - 6069	

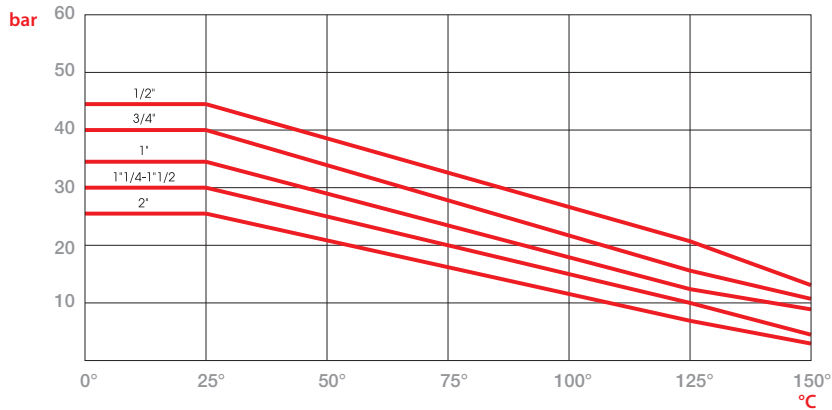

6067

VALVOLA A SFERA, FEMMINA G ISO 228 - FEMMINA G ISO 228

BALL VALVE, FEMALE G ISO 228 - FEMALE G ISO 228
 KUGELHAHN, INNENGEW. G ISO 228 - INNENGEW. G ISO 228
 ROBINET TARAUDAGE G ISO 228
 VÁLVULA A ESFERA HEMBRA G ISO 228 - HEMBRA G ISO 228
 VÁLVULA DE ESFERA, FÊMEA G ISO 228 - FÊMEA G ISO 228

Code	A	DN	CH	L	G	H	Pack.
06067 00 001	1/2	15	25	46	88	47.5	10
06067 00 002	3/4	20	31	56.5	88	51	10
06067 00 003	1"	25	38	65.5	105	63	5
06067 00 004	1 1/4	32	48	77	105	68.5	2
06067 00 005	1 1/2	40	54	88.5	134	84.5	1
06067 00 006	2"	50	67	101.5	134	92.5	1

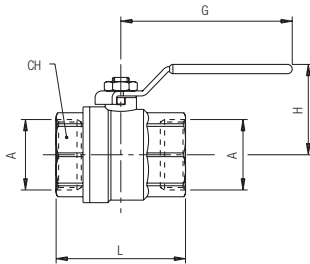

IT	GB	DE
<ul style="list-style-type: none"> Fluidi compatibili: Aria compressa / Acqua Fino al DN20: Valgono le condizioni riportate nel diagramma Dal DN25 al DN50: Pressione Max: 18 bar 	<ul style="list-style-type: none"> Fluids: Compressed air / Water DN 15 and 20: Use Diagram condition From DN25 to DN50: Max Pressure: 18 bar 	<ul style="list-style-type: none"> Geeignete Medien: Druckluft / Wasser Bis zu DN20: Verwenden Sie die Angaben im Diagramm Von DN25 bis DN50: Max. Druck: 18 bar

FR	ES	PT
<ul style="list-style-type: none"> Fluides compatibles: Air comprimé / Eau DN 15 et 20: Pour définir la pression maximale, consulter le diagramme De DN25 jusqu'à DN50: pression maximum: 18 bar 	<ul style="list-style-type: none"> Fluidos compatibles: Aire comprimido / Agua Hasta el DN20: Ver los valores representados en el diagrama Del DN25 al DN50, Presión Máx: 18 bar 	<ul style="list-style-type: none"> Fluidos compatíveis: Ar comprimido / Água DN15 e DN20: Verifique as condições informadas no diagrama De DN25 a DN50, Pressão Máx: 18 bar

6068

VALVOLA A SFERA PER GAS, FEMMINA RP ISO7 - FEMMINA RP ISO7

GAS BALL VALVE, FEMALE RP ISO7 - FEMALE RP ISO7
 KUGELHAHN FÜR GAS, INNENGEW. RP ISO7 - INNENGEW. RP ISO7
 ROBINET POUR GAZ - TARAUDAGE RP ISO7
 VÁLVULA A ESFERA PARA GAS HEMBRA RP ISO7 - HEMBRA RP ISO7
 VÁLVULA DE ESFERA PARA GÁS, ROSCA FÊMEA RP ISO7 - ROSCA FÊMEA RP ISO7

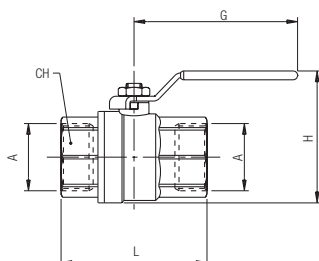

Code	A	DN	CH	L	G	H	Pack.
06068 00 007	1/4	10	22	46	88	50	10
06068 00 008	3/8	12	22	46	88	50	10
06068 00 001	1/2	15	26	59	88	58	10
06068 00 002	3/4	20	32	67.3	88	65	10
06068 00 003	1"	25	40	77.5	105	74	5
06068 00 004	1"1/4	32	49	92	105	85	2
06068 00 005	1"1/2	40	55	101.5	134	100	1
06068 00 006	2"	50	68	122.5	134	116.5	1



IT	GB	DE
Dal DN15 al DN50: 1° e 2° Famiglia di gas a media pressione e 3° famiglia di gas a bassa pressione. Omologato BS EN 331:2015 fino a pressione Max: 5 bar.	From DN 15 to 50: Fluids: 1st and 2nd gas family to medium pressure 3th gas family to low pressure. Omologated BS EN 331:2015 to Max pressure: 5bar.	Von DN15 bis DN50: 1. und 2. Familie von Gasen für Mitteldruck und 3. Familie von Gasen für Niederdruck. Zugelassen nach BS EN 331:2015 bis zu einem max. Druck von 5 bar.

FR	ES	PT
De DN15 jusqu'à DN50: 1ère et 2ème famille des gaz moyenne pression et 3ème famille des gaz basse pression. Homologué BS EN 331:2015 jusqu'à une pression de: 5bar.	Del DN15 al DN50: 1ª y 2ª Familia de gases a media presión y 3ª familia de gas a baja presión. Homologado BS EN 331:2015 hasta presión Máx: 5 bar.	De DN15 a DN50: 1º e 2º Família de gás a média pressão e 3º família de gás a baixa pressão. Homologadas BS EN 331:2015 até a pressão Máx: 5 bar.

6069

VALVOLA A SFERA MASCHIO G ISO 228 - FEMMINA G ISO 228

BALL VALVE MALE G ISO 228 - FEMALE G ISO 228
 KUGELHAHN, AUSSENGEW. G ISO 228 - INNENGEW. G ISO 228
 ROBINET, FILETAGE G ISO 228 - TARAUDAGE G ISO 228
 VÁLVULA A ESFERA MACHO G ISO 228 - HEMBRA G ISO 228
 VÁLVULA DE ESFERA ROSCA MACHO G ISO 228 - ROSCA FÊMEA G ISO 228

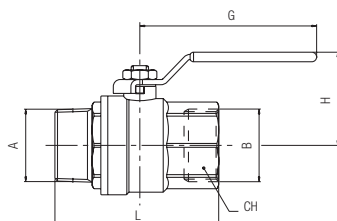

Code	A	B	DN	CH	L	G	H	Pack.
06069 00 001	1/2	1/2	15	25	56	88	47.5	10
06069 00 002	3/4	3/4	20	31	63.5	88	51	10
06069 00 003	1"	1"	25	38	74	105	63	5
06069 00 004	1"1/4	1"1/4	32	48	85	105	68.5	2
06069 00 005	1"1/2	1"1/2	40	54	100	134	84.5	1
06069 00 006	2"	2"	50	67	121.5	134	92.5	1



IT	GB	DE
<ul style="list-style-type: none"> Fluidi compatibili: Aria compressa / Acqua Fino al DN20: Valgono le condizioni riportate nel diagramma Dal DN25 al DN50: Pressione Max: 18 bar 	<ul style="list-style-type: none"> Fluids: Compressed air / Water DN 15 and 20: Use Diagram condition From DN25 to DN50: Max Pressure: 18 bar 	<ul style="list-style-type: none"> Geeignete Medien: Druckluft / Wasser Bis zu DN20: Verwenden Sie die Angaben im Diagramm Von DN25 bis DN50: Max. Druck: 18 bar

FR	ES	PT
<ul style="list-style-type: none"> Fluides compatibles: Air comprimé / Eau DN 15 et 20: Pour définir la pression maximale, consulter le diagramme De DN25 jusqu'à DN50: pression maximum: 18 bar 	<ul style="list-style-type: none"> Fluidos compatibles: Aire comprimido / Agua Hasta el DN20: Ver los valores representados en el diagrama Del DN25 al DN50, Presión Máx: 18 bar 	<ul style="list-style-type: none"> Fluidos compatíveis: Ar comprimido / Água DN15 e DN20: Verifique as condições informadas no diagrama De DN25 a DN50, Pressão Máx: 18 bar

VALVOLE A SFERA A 3 VIE PASSAGGIO A "T" E A "L"

3 WAYS BALL VALVES FEMALE - "T" & "L"
 3-WEGE KUGELHAHN MIT "L" UND "T" BOHRUNG
 ROBINET A 3 VOIES PASSAGE EN "T" ET EN "L"
 VÁLVULA DE ESFERA A 3 VÍAS PASO A "T" Y A "L"
 VÁLVULA ESFERA 3 VIAS COM PASSAGEM "T" E "L"



CARATTERISTICHE TECNICHE

TECHNICAL CHARACTERISTICS
 TECHNISCHE ANGABEN
 CARACTÉRISTIQUES TECHNIQUES
 CARACTERÍSTICAS TÉCNICAS
 CARACTERÍSTICAS TÉCNICAS



Norma di Riferimento

Reference standard

Entspricht der Norm

Norme de référence

Normativa de referencia

Norma de referência

1907/2006

REACH ✓

2011/65/CE

RoHS ✓

PED
2014/68/UE

SILICON
FREE

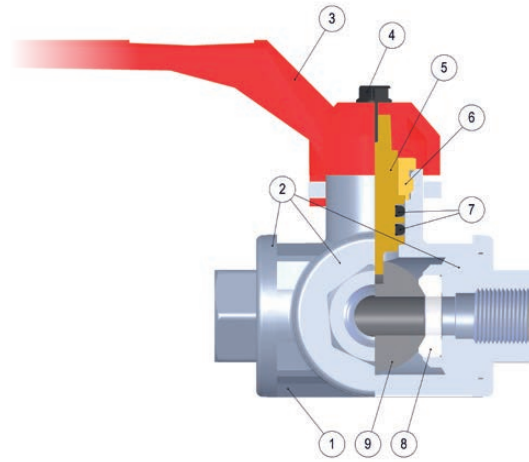

Materiali e Componenti	IT	Component Parts and Materials	GB	Komponenten und Materialien	DE
1 Corpo in ottone nichelato		1 Nickel-plated brass body		1 Körper Messing vernickelt	
2 Raccordi in ottone nichelato		2 Nickel-plated brass adaptors		2 Anschlüsse Messing vernickelt	
3 Leva in alluminio EN-AB46100		3 Aluminum handle EN-AB46100		3 Griff Aluminium EN-AB46100	
4 Vite acciaio zincato		4 Zinc plated screw		4 Schraube Stahl verzinkt	
5 Asta di manovra in ottone giallo		5 Handling needle in yellow brass		5 Spindel Messing	
6 Premiguarnizione in ottone giallo		6 Seal locker in yellow brass		6 Hülse Messing	
7 Guarnizione asta FKM		7 Needle seal FKM		7 Dichtung Spindel FKM	
8 Guarnizione sede sfera in PTFE		8 Ball seat seal PTFE		8 Kugelsitzdichtung PTFE	
9 Sfera in ottone cromato		9 Chrome-plated brass ball		9 Kugel Messing verchromt	

Matériaux et Composants	FR	Materiales y Componentes	ES	Materiais e Componentes	PT
1 Corps en laiton nickelé		1 Cuerpo en latón niquelado		1 Corpo em latão niquelado	
2 Raccordement en laiton nickelé		2 Racores en latón niquelado		2 Conexões em latão niquelado	
3 Poignée en aluminium EN-AB46100		3 Leva en aluminio EN-AB46100		3 Alavanca em alumínio EM-AB46100	
4 Vis en acier zing ué		4 Tornillo en acero zincado		4 Parafusos em aço zincado	
5 Tige en laiton		5 Eje de maniobra en latón natural		5 Haste de manobra em latão amarelo	
6 Axe de tige en laiton		6 Sujeta junta en latón natural		6 Prensa-vedações em latão amarelo	
7 Joint de tige en FKM		7 Junta eje en FKM		7 Vedações da haste em FKM	
8 Joint de forme en PTFE		8 Junta sede esfera en PTFE		8 Vedações da base da esfera em PTFE	
9 Bille laiton chromé		9 Esfera en latón cromado		9 Esfera em latão cromado	



Temperature
 Temperatures
 Temperatur
 Températures
 Temperaturas
 Temperaturas

- 10 °C
 + 120 °C



Fluidi compatibili
 Aria compressa / Vuoto / Acqua / Oli

Fluids
 Compressed air / Vacuum / Water / Oils

Geeignete Medien
 Druckluft / Vakuum / Wasser / Oel

Fluides compatibles
 Air comprimé / Vide / Eau / Huile

Fluidos compatibles
 Aire comprimido / Vacío / Agua / Aceite

Fluidos compatíveis
 Ar comprimido / Vácuo / Água / Óleos



Diagramma Pressione - Temperatura
 Pressure - Temperature ratings diagram
 Druck - Temperatur diagramm
 Diagramme Pression - Température
 Diagrama Presión - Temperatura
 Diagrama de Pressão - Temperatura

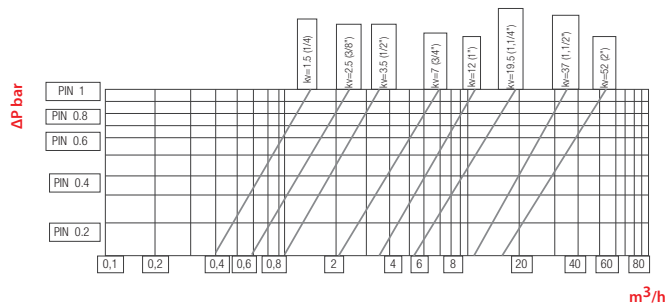
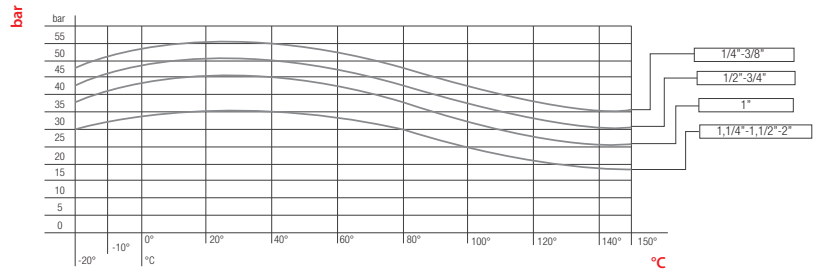

Attenzione

La presente valvola deve essere impiegata alle condizioni esposte in questa scheda, e dalla misura 1 - 1/4" e superiori, non deve essere utilizzata per fluidi pericolosi quali: esplosivi, infiammabili, tossici e comburenti.

IT

Attention

This valve must be used at the above described conditions. From size 1-1/4" and bigger, do not use with dangerous fluids: explosives, inflammables, inflammables, toxic and combusive.

GB

Achtung

Dieses Ventil muss unter den in diesem Anhang angegebenen Bedingungen verwendet werden. Die Abmessungen 1 1/4" und grösser, dürfen nicht für gefährliche Flüssigkeiten verwendet werden, wie zum Beispiel: hochexplosive, entzündliche, giftige und oxidierende.

DE

Attention

Ces robinets doivent être utilisée dans le tableau ci dessus. A partir de 1 - 1/4 " ils ne doivent pas être utilisés pour des fluides dangereux (explosifs, produits inflammables, produits toxiques...).

FR

Atención

La presente válvula debe ser utilizada a las condiciones expuestas en esta tabla, y desde la medida 1 - 1/4" y superior, no debe ser utilizada para fluidos peligrosos tales como: explosivos, inflamables, tóxicos y oxidantes.

ES

Atenção

A presente válvula deve ser aplicada às condições expostas neste tabela, e nas medidas 1-1/4" e superiores não deve ser utilizada para fluidos perigosos, tais como: explosivos, inflamáveis, tóxicos e comburentes.

PT



Filettatura

Gas cilindrica conforme ISO 228 Classe A.

IT

Threads

Parallel gas in conformity with ISO 228 Class A.

GB

Gewindearten

Zylindrisches Gewinde nach Norm ISO 228 Classe A.

DE

Filetages

Filetage cylindrique conforme: ISO 228 Class A.

FR

Roscas

Gas cilíndrica conforme ISO 228 Clase A.

ES

Roscas

Gas paralela conforme ISO 228 Classe A.

PT

6074

VALVOLA 3 VIE A L FEMMINA G ISO 228

3 WAYS BALL VALVE "L" FEMALE G ISO 228

3-WEGE WINKEL-KUGELHAHN INNENGEW. G ISO 228

ROBINET 3 VOIES EN L TARAUDEE G ISO 228

VÁLVULA 3 VIAS A L HEMBRA G ISO 228

VÁLVULA 3 VIAS EM "L" ROSCA FÊMEA G ISO 228

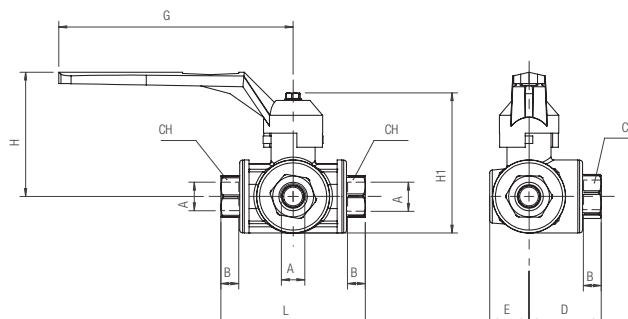

Code	A	B	H	D	L	G	H1	E	CH	DN	PN 20°/40 °C	Pack.
06074 V0 001	1/4	18	65	38.5	77	125	75	22	22	10	55	2
06074 V0 002	3/8	18	65	38.5	77	125	75	22	22	12	55	2
06074 V0 003	1/2	18	65	38.5	77	125	75	22	27	14	50	2
06074 V0 004	3/4	22	83	46	92	145	91	25	34	18	50	2
06074 V0 005	1"	23	96	52	104	170	105	30	41	23	45	2
06074 V0 006	1"1/4	26	102	59	118	170	115	34	50	29	35	1
06074 V0 007	1"1/2	30	109	69	138	170	128	40	57	36	35	1
06074 V0 008	2"	35	139	81	162	260	165	48	70	45	35	1

Funzionamento valvola a L	IT	L valve - Function	GB	Funktion Winkelkugelhahn	DE
A maniglia smontata è visibile, sull'asta di manovra, un incavo a forma di L che indica il senso di esecuzione dei fori della sfera, permettendo le seguenti combinazioni:		With disassembled handle, an L-shaped cavity on the handling needle will show the turning way of the ports. Combinations are followings:		Bei abmontiertem Griff ist auf der Spindel eine L-förmige Aussparung sichtbar, welche die Laufriichtung der Kugellöcher zeigt. Folgende Kombinationen sind möglich:	

Funcionnement de la vanne en L	FR	Funcionamiento válvula a L	ES	Funcionamento da válvula com saída em L	PT
La poignée démontable et la bille percée en L permettent les combinaisons suivantes:		Con la maneta desmontada es visible, sobre el eje de maniobra un rebaje en forma de L que indica el sentido de ejecución de los agujeros de la esfera, permitiendo las siguientes combinaciones:		Com a manopla desmontada, na haste de manobra fica visível uma cavidade em forma de L, que indica o sentido de funcionamento dos orifícios da esfera, permitindo as seguintes combinações:	

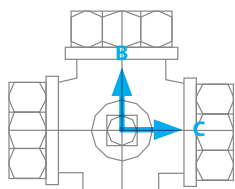

Il flusso passa da B a C (o viceversa)

Flow from B to C (or reverse)

Der Durchfluss verläuft von B nach C (oder umgekehrt)

Passage du fluide de B vers C (et inversement)

El flujo pasa de B a C (o viceversa)

O fluxo passa de B para C (ou vice-versa)

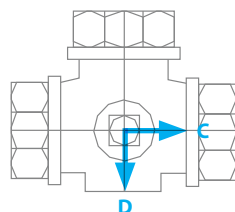

Il flusso è interrotto

Flow is stopped

Der Durchfluss wird unterbrochen

Passage ferme

El flujo es interrumpido

O fluxo é interrompido

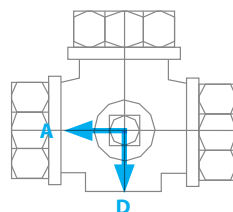

Il flusso è interrotto

Flow is stopped

Der Durchfluss wird unterbrochen

Passage ferme

El flujo es interrumpido

O fluxo é interrompido

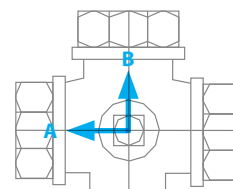

Il flusso passa da A a B (o viceversa)

Flow from A to B (or reverse)

Der Durchfluss verläuft von A nach B (oder umgekehrt)

Passage du fluide de A vers B (et inversement)

El flujo pasa de A a B (o viceversa)

O fluxo passa de A para B (ou vice-versa)

6075

VALVOLA 3 VIE A T FEMMINA G ISO 228

3 WAYS BALL VALVE "T" FEMALE G ISO 228
 3-WEGE T-KUGELHAHN INNENGEW. G ISO 228
 ROBINET 3 VOIES EN T TARAUEE G ISO 228
 VÁLVULA 3 VIAS A T HEMBRA G ISO 228
 VÁLVULA 3 VIAS EM "T" ROSCA FÊMEA G ISO 228

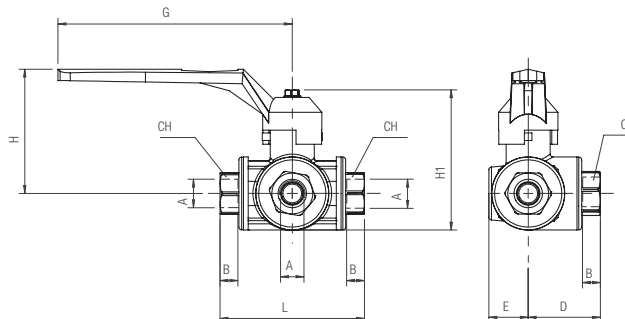

Code	A	B	H	D	L	G	H1	E	CH	DN	PN 20°/40 °C	Pack.
06075 V0 001	1/4	18	65	38.5	77	125	75	22	22	10	55	2
06075 V0 002	3/8	18	65	38.5	77	125	75	22	22	12	55	2
06075 V0 003	1/2	18	65	38.5	77	125	75	22	27	14	50	2
06075 V0 004	3/4	22	83	46	92	145	91	25	34	18	50	2
06075 V0 005	1"	23	96	52	104	170	105	30	41	23	45	2
06075 V0 006	1"1/4	26	102	59	118	170	115	34	50	29	35	1
06075 V0 007	1"1/2	30	109	69	138	170	128	40	57	36	35	1
06075 V0 008	2"	35	139	81	162	260	165	48	70	45	35	1

Funzionamento valvola a T

A maniglia smontata è visibile, sull'asta di manovra, un incavo a forma di T che indica il senso di esecuzione dei fori della sfera, permettendo le seguenti combinazioni:

IT

T valve - Function

With disassembled handle, an T-shaped cavity on the handling needle will show the turning way of the ports. Combinations are followings:

GB

Funktion T-Kugelhahn

Bei abmontiertem Griff ist auf der Spindel eine T-förmige Aussparung sichtbar, welche die Laufrichtung der Kugellöcher zeigt. Folgende Kombinationen sind möglich:

DE

Fonctionnement de la vanne en T

La poignée démontable et la bille percée en T permettent les combinaisons suivantes:

FR

Funcionamiento válvula a T

Con la maneta desmontada es visible, sobre el eje de maniobra, un rebaje en forma de T que indica el sentido de ejecución de los agujeros de la esfera, permitiendo las siguientes combinaciones:

ES

Funcionamento da válvula com saída em T

Com a manopla desmontada é visível, na haste de manobra, uma cavidade em forma de T que indica o sentido normal de funcionamento dos furos da esfera, permitindo a as seguintes combinações:

PT

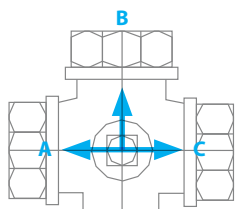

Il flusso passa in tutte le tre direzioni (A-B-C)

Flow to all directions (A-B-C)
 Der Durchfluss verläuft in alle drei Richtungen (A-B-C)
 Passage du fluide dans les trois directions (A-B-C)
 El flujo pasa en todas las tres direcciones (A-B-C)
 O fluxo passa em todas as três direções (A-B-C)

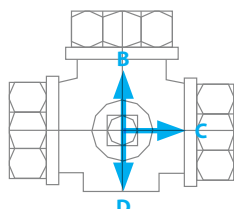

Il flusso passa solamente da B a C (o viceversa)

Flow only from B to C. (or reverse)
 Der Durchfluss verläuft nur von B nach C (oder umgekehrt)
 Passage du fluide de B vers C (et inversement)
 El flujo pasa solamente de B a C (o viceversa)
 O fluxo passa somente de B para C (ou vice-versa)

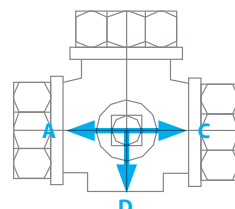

Il flusso passa solamente da A a C (o viceversa)

Flow only from A to C. (or reverse)
 Der Durchfluss verläuft nur von A nach C (oder umgekehrt)
 Passage du fluide de A vers C (et inversement)
 El flujo pasa solamente de A a C (o viceversa)
 O fluxo passa somente de A para C (ou vice-versa)

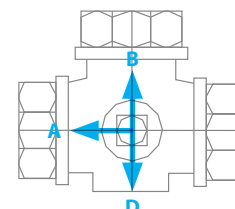

Il flusso passa solamente da A a B (o viceversa)

Flow only from A to B. (or reverse)
 Der Durchfluss verläuft nur von A nach B (oder umgekehrt)
 Passage du fluide de A vers B (et inversement)
 El flujo pasa solamente de A a B (o viceversa)
 O fluxo passa somente de A para B (ou vice-versa)

VALVOLE A SFERA LUCCHETTABILI

BALL VALVES LOCKABLE
KUGELHAHN BOHRUNG VERRIEGELBAR
ROBINETS CADENASSABLES
VÁLVULA DE ESFERA BLOQUEABLE
VÁLVULA ESFERA BLOQUEÁVEL



CARATTERISTICHE TECNICHE

TECHNICAL CHARACTERISTICS
TECHNISCHE ANGABEN
CARACTÉRISTIQUES TECHNIQUES
CARACTERÍSTICAS TÉCNICAS
CARACTERÍSTICAS TÉCNICAS



Norma di Riferimento

Reference standard

Entspricht der Norm

Norme de référence

Normativa de referencia

Norma de referência

PED
2014/68/UE

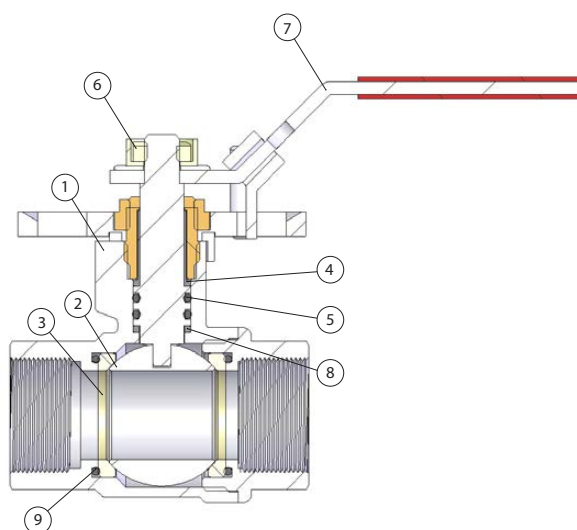

Materiali e Componenti	IT	Component Parts and Materials	GB	Komponenten und Materialien	DE
1 Corpo in ottone nichelato		1 Nickel-plated Brass Body		1 Körper Messing vernickelt	
2 Sfera in ottone nichelato		2 Nickel-plated Brass Ball		2 Kugel Messing vernickelt	
3 Sede in PTFE		3 PTFE Seats		3 Kugelsitzdichtung PTFE	
4 Boccola antigrippaggio in PTFE		4 PTFE anti-seizing bushing		4 PTFE-Anti-Beschlagnahme-Buchsen	
5 Guarnizione in FKM		5 FKM Seal		5 FKM Dichtung	
6 Dado in ottone		6 Brass Nut		6 Messing Mutter	
7 Leva in Acciaio		7 Steel Lever Handle		7 Bedienhebel Stahl	
8 Anello antigrippaggio in PTFE		8 PTFE anti-seizing ring		8 PTFE-Anti-Beschlagnahme-Ring	
9 Guarnizione (Non presente nelle misure 3/8 e 1/2)		9 Seal (Not present in 3/8 and 1/2)		9 Dichtung (Nicht anwesend in 3/8 und 1/2)	

Matériaux et Composants	FR	Materiales y Componentes	ES	Materiais e Componentes	PT
1 Corps: laiton nickelé		1 Cuerpo en latón niquelado		1 Corpo em Latão Niquelado	
2 Bille: laiton nickelé		2 Esfera en latón niquelado		2 Esfera em Latão Niquelado	
3 Joint de frome: PTFE		3 Junta sede esfera PTFE		3 Vedação da sede da esfera em PTFE	
4 Douille anti-grippage de PTFE		4 Buje anti-que agarra de PTFE		4 Bucha anti-aprensão de PTFE	
5 Joint en FKM		5 Junta en FKM		5 Vedações em FKM	
6 Ecrou en laiton		6 Tuerca en latón		6 Porca em Latão	
7 Poignée en acier		7 Leva de maniobra en acero		7 Manopla de manobra em aço	
8 Bague anti-grippage PTFE		8 Anillo anti-que agarra de PTFE		8 Anel anti-aprensão de PTFE	
9 Joint (Non présent en 3/8 et 1/2)		9 Junta (No presente en 3/8 y 1/2)		9 Vedações (Não presente em 3/8 e 1/2)	



Temperature

Temperatures

Temperatur

Températures

Temperaturas

Temperaturas

- 10 °C

+ 100 °C



Fluidi compatibili

Aria compressa / Vuoto / Acqua / Oli

Fluids

Compressed air / Vacuum / Water / Oils

Geeignete Medien

Druckluft / Vakuum / Wasser / Oel

Fluides compatibles

Air comprimé / Vide / Eau / Huile

Fluidos compatibles

Aire comprimido / Vacío / Agua / Aceite

Fluidos compatíveis

Ar comprimido / Vácuo / Água / Óleos



Filettatura

Gas cilindrica conforme ISO 228 Classe A.

IT

Threads

Parallel gas in conformity with ISO 228 Class A.

GB

Gewindearten

Zylindrisches Gewinde nach Norm ISO 228 Classe A.

DE

Filetages

Filetage cylindrique conforme: ISO 228 Class A.

FR

Roscas

Gas cilindrica conforme ISO 228 Classe A.

ES

Roscas

Gas paralela conforme ISO 228 Classe A.

PT

6750L

VALVOLA A SFERA FEMMINA LUCCHETTABILE

BALL VALVES FEMALE LOCKABLE

KUGELHAHN BOHRUNG INNENGEW. VERRIEGELBAR

ROBINET FEMELLE CADENASSABLE

VÁLVULA DE ESFERA HEMBRA BLOQUEABLE

VÁLVULA ESFERA FÊMEA BLOQUEÁVEL

Code	A	L	DN	F	H	G	PN	Pack.
06750 LO 001	3/8	45.5	10	11.5	71	120	40	2
06750 LO 002	1/2	55.5	15	14	74	120	40	2
06750 LO 003	3/4	66	20	16	76.5	120	40	2
06750 LO 004	1"	75	25	17	81	120	40	2
06750 LO 005	1"1/4	85	32	18	99.5	166	40	2
06750 LO 006	1"1/2	99.5	39	19	102.5	166	40	2
06750 LO 007	2"	115	48	21	109	166	40	2

max



Pressure

40 bar



Diagramma Perdite di carico

Pressure drop diagram

Druckverlust diagramm

Diagramme Perte de charge

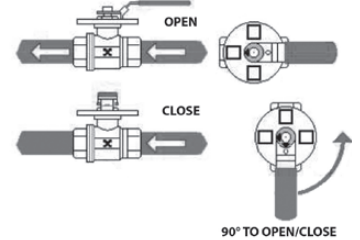
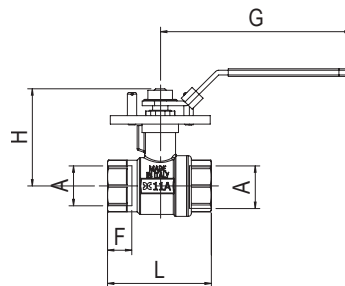
Diagrama Pérdida de carga

Diagrama Queda de pressão

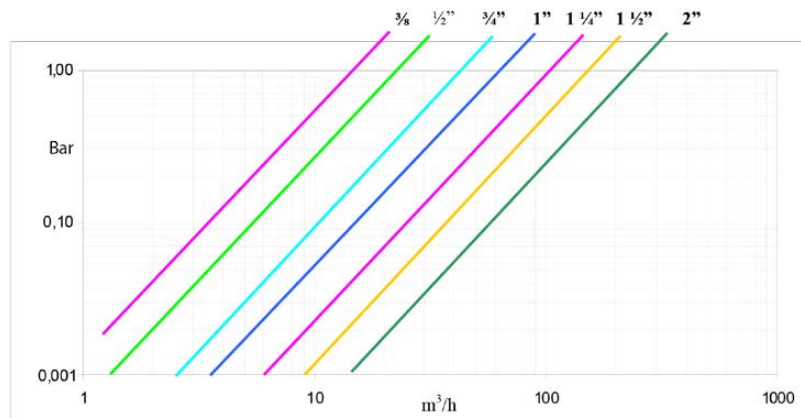

COEFFICIENT K V

COEFFICIENTE K V

Ø	Kv
3/8"	16
1/2"	23
3/4"	43
1"	63
1"1/4	105
1"1/2	170
2"	250

6755L

VALVOLA CON FORO DI SFIATO FEMMINA LUCCHETTABILE

EXHAUST BALL VALVE LOCKABLE
 KUGELHAHN AUS VERNICKELTEM MESSING MIT BOHRUNG FÜR DEKOMPRESSION
 ROBINET AVEC PURGE
 VÁLVULA HEMBRA CON AGUJERO DE DESCOMPRESIÓN
 VÁLVULA ROSCA FÊMEA COM FURO DA DESCOMPRESSÃO

Code	A	L	DN	F	E	H	G	PN	Pack.
06755 L0 001	3/8	45.5	8	14	2	71	120	16	2
06755 L0 002	1/2	55.5	10	14	2	74	120	16	2
06755 L0 003	3/4	68	15	16	2	76.5	120	16	2
06755 L0 004	1"	78	20	17	2.5	81	120	16	2
06755 L0 005	1"1/4	90	32	18	3	99.5	166	16	2
06755 L0 006	1"1/2	100	39	19	3	102.5	166	16	2
06755 L0 007	2"	115	48	21	3	109	166	16	2

max
 **Pressure**
16 bar



Diagramma Perdite di carico

- Pressure drop diagram
- Druckverlust diagramm
- Diagramme Perte de charge
- Diagrama Pérdida de carga
- Diagrama Queda de pressão

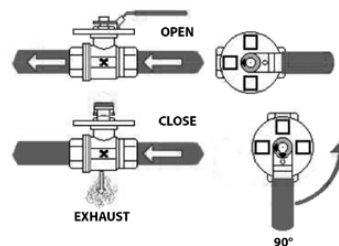
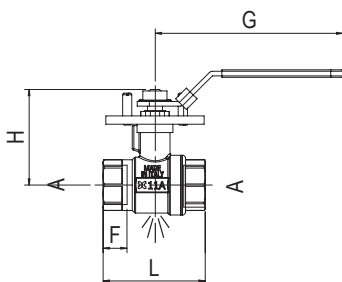
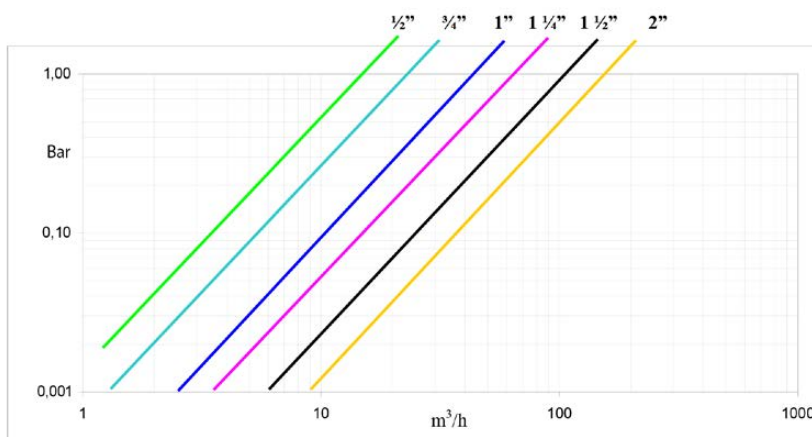

COEFFICIENT K V
COEFFICIENTE K V

Ø	Kv
1/2"	16
3/4"	23
1"	43
1"1/4	64
1"1/2	110
2"	160

6760L

VALVOLA A 3 VIE A "L" FEMMINA LUCCHETTABILE

3 WAYS BALL VALVE "L" FEMALE LOCKABLE
 3-WEGE WINKEL-KUGELHAHN INNENGEW.
 ROBINET EQUERRE 3 VOIES
 VÁLVULA 3 VIAS A L HEMBRA
 VÁLVULA 3 VIAS EM "L" ROSCA FÊMEA

Code	A	L	DN	F	H	G	PN	Pack.
06760 L0 002	1/2	56	10	14	61.5	120	25	2
06760 L0 003	3/4	68	15	16	65	120	25	2
06760 L0 004	1"	78	20	17	69	120	25	2
06760 L0 005	1"1/4	90	25	18	74	120	25	2
06760 L0 006	1"1/2	100	32	19	80	120	25	2
06760 L0 007	2"	115	40	21	86	120	25	1
06760 L0 008	3"	180	68	25	132	246	25	1

max
 **Pressure**
25 bar

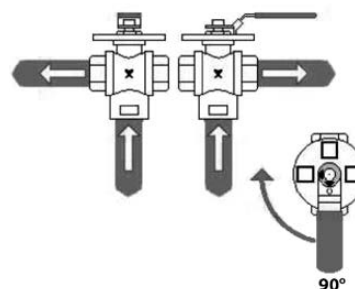
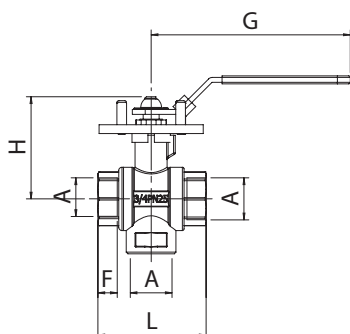

6765L

VALVOLA A 3 VIE A "T" FEMMINA LUCCHETTABILE

3 WAYS BALL VALVE "T" FEMALE LOCKABLE
 3-WEGE T-KUGELHAHN INNENGEW.
 ROBINET 3 VOIES EN T TARAUEE
 VÁLVULA 3 VIAS A T HEMBRA
 VÁLVULA 3 VIAS EM "T" ROSCA FÊMEA

Code	A	L	DN	F	H	G	PN	Pack.
06765 L0 002	1/2	56	10	14	61.5	120	25	2
06765 L0 003	3/4	68	15	16	65	120	25	2
06765 L0 004	1"	78	20	17	69	120	25	2
06765 L0 005	1"1/4	90	25	18	74	120	25	2
06765 L0 006	1"1/2	100	32	19	80	120	25	2
06765 L0 007	2"	115	40	21	86	120	25	1
06765 L0 008	3"	180	68	25	132	246	25	1

max
Pressure
25 bar



Diagramma Perdite di carico
 Pressure drop diagram
 Druckverlust diagramm
 Diagramme Perte de charge
 Diagrama Pérdida de carga
 Diagrama Queda de pressão

6760L - 6765L

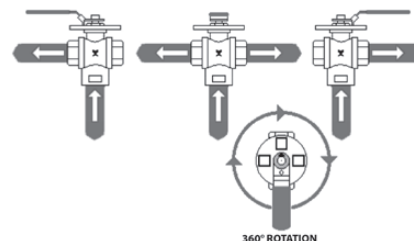
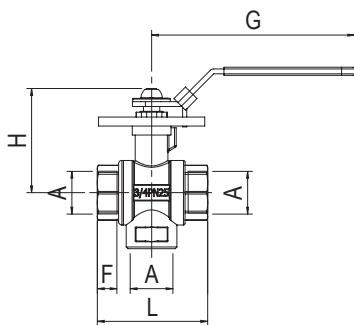
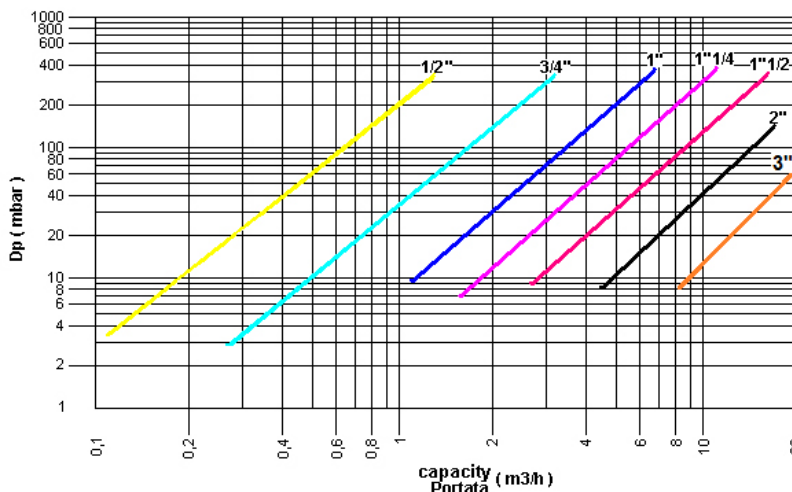

COEFFICIENT K V
COEFFICIENTE K V

Ø	Kv
1/2"	2,27
3/4"	5,5
1"	10,76
1"1/4	17,26
1"1/2	24,97
2"	45,09
3"	105

LUC01

LUCCHETTO IN OTTONE 40 MM

BRASS PADLOCK 40 MM
 MESSINGSCHLÖSSER 40 MM
 CADENAS EN LAITON 40 MM
 CANDADO DE LATÓN 40 MM
 CADEADO DE BRONZE 40 MM

Code	Ø	Pack.
LUC01 00 002	6	1



FILTRO A Y

Y FILTER
Y FILTER
FILTRE Y
FILTRO A Y
FILTRO Y



CARATTERISTICHE TECNICHE

TECHNICAL CHARACTERISTICS
TECHNISCHE ANGABEN
CARACTÉRISTIQUES TECHNIQUES
CARACTERÍSTICAS TÉCNICAS
CARACTERÍSTICAS TÉCNICAS



Materiali e Componenti	IT	Component Parts and Materials	GB	Komponenten und Materialien	DE
<ul style="list-style-type: none"> Corpo in ottone dal 1/4 al 2" Corpo in bronzo dal 2"1/2 al 4" Tappo in ottone Filtro in acciaio AISI 304 Guarnizione corpo in NBR 		<ul style="list-style-type: none"> Brass body from 1/4 to 2" Bronze body from 2"1/2 to 4" Brass Cap Steel AISI 304 Strainer NBR Body Seal 		<ul style="list-style-type: none"> Körper Messing von 1/4 bis 2" Körper Bronze von 2"1/2 bis 4" Verschlussdeckel Messing Filter Edelstahl AISI 304 Körperdichtung NBR 	
Matériaux et Composants	FR	Materiales y Componentes	ES	Materiais e Componentes	PT
<ul style="list-style-type: none"> Corps en laiton de 1/4 à 2" Corps en bronze de 2"1/2 à 4" Bouchon en laiton Filtre inox AISI 304 Joint de corps: NBR 		<ul style="list-style-type: none"> Cuerpo en latón de 1/4 a 2" Cuerpo en Bronce 2"1/2 a 4" Tapón en latón Filtro en acero AISI 304 Junta cuerpo en NBR 		<ul style="list-style-type: none"> Corpo em latão de 1/4 al 2" Corpo em bronze de 2"1/2 al 4" Tampão em latão Filtro em aço AISI 304 Vedação corpo em NBR 	



Pressione massima

Maximum Pressure
Maximaler Betriebsdruck
Pression maximum
Presión máxima
Pressão máxima

1/4 ÷ 2" 20 bar
2" - 1/2 ÷ 4" 16 bar



Temperatura di esercizio in assenza di vapore

Working temperature without steam
Betriebstemperatur ohne Dampf
Température d'utilisation sans vapeur
Temperatura de ejercicio con ausencia de vapor
Temperatura de trabalho sem presença de vapor

- 20 °C
+ 110 °C



Soglia di filtrazione

Filtration degree
Filterfeinheit
Degré de filtration
Grado de filtración
Grau de filtragem

1/4 ÷ 2" 500 µm
2"1/2 - 3" - 4" 800 µm



Fluidi compatibili

Acqua / Oli / Aria
Fluids
Water / Oils / Air
Geeignete Medien
Wasser / Oel / Air
Fluides compatibles
Eau / Huile / Air
Fluidos compatibles
Agua / Aceite / Aire
Fluidos compatíveis
Água / Óleo / Ar



Filettatura Gas cilindrica conforme ISO 228 Classe A.	IT Threads Parallel gas in conformity with ISO 228 Class A.	GB Gewindearten Zylindrisches Gewinde nach Norm ISO 228 Classe A.	DE
Filetages Filetage cylindrique conforme: ISO 228 Classe A.	FR Roscas Gas cilindrica conforme ISO 228 Classe A.	ES Roscas Gas paralela conforme ISO 228 Classe A.	PT



Diagramma Perdite di carico

- Pressure drop diagram
- Druckverlust diagramm
- Diagramme Perte de charge
- Diagrama Pérdida de carga
- Diagrama Queda de pressão

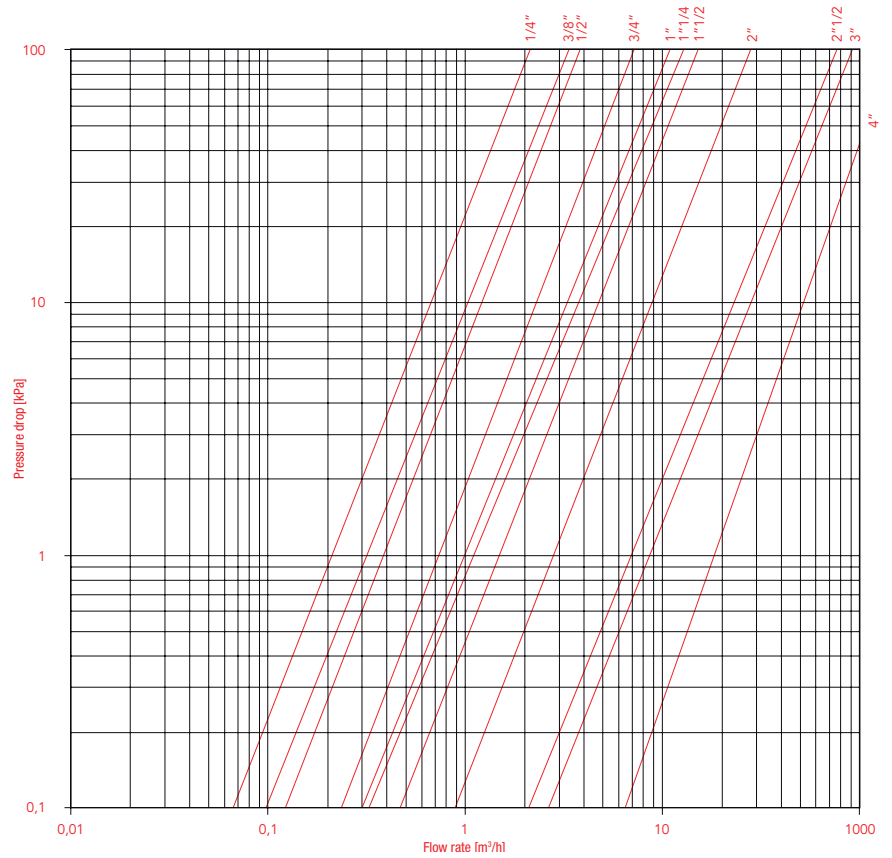

6035

FILTRO "Y"
"Y" FILTER
"Y" FILTER
FILTRE "Y"
FILTRO "Y"
FILTRO "Y"

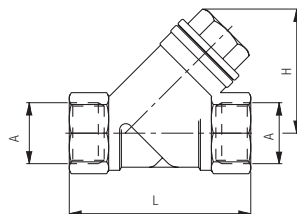

Code	A	DN	L	H	PN	KV	Pack.
06035 00 001	1/4	8	55	40	20	2.2	10
06035 00 002	3/8	10	55	40	20	3.4	10
06035 00 003	1/2	15	58	40	20	4.5	10
06035 00 004	3/4	20	70	50	20	7.9	10
06035 00 005	1"	25	87	56	20	11	5
06035 00 006	1 1/4	32	96	64	20	16	2
06035 00 007	1 1/2	40	106	73	20	22	2
06035 00 008	2"	50	126	89	20	35	1
06035 00 009	2 1/2	65	150	107	16	60	1
06035 00 010	3"	80	170	120	16	83	1
06035 00 011	4"	100	219	161	16	100	1

VALVOLE DI RITEGNO

NO RETURN VALVE
RÜCKSCHLAGVENTIL
CLAPET ANTI-RETOUR
VÁLVULA DE RETENCIÓN
VÁLVULAS ANTI-RETORNO



CARATTERISTICHE TECNICHE

TECHNICAL CHARACTERISTICS
TECHNISCHE ANGABEN
CARACTÉRISTIQUES TECHNIQUES
CARACTERÍSTICAS TÉCNICAS
CARACTERÍSTICAS TÉCNICAS



Norma di Riferimento

Reference standard

Entspricht der Norm

Norme de référence

Normativa de referencia

Norma de referência

1907/2006

REACH ✓

2011/65/CE

RoHS ✓

PED
2014/68/UE

SILICON
FREE

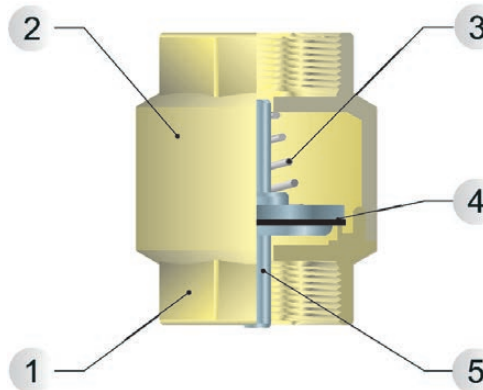

Materiali e Componenti	IT	Component Parts and Materials	GB	Komponenten und Materialien	DE
1 Corpo in Ottone		1 Brass Body		1 Körper Messing	
2 Coperchio in Ottone		2 Brass Cover Cap		2 Einschraubkörper Messing	
3 Molla in acciaio inox		3 Stainless steel Spring		3 Feder Edelstahl	
4 Guarnizione in NBR		4 NBR Seal		4 Dichtung NBR	
5 Otturatore in plastica		5 Plastic Shutter		5 Verschluss Kunststoff	

Matériaux et Composants	FR	Materiales y Componentes	ES	Materiais e Componentes	PT
1 Corps: laiton		1 Cuerpo en latón		1 Corpo em Latão	
2 Corps: laiton		2 Cuerpo en latón		2 Cobertura em Latão	
3 Ressort: inox		3 Muelle en Acero Inox		3 Mola em aço inox	
4 Joint: NBR		4 Junta en NBR		4 Vedação em NBR	
5 Obturateur: plastique		5 Obturador en material plástico		5 Obturador em plástico	



Pressioni

Pressures

Druckbereich

Pressions

Presiones

Pressões

DN	
3/8 ÷ 1"	1"-1/4 ÷ 2"
12 bar	10 bar



Temperature

Temperatures

Temperatur

Temperatures

Temperaturas

Temperaturas

0 °C
+ 90 °C



Fluidi compatibili

Aria compressa / Acqua / Oli

Fluids

Compressed air / Water / Oils

Geeignete Medien

Druckluft / Wasser / Öl

Fluides compatibles

Air comprimé / Eau / Huile

Fluidos compatibles

Aire comprimido / Agua / Aceite

Fluidos compatíveis

Ar comprimido / Água / Óleo

6036

VALVOLA DI RITEGNO

NON RETURN VALVE
RÜCKSCHLAGVENTIL
CLAPET ANTI-RETOUR
VÁLVULA DE RETENCIÓN
VÁLVULA ANTI-RETORNO

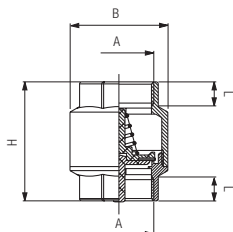

Code	A	H	L	B	Pressioni d'apertura Opening pressure Öffnungsdruck Pression d'ouverture Presiones de apertura Pressões de abertura (mbar)	Pack.
06036 00 007	3/8	49	11	34	24.5	10
06036 00 001	1/2	49	11	34	24.5	10
06036 00 002	3/4	54	11	42	27.1	5
06036 00 003	1"	59	11.5	48	19.4	5
06036 00 004	1 1/4	67	14.5	60	34.5	2
06036 00 005	1 1/2	72	14.5	69	15.9	2
06036 00 006	2"	77	14.5	85	10.8	1

6037

VALVOLA DI FONDO

FINAL VALVE
ENDVENTIL
CLAPET ANTI RETOUR DE FIN DE LIGNE
VÁLVULA DE FONDO
VÁLVULA DE FUNDO

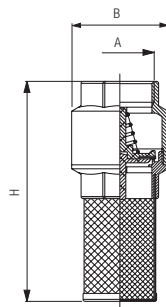

Code	A	H	B	Pack.
06037 00 001	1/2	81	34	10
06037 00 002	3/4	87	42	5
06037 00 003	1"	97	48	5
06037 00 004	1 1/4	110	60	4
06037 00 005	1 1/2	125	69	2
06037 00 006	2"	145	85	1

Soglia di filtrazione - Filtration threshold - Filterfeinheit
Capacité de filtration - Grado de filtración - Limite de filtragem

1.000 µm

6038

FILTRO IN RETE STIRATA IN AISI 304

AISI 304 STRECHED NET FILTER
NETZFILTER AUS AISI 304
FILTRE EN AISI 304
FILTRO DE MALLA EN AISI 304
FILTRO DE TELA PARA VÁLVULA DE FUNDO EM AISI 304

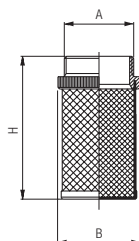

Code	A	H	B	Pack.
06038 00 002	1/2	50	28	10
06038 00 003	3/4	56	33	5
06038 00 004	1"	58	41	5
06038 00 005	1 1/4	69	50	5
06038 00 006	1 1/2	78	55	5
06038 00 007	2"	96	67	1

Soglia di filtrazione - Filtration threshold - Filterfeinheit
Capacité de filtration - Grado de filtración - Limite de filtragem

1.000 µm

