

 50000 Pag. 1.7	 50010 Pag. 1.7	 50020 Pag. 1.8	 50030 Pag. 1.8	 50040 Pag. 1.9	 50050 Pag. 1.9	 50055 Pag. 1.9	 50100 Pag. 1.10	 50106 Pag. 1.10
 50111 Pag. 1.10	 50116 Pag. 1.11	 50121 Pag. 1.11	 50126 Pag. 1.12	 50130 Pag. 1.12	 50200 Pag. 1.12	 50211 Pag. 1.13	 50216 Pag. 1.13	 50223 Pag. 1.13
 50226 Pag. 1.14	 50230 Pag. 1.14	 50310 Pag. 1.14	 50326 Pag. 1.15	 50500 Pag. 1.15	 50510 Pag. 1.15	 50550 Pag. 1.16	 50560 Pag. 1.16	 51410 Pag. 1.16
 51420 Pag. 1.17	 51430 Pag. 1.17	 51440 Pag. 1.17	 50600 Pag. 1.18	 50610 Pag. 1.18	 50615 Pag. 1.18	 50625 Pag. 1.19	 50700 Pag. 1.19	 55800 Pag. 1.19
 55801 Pag. 1.20	 55802 Pag. 1.20	 50900 Pag. 1.21	 50980 Pag. 1.21	 50990 Pag. 1.21	 50006 Pag. 1.22			

RACCORDI AUTOMATICI

PUSH-IN FITTINGS

STECKVERSCHRAUBUNGEN

RACCORDS INSTANTANÉS

RACORDAJE AUTOMÁTICO

CONEXÕES PUSH-IN

Serie 50000



La serie 50.000, prima versione istantanea, lanciata da Aignep, è l'espressione chiara della tecnologia affidabile e largamente provata nelle applicazioni pneumatiche.

Principali vantaggi

- Connessione e sconnessione istantanea
- Pieno passaggio e tenuta al vuoto grazie a guarnizioni sagomate
- Tre tipologie di filettature, BSPP, BSPT (universal short) e Metrica
- Robustezza perché realizzato in metallo
- Vasta gamma a disposizione per soddisfare le installazioni più esigenti
- Silicon Free

Applicazioni

- Automazione Pneumatica
- Automotive
- Industria tessile, imballaggio
- Circuiti aria compressa
- Acqua industriale
- Vuoto

La série 50.000 est la première gamme lancée sur le marché par Aignep. C'est une des références en terme de qualité, de fiabilité et d'endurance pour les applications pneumatiques.

Principaux avantages

- Connexion et déconnexion instantanée
- Plein débit et tenue au vide industriel grâce à des joints de forme
- 3 filetages disponibles, BSPP, BSPT (universal court) et Métrique
- Robustesse Métallique
- Large gamme
- Sans silicone

Applications

- Automatismes Pneumatiques
- Automobile
- Textile, emballage
- Circuit d'Air comprimé
- Eau industrielle
- Vide

The 50.000 serie is the first line launched on the market from Aignep. It is the icon of quality, reliability and endurance in the pneumatic field.

Main advantages

- Quick connection and disconnection
- Full Flow and Vacuum resistant tank to special shaped seals
- 3 threads available, BSPP, BSPT (universal short) and Metric
- Metal Robustness
- Wide Range
- Silicon Free

Applications

- Pneumatic Automation
- Automotive
- Textile, Packaging
- Compressed Air Circuit
- Industrial water
- Vacuum

La serie 50.000, primera versión instantánea, lanzada por Aignep, es la expresión más clara de la tecnología fiable y ampliamente probada en las aplicaciones neumáticas.

Principales ventajas

- Conexión y desconexión instantánea
- Paso total y estanqueidad al vacío gracias a las juntas moldeadas
- Tres tipos de roscas, BSPP, BSPT (universal short) y métricas
- Robustez, realizado en metal
- Amplia gama disponible para satisfacer las instalaciones más exigentes
- Libre de silicona

Aplicaciones

- Automatización Neumática
- Automoción
- Industria textil, envasado
- Circuitos de aire comprimido
- Agua industrial
- Vacío

Die 50.000er-Serie von Aignep wurde als erste Version auf dem Markt eingeführt. Sie ist Symbol für Qualität, Zuverlässigkeit und bewährter Technologie im pneumatischen Bereich.

Hauptvorteile

- Schnelle Verbindung und Trennung
- Voller Durchfluss und Vakuumfestigkeit, dank spezieller Formdichtungen
- Drei Gewindearten, BSPP, BSPT (universal kurz) und metrisch
- Robustes Metall
- Große Auswahl, auch für anspruchsvollste Installationen.
- Silikonfrei

Anwendungen

- Pneumatische Automation
- Automobil-Industrie
- Textil-, Verpackungsindustrie
- Druckluftkreislauf
- Brauchwasser
- Vakuum

A série 50.000 é a primeira linha lançada no mercado pela Aignep. Ela é um ícone da qualidade, confiabilidade e durabilidade no campo da pneumática.

Principais vantagens

- Rápida conexão e desconexão.
- Vazão total e resistência ao vácuo graças ao design especial das suas vedações
- 3 tipos de rosca disponíveis: BSPP, BSPT (universal short) & Métrica
- Robustez Metálica
- Grande Range de itens
- Livre de Silicose

Aplicações

- Automação Pneumática
- Automotiva
- Têxtil, embalagens
- Circuitos de Ar Comprimido
- Água industrial
- Vácuo



CARATTERISTICHE TECNICHE

TECHNICAL CHARACTERISTICS
TECHNISCHE ANGABEN
CARACTÉRISTIQUES TECHNIQUES
CARACTERÍSTICAS TÉCNICAS
CARACTERÍSTICAS TÉCNICAS



Norma di Riferimento

Reference standard

Entspricht der Norm

Norme de référence

Normativa de referencia

Norma de referència

1907/2006

REACH ✓

2011/65/CE

RoHS ✓

PED

2014/68/UE

ISO
14743:2020

SILICON
FREE

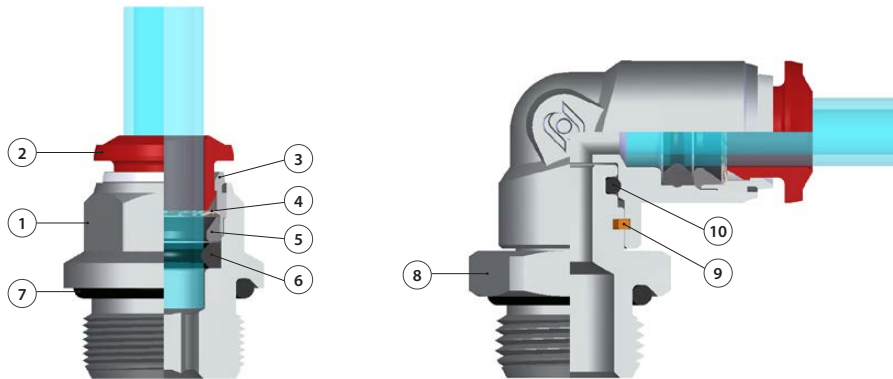

Materiali e Componenti

- 1 Corpo in ottone nichelato
- 2 Spintore sgancio tubo in resina acetatica
- 3 Capsula in ottone nichelato
- 4 Pinza d'aggraffaggio in acciaio inox AISI 301
- 5 Anello di posizionamento in tecnopolimero
- 6 Guarnizione sagomata in NBR
- 7 Guarnizione filetto in NBR
- 8 Basetta Filettata in Ottone Nichelato
- 9 Seeger
- 10 Guarnizione in NBR

IT

Component Parts and Materials

- 1 Nickel-plated brass Body
- 2 Acetalic resin Collet
- 3 Nickel-plated brass Capsule
- 4 Steel AISI 301 Clamping washer
- 5 Technopolymeric positioning ring
- 6 NBR Molded seal
- 7 NBR Thread packing
- 8 Base Threaded Nickel Plated Brass
- 9 Seeger
- 10 NBR seal

GB

Komponenten und Materialien

- 1 Körper Messing vernickelt
- 2 Rohr Lösering Acetal
- 3 Haltering Messing vernickelt
- 4 Zahnscheibe Edelstahl AISI 301
- 5 Positionierring Technopolymer
- 6 Lippendichtung nbr
- 7 Gewindeabdichtung nbr
- 8 Gewindebasis Messing vernickelt
- 9 Seeger
- 10 Lippendichtung NBR

DE

Matériaux et Composants

- 1 Corps: Laiton nickelé
- 2 Poussoir: Résine acétal
- 3 Capsule de retenue: Laiton nickelé
- 4 Rondelle d'accrochage: AISI 301
- 5 Anneau de positionnement: Technopolymère
- 6 Joint à lèvres: NBR
- 7 Joint d'étanchéité du filetage: NBR
- 8 Bague de sécurité en laiton nickelé
- 9 Seeger
- 10 Joint en NBR

FR

Materiales y Componentes

- 1 Cuerpo en latón niquelado
- 2 Anillo de extracción tubo en resina acética
- 3 Cápsula en latón niquelado
- 4 Pinza de agarre en acero inox AISI 301
- 5 Anillo de posicionamiento en tecnopolimero
- 6 Junta de forma en NBR
- 7 Junta rosca en NBR
- 8 Base roscada en latón niquelado
- 9 Seeger
- 10 Junta en NBR

ES

Materiais e Componentes

- 1 Corpo em latão niquelado
- 2 Anilha de liberação do tubo em resina acética
- 3 Cápsula de latão niquelado
- 4 Pinça de travamento em aço-inox AISI 301
- 5 Anel de posicionamento em tecnopolimero
- 6 Vedação em NBR
- 7 Vedação da rosca em NBR
- 8 Base roscada em latão niquelado
- 9 Seeger
- 10 Vedação em NBR

PT



Pressioni

Pressures

Druckbereich

Pressions

Presiones

Pressões

- 0.99 bar (-0.099 MPa)

20 bar (2.0 MPa)



Temperature

Temperatures

Temperatur

Températures

Temperaturas

Temperaturas

- 20 °C

+ 80 °C



Fluidi compatibili

Aria compressa / Vuoto / Acqua

Fluids

Compressed air / Vacuum / Water

Geeignete Medien

Druckluft / Vakuum / Wasser

Fluides compatibles

Air comprimé / Vide / Eau

Fluidos compatibles

Aire comprimido / Vacío / Agua

Fluidos compatíveis

Ar comprimido / Vácuo / Água



Tubi di Collegamento

Tubi in materiale plastico:

PA6, PA11, PA12, Polietilene, *Poliuretano, PTFE, FEP.

*Utilizzo da 90 a 98 Shore, per la massima prestazione è consigliato 98 Shore A.

IT

Connection Tubes

Plastic tubes:

PA6, PA11, PA12, Polyethylene, *Polyurethane, PTFE, FEP.

*Use from 90 to 98 Shore, for maximum performance is recommended 98 Shore A.

GB

Geeignete Rohre

Kunststoffrohre:

PA6, PA11, PA12, Polyethylene, *Polyurethan, PTFE, FEP.

*Verwenden Sie 90 bis 98 Shore, für maximale Leistung wird 98 Shore A empfohlen.

DE

Tubes Conseillés

Tubes plastiques:

PA6, PA11, PA12, Polyéthylène, *Polyuréthane, PTFE, FEP.

*Utilisation de 90 à 98 Shore, pour une performance maximale recommandée 98 Shore A.

FR

Tubos de Conexión

Tubos en material plástico:

PA6, PA11, PA12, Polietileno, *Poliuretano, PTFE, FEP.

*Uso de 90 a 98 Shore, para un máximo rendimiento se recomienda 98 Shore A.

ES

Tubos de Conexão

Tubos em material plástico:

PA6, PA11, PA12, Polietileno, *Poliuretano, PTFE, FEP.

*Uso de 90 a 98 Shore, para o desempenho máximo é recomendado 98 Shore A.

PT



Filettatura	IT	Threads	GB	Gewindearten	DE
Gas conica "UNIVERSAL SHORT". Gas conica conforme ISO 7.1, BS 21, DIN 2999. Gas cilindrica conforme ISO 228 Classe A. Metrica conforme ISO R/262.		"UNIVERSAL SHORT" Tapered thread. Tapered gas in conformity with ISO 7.1, BS 21, DIN 2999. Parallel gas in conformity with ISO 228 Class A. Metric in conformity with ISO R/262.		Konisches Gewinde "UNIVERSAL SHORT". Konisches Gewinde nach Norm ISO 7.1, BS 21, DIN 2999. Zylindrisches Gewinde nach Norm ISO 228 Classe A. Metrisches Gewinde nach Norm ISO R/262.	
Filetages	FR	Roscas	ES	Roscas	PT
Filetage conique "UNIVERSAL SHORT". Filetage conique conforme: ISO 7.1, BS 21, DIN 2999. Filetage cylindrique conforme: ISO 228 Classe A. Filetage métrique conforme: ISO R/262.		Gas cónica "UNIVERSAL SHORT". Gas cónica conforme ISO 7.1, BS 21, DIN 2999. Gas cilíndrica conforme ISO 228 Classe A. Métrica conforme ISO R/262.		Gas cónica "UNIVERSAL SHORT". Gas cónica conforme ISO 7.1, BS 21, DIN 2999. Gas paralela conforme ISO 228 Classe A. Métrica conforme ISO R/262.	



UNIVERSAL SHORT

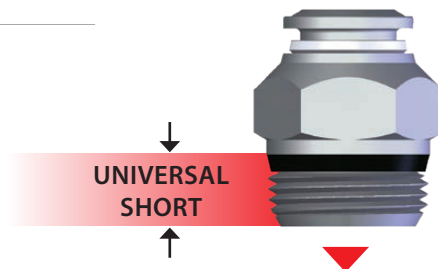

NPT NPTF	Conica Tapered Konisch Conique Cónica Cônica	ISO 7 BSPP	Cilindrica Parallell Zylindrisch Cylindrique Cilíndrica Paralela	ISO 7 BSPT PT	Conica Tapered Konisch Conique Cónica Cônica	ISO 228 BSP PF	Cilindrica Parallell Zylindrisch Cylindrique Cilíndrica Paralela
---------------------------	---	-----------------------------	---	--	---	---	---

"UNIVERSAL SHORT"	IT	"UNIVERSAL SHORT"	GB	"UNIVERSAL SHORT"	DE
La filettatura conica "UNIVERSAL SHORT" è progettata per soddisfare le seguenti caratteristiche: • ridurre la lunghezza d'ingombro; • ridurre la chiave rispetto ad alcuni raccordi con filettature cilindriche; • consentire l'accoppiamento con diversi standard di filettature femmina sia coniche che cilindriche.		The "UNIVERSAL SHORT" taper thread has been designed to offer the following advantages to the users: • reduced overall length; • smaller hex dimensions compared to the parallel threads; • to allow the assembly with different female threads both taper as well as parallel.		Das konische Gewinde "UNIVERSAL SHORT" ist so konzipiert, dass folgende Vorteile erzielt werden: • Reduzierung der Länge des Gewindes-kürzere Montagezeit; • Reduzierung der Schlüsselweite im Vergleich von Verschraubungen mit zylindrischen Gewinden-geringer Lochabstand; • Ermöglicht den Einsatz in verschiedene Gewindearten, sowie in konische- und zylindrische Innengewinde.	

"UNIVERSAL SHORT"	FR	"UNIVERSAL SHORT"	ES	"UNIVERSAL SHORT"	PT
Le filetage conique "UNIVERSAL SHORT" a été conçu pour satisfaire les exigences suivantes: • réduire la longueur d'encombrement; • réduire les dimensions hexagonales par rapport au filetage cylindrique; • permettre le montage avec divers taraudages standards soit coniques soit cylindriques.		La rosca cónica "UNIVERSAL SHORT" ha sido proyectada para satisfacer las siguientes características: • reducir la longitud; • reducir la llave respecto a algunos racores con rosca cilíndrica; • consentir el acoplamiento con diferentes standard de rosca hembra sean cónicas o cilíndricas.		A rosca cónica "UNIVERSAL SHORT" é projetada para satisfazer às seguintes características: • reduzir o comprimento da conexão; • reduzir o dimensional com relação às rosca paralelas; • permitir o acoplamento da conexão a diferentes tipos de rosca fêmea, sejam elas cónicas ou paralelas.	

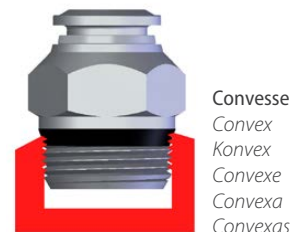
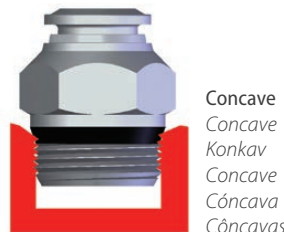
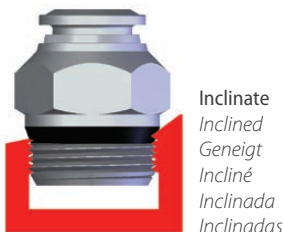

	IT		GB		DE
Consentire una completa tenuta anche su superfici non perfettamente piane, concave, convesse o inclinate, con diversi smussi o raggi.		To ensure the right tightening also with surfaces not perfectly flat, without spot-facing, concave convex and with different kinds of chamfers or radius.		Eine vollständige Abdichtung ist auch auf unebenen Flächen, wie geneigt, konkav oder konvex und mit unterschiedlichen Radien oder Fasen gewährleistet.	

	FR		ES		PT
Pour permettre une parfaite étanchéité même sur des surfaces non planes, concaves, convexas ou inclinées et avec différents chanfreins ou rayons.		Consentir una completa estanqueidad incluso en superficies no perfectamente planas, cóncavas, convexas o inclinadas, con diferentes ángulos o radios.		Permite um aperto correto em superfícies não perfeitamente planas, côncavas, convexas ou inclinadas, com diferentes chanfros ou raios.	



Coppia di serraggio

Torque specifications

Angaben Drehmoment

Couple de serrage

Par de apriete

Especificações de Torque



ISO 228



"UNIVERSAL SHORT"

I valori di rottura possono variare in base all'articolo
 Breaking values may vary according to the item
 Die maximal werte dienen nur zu Informationszwecken
 Les valeurs maximales sont présentées à titre indicatif
 Los valores de rotura pueden variar en función del artículo
 Os valores de ruptura podem variar em função do item

MISURA MEASURE GRÖSSE DIMENSIONS MEDIDA MEDIDA	COPPIA CONSIGLIATA Nm RECOMMENDED TORQUE Nm EMPFOHLENES DREHMOMENT Nm COUPLE DE SERRAGE Nm PAR ACONSEJADO Nm TORQUE RECOMENDADO Nm	COPPIA DI ROTTURA Nm BREAKING TORQUE Nm ABSCHERDREHMOMENT Nm COUPLE DE RUPTURE Nm PAR DE ROTURA Nm TORQUE DE RUPTURA Nm
M5	0,8	3,2
M7	3	8
M8	3	8
1/8	3	8
1/4	9	30
3/8	10	60
1/2	12	50

MISURA MEASURE GRÖSSE DIMENSIONS MEDIDA MEDIDA	COPPIA MINIMA CONSIGLIATA Nm RECOMMENDED MINIMUM TORQUE Nm EMPFOHLENES DREHMOMENT Nm COUPLE DE SERRAGE Nm PAR MÍNIMO ACONSEJADO Nm TORQUE MÍNIMO RECOMENDADO Nm	COPPIA MASSIMA CONSIGLIATA Nm RECOMMENDED MAX TORQUE Nm ABSCHERDREHMOMENT Nm COUPLE DE RUPTURE Nm PAR MÁXIMO ACONSEJADO Nm TORQUE MÁXIMA RECOMENDADO Nm
1/8	5	7
1/4	5	7
3/8	5	7
1/2	5	7

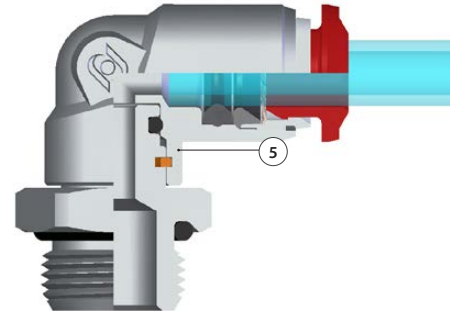
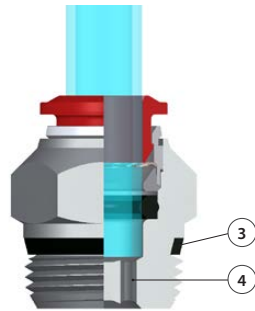
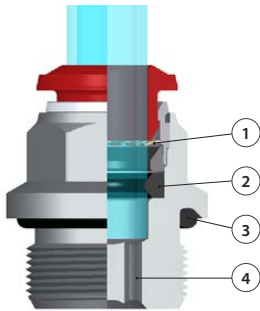

Vantaggi

IT

Advantages

GB

Vorteile

DE

- 1 La pinza in acciaio inox garantisce il perfetto aggraffaggio di tubi di qualsiasi materiale senza danneggiarne la superficie. Il collegamento tra tubo e raccordo assicura una tenuta totale anche in condizioni di urti e vibrazioni.
- 2 La particolare geometria della guarnizione permette inoltre l'utilizzo dei raccordi anche con il vuoto.
- 3 Tutte le filettature di questa serie sono state dotate di elementi di tenuta che permettono l'immediato utilizzo dei raccordi riducendo notevolmente i tempi di installazione.
- 4 Tutti i raccordi diritti possono essere montati anche con chiave esagonale ed è possibile utilizzarli anche in spazi molto ridotti.
- 5 Raccordo orientabile con anello di sicurezza interno. Garantisce maggiore durata alla rotazione e trazione.

- 1 The washer is made in stainless steel ensures the perfect tube clamping with every kinds of materials without damage the surface. The connection between the tube and the fitting ensure a total tightness even in severe conditions such as impact and vibrations.
- 2 The particular geometric shape of the seal ensure the perfect tightness even with vacuum.
- 3 All of threads from this range have been equipped with tightening parts which allow the direct assembly of the fittings, reducing the installation time.
- 4 All the straight fittings can be assembled also with Allen wrench and it is possible to use them in reduced spaces.
- 5 Orienting fitting with safety ring inside. Improved durability to the rotation and traction.

- 1 Konisches Gewinde "kurz" Die Zahnscheibe sorgt für eine perfekte Halterung des Rohres ohne die Oberfläche zu beschädigen. Die Dichtheit zwischen Rohr und Verschraubung ist auch bei Erschütterungen und Vibrationen gewährleistet.
- 2 Die besondere Geometrie der Dichtung ermöglicht auch die Anwendung der Verschraubungen in Verbindung mit Vakuum.
- 3 Alle Verschraubungen in dieser Serie sind mit Gewindeabdichtungen ausgestattet, die den sofortigen Einsatz ermöglichen und daher die Montagezeit stark reduzieren.
- 4 Alle geraden Verschraubungen können auch mit Inbuschüsseln montiert werden, daher kleiner Lochabstand möglich.
- 5 Flexible Montage mit Sicherungsring innen. Verbesserte Beständigkeit gegenüber der Drehung und Traktions.

Avantages

FR

Ventajas

ES

Vantagens

PT

- 1 La rondelle en acier inoxydable garantit la parfaite tenue du tube quelle que soit la matière et sans l'endommager. La connexion entre le tube et le raccord assure une étanchéité totale même dans des conditions d'impact ou de vibrations.
- 2 La spécificité géométrique du joint permet l'utilisation des raccords avec le vide.
- 3 Tous les filetages de cette série sont équipés d'éléments d'étanchéité qui permettent l'utilisation immédiate des raccords réduisant ainsi le temps d'installation.
- 4 Tous les raccords droits peuvent être aussi montés avec une clé hexagonale pour permettre une utilisation dans des espaces réduits.
- 5 Accessoire de fixation réglable avec anneau de sécurité à l'intérieur. Amélioration de la durée de la rotation et de traction.

- 1 La pinza en acero inox garantiza el perfecto agarre del tubo de cualquier material sin perjudicar la superficie. La conexión entre tubo y racor asegura una estanqueidad total aun en condiciones de impacto o vibración.
- 2 La particular geometría de la junta garantiza una perfecta estanqueidad incluso en vacío.
- 3 Todas las rosas de esta serie están fabricadas con junta de cierre que permite la inmediata utilización del racor reduciendo notablemente el tiempo de instalación.
- 4 Todos los racores rectos pueden montarse también con llave hexagonal y es posible utilizarlos incluso en espacios muy reducidos.
- 5 Montaje ajustable con siSCREWa de seguridad interior. La mejora de la durabilidad a la rotación y tracción.

- 1 A pinça em aço-inox garante o perfeito travamento do tubo de qualquer material sem danificar a superfície do mesmo. A conexão entre o tubo e a conexão assegura uma vedação total também em condições de impactos e vibrações.
- 2 A geometria particular da vedação permite a utilização da conexão também para aplicações com vácuo.
- 3 Todas as rosas desta série são dotadas de elementos de vedação, o que permite a imediata utilização das conexões, reduzindo notavelmente o tempo de instalação.
- 4 Todas as conexões retas podem ser montadas também com chave allentornando possível montagem das mesmas em espaços bem reduzidos.
- 5 Montagem ajustável com anel de segurança dentro. A durabilidade melhorada para a rotação e tração.

50000

RACCORDO DIRITTO MASCHIO "UNIVERSAL SHORT"

STRAIGHT MALE ADAPTOR "UNIVERSAL SHORT"

GERADE EINSCHRAUBVERSCHRAUBUNG KONISCH "UNIVERSAL SHORT"

RACCORD DROIT MÂLE, CONIQUE "UNIVERSAL SHORT"

RACOR RECTO MACHO CÓNICO "UNIVERSAL SHORT"

CONEXÃO RETA COM ROSCA "UNIVERSAL SHORT"

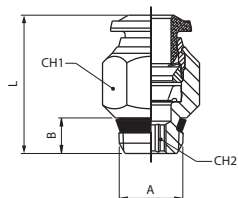

Code	Tube	A	B	L	CH1	CH2	Pack.
50000 00 001	4	1/8	5.5	18	11	3	10
50000 00 013	4	1/4	7	19	14	3	10
50000 00 011	5	1/8	5.5	20	11	4	10
50000 00 012	5	1/4	7	20	14	4	10
50000 00 002	6	1/8	5.5	21.5	13	4	10
50000 00 003	6	1/4	7	21	14	4	10
50000 00 014	6	3/8	7.5	23	17	4	10
50000 00 015	6	1/2	9	23.5	21	4	10
50000 00 004	8	1/8	5.5	24.5	14	5	10
50000 00 005	8	1/4	7	22	14	6	10
50000 00 006	8	3/8	7.5	23	17	6	10
50000 00 016	8	1/2	9	23.5	21	6	10
50000 00 007	10	1/4	7	28	17	7	10
50000 00 008	10	3/8	7.5	25.5	17	8	10
50000 00 017	10	1/2	9	26	21	8	10
50000 00 009	12	1/4	7	31.5	20	7	10
50000 00 010	12	3/8	7.5	29.5	20	9	10
50000 00 018	12	1/2	9	31.5	21	10	10
50000 00 019	14	3/8	7.5	32.5	21	9	10
50000 00 020	14	1/2	9	31.5	21	10	10
50000 00 021	16	3/8	7.5	35	23	10	10
50000 00 022	16	1/2	9	36	25	12	10

50010

RACCORDO DIRITTO MASCHIO ESAGONO INCASSATO

STRAIGHT MALE ADAPTOR WITH HEXAGON EMBEDDED

GERADE EINSCHRAUBVERSCHRAUBUNG MIT INNENSECHSKANT

RACCORD DROIT MÂLE, 6-PANS INTERIEUR

RACOR RECTO MACHO CÓNICO HEXÁGONO INTERIOR

CONEXÃO RETA COM SEXTAVADO INTERNO

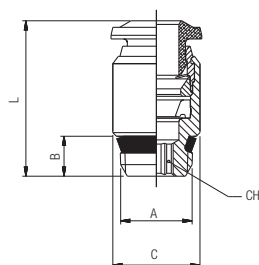

Code	Tube	A	B	C	L	CH	Pack.
50010 00 008	3	M5	3.6	8	19	2.5	10
50010 00 001	4	M5	3.6	9.5	19.5	2.5	10
50010 00 002	4	1/8	5.5	11	18	3	10
50010 00 009	4	M7x1	4.8	10	21	2.5	10
50010 00 007	6	M5	3.6	12	24.5	2.5	10
50010 00 003	6	1/8	5.5	12	21.5	4	10
50010 00 004	6	1/4	7	14	21	4	10
50010 00 005	8	1/8	5.5	14	25	5	10
50010 00 006	8	1/4	7	14	22.5	6	10

50020

RACCORDO DIRITTO MASCHIO CILINDRICO

STRAIGHT MALE ADAPTOR (PARALLEL)

GERADE EINSCHRAUBVERSCHRAUBUNG ZYLINDRISCH

RACCORD DROIT MÂLE, CYLINDRIQUE

RACOR RECTO MACHO CILÍNDRICO CON TÓRICA

CONEXÃO RETA COM ROSCA PARALELA

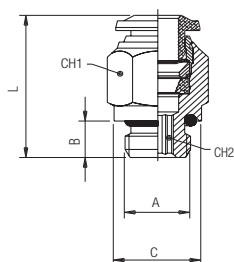

Code	Tube	A	B	C	L	CH1	CH2	Pack.
50020 00 021	3	M5	3.6	8	19	8	2	10
50020 00 034	4	M3	3	10	21	8	-	10
50020 00 001	4	M5	3.6	8	21	10	2	10
50020 00 002	4	1/8	5.4	13	20	10	3	10
50020 00 022	4	1/4	7.1	16	19.5	16	3	10
50020 00 041	4	3/8	8.1	20	18	20	3	10
50020 00 018	5	M5	3.6	8	23.5	12	2	10
50020 00 019	5	1/8	5.4	13	22	12	4	10
50020 00 036	5	1/4	7.1	16	22	12	4	10
50020 00 020	6	M5	3.6	10	24.5	13	2	10
50020 00 003	6	1/8	5.4	13	23.5	13	4	10
50020 00 004	6	1/4	7.1	16	23.5	13	4	10
50020 00 027	6	3/8	8.1	20	25	13	4	10
50020 00 028	6	1/2	9.6	25	27	13	4	10
50020 00 005	8	1/8	5.4	13	25	14	5	10
50020 00 006	8	1/4	7.1	16	23	14	6	10
50020 00 007	8	3/8	8.1	20	24	14	6	10
50020 00 029	8	1/2	9.6	25	26.5	14	6	10
50020 00 030	10	1/8	5.4	13	30	17	5	10
50020 00 008	10	1/4	7.1	16	30.5	17	6	10
50020 00 009	10	3/8	8.1	20	27.5	17	8	10
50020 00 031	10	1/2	9.6	25	27	17	8	10
50020 00 032	12	1/4	7.1	16	34.5	20	6	10
50020 00 011	12	3/8	8.1	20	34	20	8	10
50020 00 023	12	1/2	9.6	25	31	22	10	10
50020 00 024	14	3/8	8.1	20	35	21	10	10
50020 00 025	14	1/2	9.6	25	32	22	11	10
50020 00 042	16	3/8	8.1	20	36	23	10	10
50020 00 043	16	1/2	9.6	25	37	25	12	10
50020 00 046	4	M6x1	3.6	10	21	10	2.5	10
50020 00 033	4	M8x1	5.4	12	19	10	3	10
50020 00 037	6	M8x1	5.4	12	24.5	13	3	10
50020 00 038	6	M10x1	5.4	13	23	13	4	10
50020 00 012	6	M12x1	7.3	15	23.5	13	4	10
50020 00 013	6	M12x1.25	7.3	15	23.5	13	4	10
50020 00 014	6	M12x1.5	7.3	15	23.5	13	4	10
50020 00 039	8	M8x1	5.4	12	25.5	14	4	10
50020 00 040	8	M10x1	5.4	13	25.5	14	4	10
50020 00 017	8	M12x1.5	7.3	15	27.5	14	6	10

50030

RACCORDO DIRITTO FEMMINA

STRAIGHT FEMALE ADAPTOR

AUF SCHRAUBVERSCHRAUBUNG

RACCORD DROIT, TARAUE

RACOR RECTO HEMBRA

CONEXÃO RETA COM ROSCA FÊMEA

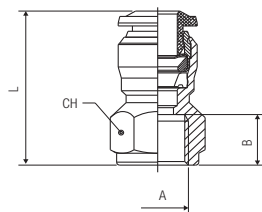

Code	Tube	A	B	L	CH	Pack.
50030 00 007	3	M5	5.5	18.5	9	10
50030 00 008	4	M5	5.5	21	11	10
50030 00 001	4	1/8	8.5	24	13	10
50030 00 009	4	1/4	11	27.5	16	10
50030 00 006	5	1/8	8.5	26.5	13	10
50030 00 002	6	1/8	8.5	26	13	10
50030 00 003	6	1/4	11	29.5	16	10
50030 00 004	8	1/8	8.5	27	15	10
50030 00 005	8	1/4	11	29.5	17	10
50030 00 010	8	3/8	12	32	19	10
50030 00 011	10	1/4	11	32	18	10
50030 00 012	10	3/8	12	33.5	19	10
50030 00 013	10	1/2	15	39	24	10
50030 00 014	12	3/8	12	36	21	10
50030 00 015	12	1/2	15	41	24	10
50030 00 016	16	3/8	12	40.5	24	10
50030 00 017	16	1/2	15	41.5	24	10

50040

RACCORDO DIRITTO INTERMEDIO

STRAIGHT CONNECTOR
 VERBINDUNGSVERSCHRAUBUNG
 RACCORD UNION DOUBLE
 RACOR RECTO INTERMEDIO
 CONEXÃO RETA TUBO-TUBO

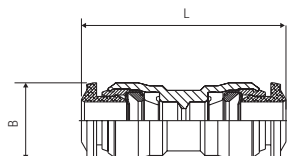

Code	Tube	Tube	L	B	Pack
50040 00 009	3	3	26	8.5	10
50040 00 001	4	4	30.5	10.5	10
50040 00 008	5	5	33	11.5	10
50040 00 002	6	4	32	12.5	10
50040 00 003	6	6	34	12.5	10
50040 00 004	8	6	35	14.5	10
50040 00 005	8	8	36	14.5	10
50040 00 011	10	8	40.5	17.5	10
50040 00 006	10	10	42	17.5	10
50040 00 012	12	10	45.5	20.5	10
50040 00 007	12	12	47	20.5	10
50040 00 010	14	14	49	21.5	10
50040 00 013	16	16	53.5	24	10

50050

RACCORDO DIRITTO INTERMEDIO DI ATTRAVERSAMENTO

BULKHEAD CONNECTOR
 SCHOTTVERSCHRAUBUNG
 TRAVERSÉE DE CLOISON
 RACOR RECTO INTERMEDIO PASATABIQUES
 CONEXÃO PASSA-MURO RETA TUBO-TUBO

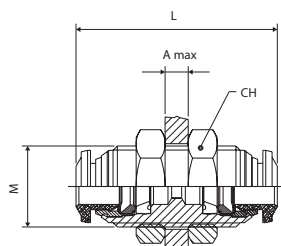

Code	Tube	M	L	CH	A _{max}	Pack.
50050 00 007	3	M10x1	26	14	5	10
50050 00 001	4	M12x1	31.5	17	7	10
50050 00 006	5	M14x1	33	17	7	10
50050 00 002	6	M14x1	35	17	9.5	10
50050 00 009	8-6	M16x1	37	19	10.5	10
50050 00 003	8	M16x1	37	19	10.5	10
50050 00 010	10-6	M20x1	43	24	11.5	10
50050 00 011	10-8	M20x1	43	24	12.5	10
50050 00 004	10	M20x1	43	24	12.5	10
50050 00 005	12	M22x1	48	26	16.5	10
50050 00 008	14	M23x1	49	27	16.5	10

50055

RACCORDO DIRITTO DI ATTRAVERSAMENTO FEMMINA

FEMALE BULKHEAD CONNECTOR
 SCHOTTVERSCHRAUBUNG INNENGEWINDE
 TRAVERSÉE DE CLOISON FEMELLE
 RACOR RECTO INTERMEDIO PASATABIQUES HEMBRA
 CONEXÃO PASSA-MURO RETA FEMEA

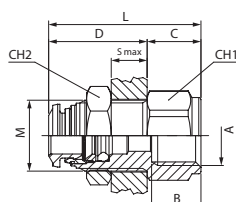

Code	Tube	A	B	M	S _{max}	CH1	CH2	C	D	L	Pack.
50055 00 001	4	1/8	8.5	M12X1	7	15	17	10	19	29	10
50055 00 002	6	1/8	8.5	M14X1	8	16	17	10	21	31	10
50055 00 003	6	1/4	11	M14X1	8	16	17	12	21	33	10
50055 00 004	8	1/8	8.5	M16X1	8	18	19	10	22	32	10
50055 00 005	8	1/4	11	M16X1	8	18	19	12	22	34	10
50055 00 006	10	3/8	12	M20X1	9.5	24	24	14	25.5	39.5	10
50055 00 007	12	3/8	12	M22X1	10.5	24	26	15	27.5	42.5	10
50055 00 008	12	1/2	15	M22X1	10.5	24	26	17	27.5	44.5	10

50100

RACCORDO A L MASCHIO CONICO

ELBOW MALE ADAPTOR (TAPER)

WINKELVERSCHRAUBUNG KONISCH (NICHT DREHBAR)

EQUERRE NON ORIENTABLE MÂLE, CONIQUE

RACOR A L MACHO CÔNICO

CONEXÃO MACHO EM "L" COM ROSCA CÔNICA

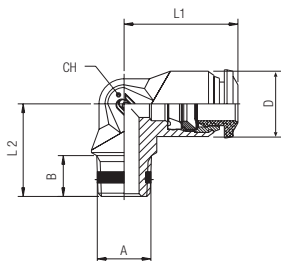

Code	Tube	A	B	L1	L2	CH	D	Pack.
50100 00 001	4	M5	5	17	15	9	10	10
50100 00 002	4	1/8	7.5	17	15.5	9	10	10
50100 00 010	5	M5	5	20	17	11	12.5	10
50100 00 011	5	1/8	7.5	20	17.5	11	12.5	10
50100 00 003	6	1/8	7.5	21	17.5	11	12.5	10
50100 00 012	6	1/4	11	21	21.5	11	12.5	10
50100 00 004	8	1/8	7.5	22.5	19	13	14	10
50100 00 005	8	1/4	11	22.5	21.5	13	14	10
50100 00 006	10	1/4	11	26.5	24.5	16	17	10
50100 00 007	10	3/8	11.5	26.5	24	16	17	10
50100 00 008	12	1/4	11	30.5	28	19	21.5	10
50100 00 009	12	3/8	11.5	30.5	28	19	21.5	10

50106

RACCORDO A L ORIENTABILE FEMMINA

ORIENTING ELBOW FEMALE ADAPTOR

AUFSCRAUB-WINKELSCHRAUBUNG (DREHBAR)

EQUERRE ORIENTABLE FEMELLE

RACOR A L ORIENTABLE HEMBRA

CONEXÃO EM "L" ORIENTÁVEL COM ROSCA FÊMEA

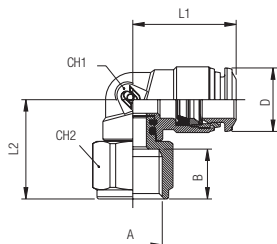

Code	Tube	A	B	L1	L2	CH1	CH2	D	Pack.
50106 00 001	4	1/8	8.5	18	19	9	13	10	10
50106 00 002	4	1/4	11	18	21.5	9	16	10	10
50106 00 003	6	1/8	8.5	21	20.5	11	13	12.5	10
50106 00 004	6	1/4	11	21	23	11	16	12.5	10
50106 00 005	8	1/8	8.5	22.5	22	12	13	14.5	10
50106 00 006	8	1/4	11	22.5	24.5	12	16	14.5	10
50106 00 007	8	3/8	12	22.5	24.5	12	13	14.5	10
50106 00 009	10	1/4	11	26.5	27	14	19	17	10
50106 00 010	10	3/8	12	26.5	30	14	19	17	10
50106 00 011	12	1/2	15	31.5	33.5	16	24	20	10

50111

RACCORDO A L ORIENTABILE MASCHIO "UNIVERSAL SHORT"

ORIENTING ELBOW MALE ADAPTOR "UNIVERSAL SHORT"

WINKELVERSCHRAUBUNG KONISCH (DREHBAR) "UNIVERSAL SHORT"

EQUERRE ORIENTABLE MÂLE, CONIQUE "UNIVERSAL SHORT"

RACOR A L ORIENTABLE MACHO CÔNICO "UNIVERSAL SHORT"

CONEXÃO MACHO EM "L" ORIENTÁVEL COM ROSCA "UNIVERSAL SHORT"

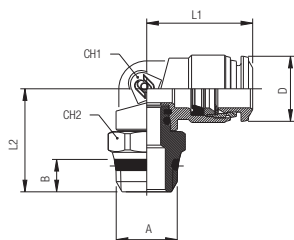

Code	Tube	A	B	L1	L2	CH	CH2	D	Pack.
50111 00 001	4	1/8	5.5	18	19.5	9	13	10	10
50111 00 002	4	1/4	7	18	21	9	15	10	10
50111 00 003	5	1/8	5.5	20	21.5	11	13	12.5	10
50111 00 004	6	1/8	5.5	21	21.5	11	13	12.5	10
50111 00 005	6	1/4	7	21	23	11	15	12.5	10
50111 00 006	8	1/8	5.5	22.5	24	12	13	14.5	10
50111 00 007	8	1/4	7	22.5	24	12	15	14.5	10
50111 00 008	8	3/8	7.5	22.5	24.5	12	17	14.5	10
50111 00 009	8	1/2	9	22.5	27	12	21	14.5	10
50111 00 010	10	1/4	7	26.5	28.5	14	16	17.5	10
50111 00 011	10	3/8	7.5	26.5	28	14	17	17.5	10
50111 00 012	10	1/2	9	26.5	29	14	21	17.5	10
50111 00 013	12	3/8	7.5	31.5	27.2	16	20	21.5	10
50111 00 014	12	1/2	9	31.5	29.7	16	21	21.5	10
50111 00 015	14	3/8	7.5	31.5	28.2	16	20	21.5	10
50111 00 016	14	1/2	9	31.5	30.7	16	21	21.5	10
50111 00 017	16	3/8	7.5	33	41.5	19	25	24	10
50111 00 018	16	1/2	9	33	43	19	25	24	10

50116

RACCORDO A L ORIENTABILE MASCHIO CILINDRICO

ORIENTING ELBOW MALE ADAPTOR (PARALLEL)

WINKELVERSCHRAUBUNG ZYLINDRISCH (DREHBAR)

EQUERRE ORIENTABLE MÂLE, CYLINDRIQUE

RACOR A L ORIENTABLE MACHO CILÍNDRICO CON TÓRICA

CONEXÃO MACHO EM "L" ORIENTÁVEL COM ROSCA PARALELA

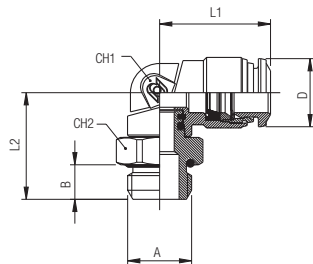

Code	Tube	A	B	L1	L2	CH1	CH2	D	Pack.
50116 00 001	3	M5	3.6	16.5	17.5	9	8	10	10
50116 00 002	4	M5	3.6	18	17.5	9	8	10	10
50116 00 003	4	1/8	5.4	18	18	9	13	10	10
50116 00 004	4	1/4	7.1	18	18	9	16	10	10
50116 00 005	5	M5	3.6	20	20	11	11	12.5	10
50116 00 006	5	1/8	5.4	20	20	11	13	12.5	10
50116 00 007	6	M5	3.6	21	20	11	11	12.5	10
50116 00 008	6	1/8	5.4	21	20	11	13	12.5	10
50116 00 009	6	1/4	7.1	21	21.5	11	16	12.5	10
50116 00 030	6	3/8	8.1	21.5	21.5	11	16	12.5	10
50116 00 010	8	1/8	5.4	22.5	22.5	12	13	14.5	10
50116 00 011	8	1/4	7.1	22.5	23	12	16	14.5	10
50116 00 012	8	3/8	8.1	22.5	25	12	20	14.5	10
50116 00 013	8	1/2	9.6	22.5	26.5	12	25	14.5	10
50116 00 014	10	1/4	7.1	26.5	27.5	14	16	17.5	10
50116 00 015	10	3/8	8.1	26.5	27	14	20	17.5	10
50116 00 016	10	1/2	9.6	26.5	28.5	14	25	17.5	10
50116 00 025	12	1/4	7.1	30.5	27.8	16	16	21.5	10
50116 00 017	12	3/8	8.1	31.5	27.3	16	20	21.5	10
50116 00 018	12	1/2	9.6	31.5	28.8	16	25	21.5	10
50116 00 019	14	3/8	8.1	31.5	28.3	16	20	21.5	10
50116 00 020	14	1/2	9.6	31.5	29.8	16	25	21.5	10
50116 00 031	16	3/8	8.1	33	40	19	25	24	10
50116 00 032	16	1/2	9.6	33	41.5	19	25	24	10
50116 00 026	4	M6x1	3.6	17.5	18	9	8	10	10
50116 00 027	4	M8x1	5.4	17.5	18	9	12	10	10
50116 00 028	6	M10x1	5.4	21	21.5	11	13	12	10
50116 00 021	6	M12x1	7.3	20	22	11	16	12.5	10
50116 00 022	6	M12x1.25	7.3	20	22	11	16	12.5	10
50116 00 023	6	M12x1.5	7.3	20	22	11	16	12.5	10
50116 00 024	8	M12x1.5	7.3	22.5	23.5	12	16	14.5	10

50121

RACCORDO A L ORIENTABILE PROLUNGATO MASCHIO "UNIVERSAL SHORT"

EXTENDED ORIENTING ELBOW MALE ADAPTOR "UNIVERSAL SHORT"

VERLÄNGERTE WINKELVERSCHRAUBUNG KONISCH (DREHBAR) "UNIVERSAL SHORT"

EQUERRE PROLONGÉE ORIENTABLE MÂLE, CONIQUE "UNIVERSAL SHORT"

RACOR A L ORIENTABLE PROLONGADO MACHO CÓNICO "UNIVERSAL SHORT"

CONEXÃO EM "L" PROLONGADO ORIENTÁVEL COM ROSCA MACHO "UNIVERSAL SHORT"

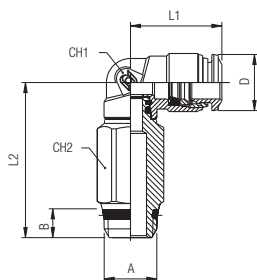

Code	Tube	A	B	L1	L2	CH1	CH2	D	Pack.
50121 00 001	4	1/8	5.5	18	31.5	9	12	10	10
50121 00 002	4	1/4	7	18	33	9	15	10	10
50121 00 003	5	1/8	5.5	20	36	11	12	12.5	10
50121 00 004	6	1/8	5.5	21	36	11	12	12.5	10
50121 00 005	6	1/4	7	21	37.5	11	15	12.5	10
50121 00 006	8	1/8	5.5	22.5	40.5	12	12	14.5	10
50121 00 007	8	1/4	7	22.5	40.5	12	15	14.5	10
50121 00 008	8	3/8	7.5	22.5	41	12	16	14.5	10
50121 00 009	10	1/4	7	26.5	48	14	15	17.5	10
50121 00 010	10	3/8	7.5	26.5	48	14	17	17.5	10

50126

RACCORDO A L ORIENTABILE PROLUNGATO MASCHIO CILINDRICO

EXTENDED ORIENTING ELBOW MALE ADAPTOR (PARALLEL)

VERLÄNGERTE WINKELVERSCHRAUBUNG ZYLINDRISCH (DREHBAR)

EQUERRE PROLONGÉE ORIENTABLE MÂLE, CYLINDRIQUE

RACOR A L ORIENTABLE PROLONGADO MACHO CILÍNDRICO CON TÓRICA

CONEXÃO EM "L" PROLONGADO ORIENTÁVEL COM ROSCA MACHO PARALELA

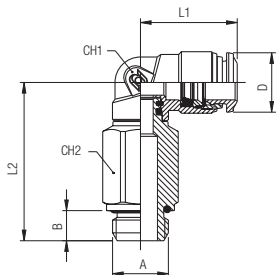

Code	Tube	A	B	L1	L2	CH1	CH2	D	Pack.
50126 00 001	4	1/8	5.4	18	30	9	12	10	10
50126 00 002	4	1/4	7.1	18	32	9	15	10	10
50126 00 003	5	1/8	5.4	20	34.5	11	12	12.5	10
50126 00 004	6	1/8	5.4	21	34.5	11	12	12.5	10
50126 00 005	6	1/4	7.1	21	36	11	15	12.5	10
50126 00 006	8	1/8	5.4	23	39	12	12	14.5	10
50126 00 007	8	1/4	7.1	22.5	39.5	12	15	14.5	10
50126 00 008	8	3/8	8.1	22.5	41.5	12	18	14.5	10
50126 00 009	10	1/4	7.1	26.5	46.6	14	16	17.5	10
50126 00 010	10	3/8	8.1	26.5	46.1	14	18	17.5	10

50130

RACCORDO A L INTERMEDIO

ELBOW CONNECTOR

WINKELVERSCHRAUBUNG

RACCORD EQUERRE

RACOR A L INTERMEDIO

CONEXÃO EM "L" TUBO-TUBO

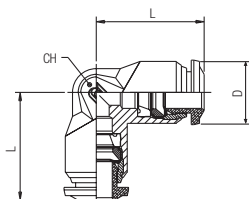

Code	Tube	L	CH	D	Pack.
50130 00 007	3	17	9	10	10
50130 00 001	4	17	9	10	10
50130 00 006	5	20	11	12.5	10
50130 00 002	6	21	11	12.5	10
50130 00 003	8	22.5	13	14	10
50130 00 004	10	26.5	16	17	10
50130 00 005	12	30.5	19	21.5	10
50130 00 008	14	32.5	19	21.5	10
50130 00 009	16	33	19	24	10

50200

RACCORDO A T MASCHIO CONICO

TEE MALE ADAPTOR (TAPER) - CENTRE LEG

T-EINSCHRAUBVERSCHRAUBUNG KONISCH (NICHT DREHBAR)

TÉ NON ORIENTABLE À PIQUAGE MÂLE CENTRAL, CONIQUE

RACOR A T MACHO CENTRAL CÓNICO

CONEXÃO EM "T" CENTRAL COM ROSCA MACHO CÔNICA

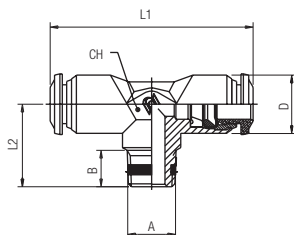

Code	Tube	A	B	L1	L2	CH	D	Pack.
50200 00 001	4	M5	5	34	15	9	10	10
50200 00 002	4	1/8	7.5	34	15.5	9	10	10
50200 00 010	5	1/8	7.5	40	17.5	11	12.5	10
50200 00 003	6	1/8	7.5	42	17.5	11	12.5	10
50200 00 004	8	1/8	7.5	45	19	13	14	10
50200 00 005	8	1/4	11	45	21.5	13	14	10
50200 00 006	10	1/4	11	53	24.5	16	17	10
50200 00 007	10	3/8	11.5	53	24	16	17	10
50200 00 008	12	1/4	11	61	28	19	21.5	10
50200 00 009	12	3/8	11.5	61	28	19	21.5	10

50211

RACCORDO A T ORIENTABILE MASCHIO "UNIVERSAL SHORT"

ORIENTING TEE MALE ADAPTOR "UNIVERSAL SHORT" - CENTRE LEG
 T-EINSCHRAUBVERSCHRAUBUNG KONISCH (DREHBAR) "UNIVERSAL SHORT"
 TÉ ORIENTABLE À PIQUAGE MÂLE CENTRAL, CONIQUE "UNIVERSAL SHORT"
 RACOR A T ORIENTABLE MACHO CENTRAL CÓNICO "UNIVERSAL SHORT"
 CONEXÃO EM "T" CENTRAL ORIENTÁVEL COM ROSCA MACHO "UNIVERSAL SHORT"

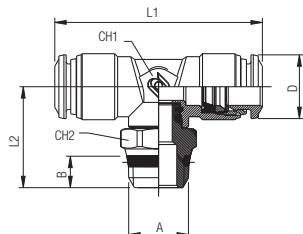

Code	Tube	A	B	L1	L2	CH1	CH2	D	Pack.
50211 00 001	4	1/8	5.5	34	20	9	13	10	10
50211 00 002	4	1/4	7	34	21.5	9	15	10	10
50211 00 003	5	1/8	5.5	40	22	11	13	12.5	10
50211 00 004	6	1/8	5.5	42	22	11	13	12.5	10
50211 00 005	6	1/4	7	42	23.5	11	15	12.5	10
50211 00 006	8	1/8	5.5	45	25.5	13	13	14.5	10
50211 00 007	8	1/4	7	45	25.5	13	15	14.5	10
50211 00 008	8	3/8	7.5	45	26	13	17	14.5	10
50211 00 009	8	1/2	9	45	28.5	13	21	14.5	10
50211 00 010	10	1/4	7	53	28.5	14	16	17.5	10
50211 00 011	10	3/8	7.5	53	28	14	17	17.5	10
50211 00 012	10	1/2	9	53	29	14	21	17.5	10
50211 00 013	12	3/8	7.5	62.6	29.1	16	20	21.5	10
50211 00 014	12	1/2	9	62.6	31.6	16	21	21.5	10
50211 00 015	14	3/8	7.5	62.6	29.1	16	20	21.5	10
50211 00 016	14	1/2	9	62.6	31.6	16	21	21.5	10
50211 00 017	16	3/8	7.5	65.5	40	19	25	24	10
50211 00 018	16	1/2	9	65.5	41.5	19	25	24	10

50216

RACCORDO A T ORIENTABILE MASCHIO CILINDRICO

ORIENTING TEE MALE ADAPTOR (PARALLEL) - CENTRE LEG
 T-EINSCHRAUBVERSCHRAUBUNG ZYLINDRISCH (DREHBAR)
 TÉ ORIENTABLE À PIQUAGE MÂLE CENTRAL, CYLINDRIQUE
 RACOR A T ORIENTABLE MACHO CENTRAL CILÍNDRICO CON TÓRICA
 CONEXÃO EM "T" CENTRAL ORIENTÁVEL COM ROSCA MACHO PARALELA

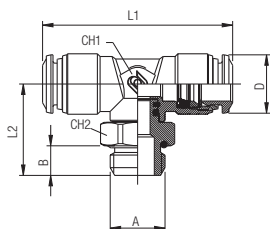

Code	Tube	A	B	L1	L2	CH1	CH2	D	Pack.
50216 00 001	3	M5	3.6	33	17	9	8	10	10
50216 00 002	4	M5	3.6	34	18	9	8	10	10
50216 00 003	4	1/8	5.4	34	18.5	9	13	10	10
50216 00 004	4	1/4	7.1	34	20	9	16	10	10
50216 00 005	5	M5	3.6	40	20.5	11	11	12.5	10
50216 00 006	5	1/8	5.4	40	20.5	11	13	12.5	10
50216 00 007	6	M5	3.6	42	20.5	11	11	12.5	10
50216 00 008	6	1/8	5.4	42	20.5	11	13	12.5	10
50216 00 009	6	1/4	7.1	42	22	11	16	12.5	10
50216 00 010	8	1/8	5.4	45	23.5	13	13	14.5	10
50216 00 011	8	1/4	7.1	45	24	13	16	14.5	10
50216 00 012	8	3/8	8.1	45	26	13	20	14.5	10
50216 00 013	8	1/2	9.6	45	27.5	13	25	14.5	10
50216 00 014	10	1/4	7.1	53	27.1	14	16	17.5	10
50216 00 015	10	3/8	8.1	53	26.6	14	20	17.5	10
50216 00 016	10	1/2	9.6	53	28.1	14	25	17.5	10
50216 00 017	12	3/8	8.1	62.5	29.1	16	20	21.5	10
50216 00 018	12	1/2	9.6	62.5	31.6	16	25	21.5	10
50216 00 019	14	3/8	8.1	62.5	29.1	16	20	21.5	10
50216 00 020	14	1/2	9.6	62.5	31.6	16	25	21.5	10
50216 00 025	16	3/8	8.1	65.5	40	19	25	24	10
50216 00 026	16	1/2	9.6	65.5	41.5	19	25	24	10
50216 00 021	6	M12x1	7.3	42	22	11	16	12.5	10
50216 00 022	6	M12x1.25	7.3	42	22	11	16	12.5	10
50216 00 023	6	M12x1.5	7.3	42	22	11	16	12.5	10

50223

RACCORDO A T ORIENTABILE MASCHIO LATERALE "UNIVERSAL SHORT"

ORIENTING TEE MALE ADAPTOR "UNIVERSAL SHORT" OFF - SET LEG
 L-EINSCHRAUBVERSCHRAUBUNG KONISCH (DREHBAR) "UNIVERSAL SHORT"
 TÉ ORIENTABLE À PIQUAGE LATÉRAL, CONIQUE "UNIVERSAL SHORT"
 RACOR A T ORIENTABLE MACHO LATERAL CÓNICO "UNIVERSAL SHORT"
 CONEXÃO EM "T" LATERAL ORIENTÁVEL COM ROSCA MACHO "UNIVERSAL SHORT"

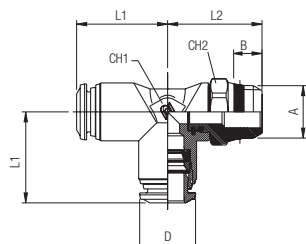

Code	Tube	A	B	L1	L2	CH1	CH2	D	Pack.
50223 00 001	4	1/8	5.5	17	20	9	13	10	10
50223 00 002	4	1/4	7	17	21.5	9	15	10	10
50223 00 003	5	1/8	5.5	20	22	11	13	12.5	10
50223 00 004	6	1/8	5.5	21	22	11	13	12.5	10
50223 00 005	6	1/4	7	21	23.5	11	15	12.5	10
50223 00 006	8	1/8	5.5	22.5	25	13	13	14.5	10
50223 00 007	8	1/4	7	22.5	25	13	15	14.5	10
50223 00 008	8	3/8	7.5	22.5	24.5	13	17	14.5	10
50223 00 009	8	1/2	9	22.5	28	13	21	14.5	10
50223 00 010	10	1/4	7	26.5	28.5	14	16	17.5	10
50223 00 011	10	3/8	7.5	26.5	28	14	17	17.5	10
50223 00 012	10	1/2	9	26.5	29	14	21	17.5	10
50223 00 013	12	3/8	7.5	31.5	29.1	16	20	21.5	10
50223 00 014	12	1/2	9	31.5	31.6	16	21	21.5	10

50226

RACCORDO A T ORIENTABILE MASCHIO LATERALE CILINDRICO

ORIENTING TEE MALE ADAPTOR (PARALLEL) OFF - SET LEG

L-EINSCHRAUBVERSCHRAUBUNG ZYLINDRISCH (DREHBAR)

TÉ ORIENTABLE À PIQUAGE LATÉRAL, CYLINDRIQUE

RACOR A T ORIENTABLE MACHO LATERAL CILÍNDRICO CON TÓRICA

CONEXÃO EM "T" LATERAL ORIENTÁVEL COM ROSCA MACHO PARALELA

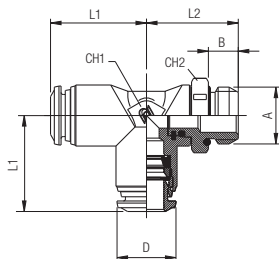

Code	Tube	A	B	L1	L2	CH1	CH2	D	Pack.
50226 00 001	3	M5	3.6	16.5	17	9	8	10	10
50226 00 002	4	M5	3.6	17	18	9	8	10	10
50226 00 003	4	1/8	5.4	17	18.5	9	13	10	10
50226 00 004	4	1/4	7.1	17	20	9	16	10	10
50226 00 005	5	M5	3.6	20	20.5	11	11	12.5	10
50226 00 006	5	1/8	5.4	20	20.5	11	13	12.5	10
50226 00 007	6	M5	3.6	21	20.5	11	11	12.5	10
50226 00 008	6	1/8	5.4	21	20.5	11	13	12.5	10
50226 00 009	6	1/4	7.1	21	22	11	16	12.5	10
50226 00 010	8	1/8	5.4	22.5	22.5	13	13	14.5	10
50226 00 011	8	1/4	7.1	22.5	24	13	16	14.5	10
50226 00 012	8	3/8	8.1	22.5	26	13	20	14.5	10
50226 00 013	8	1/2	9.6	22.5	27.5	13	25	14.5	10
50226 00 014	10	1/4	7.1	26.5	27.1	14	16	17.5	10
50226 00 015	10	3/8	8.1	26.5	26.6	14	20	17.5	10
50226 00 016	10	1/2	9.6	26.5	28.1	14	25	17.5	10
50226 00 017	12	3/8	8.1	31.5	29.1	16	20	21.5	10
50226 00 018	12	1/2	9.6	31.5	31.6	16	25	21.5	10
50226 00 021	6	M12x1	7.3	21	22	11	16	12.5	10
50226 00 022	6	M12x1.25	7.3	21	22	11	16	12.5	10
50226 00 023	6	M12x1.5	7.3	21	22	11	16	12.5	10

50230

RACCORDO A T INTERMEDIO

TEE CONNECTOR

T-ANSCHLUSS

RACCORD TÉ

RACOR A T INTERMEDIO

CONEXÃO EM "T" TUBO-TUBO

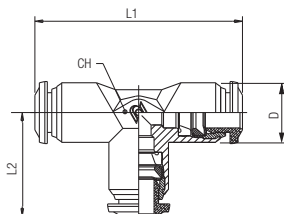

Code	Tube	L1	L2	CH	D	Pack.
50230 00 007	3	34	17	9	10	10
50230 00 001	4	34	17	9	10	10
50230 00 006	5	40	20	11	12.5	10
50230 00 002	6	42	21	11	12.5	10
50230 00 003	8	45	22.5	13	14	10
50230 00 004	10	53	26.5	16	17	10
50230 00 005	12	61	30.5	19	21.5	10
50230 00 008	14	65.5	32.5	19	21.5	10
50230 00 010	16	65.5	33	19	24	10

50310

RACCORDO A Y INTERMEDIO

Y CONNECTOR

Y-ANSCHLUSS

RACCORD Y SIMPLE

RACOR A Y INTERMEDIO

CONEXÃO EM "Y" TUBO-TUBO

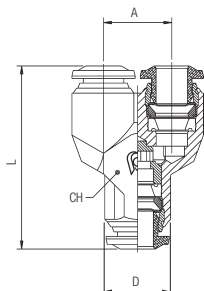

Code	Tube	A	L	CH	D	Pack.
50310 00 007	3	10	29	11	10	10
50310 00 001	4	11	32	11	10	10
50310 00 004	5	13.5	35	13	12.5	10
50310 00 002	6	13.5	36.5	13	12.5	10
50310 00 003	8	15.5	41	15	14	10
50310 00 008	10	18.5	48	18	17	10

50326

RACCORDO A Y ORIENTABILE MASCHIO CILINDRICO

Y CONNECTOR MALE ADAPTOR (PARALLEL)

Y-ANSCHLUSS ZYLINDRISCH (DREHBAR)

RACCORD Y SIMPLE MÂLE, CYLINDRIQUE

RACOR A Y ORIENTABLE MACHO CILÍNDRICO CON TÓRICA

CONEXÃO MACHO EM "Y" ORIENTÁVEL COM ROSCA PARALELA

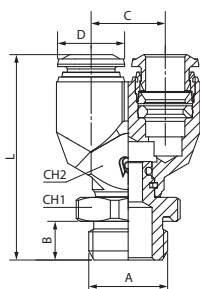

Code	Tube	A	B	C	L	CH1	CH2	D	Pack.
50326 00 003	4	1/8	5.4	11	32.5	13	11	10	10
50326 00 008	6	1/8	5.4	13.5	37	13	13	12.5	10
50326 00 009	6	1/4	7.1	13.5	38.5	16	13	12.5	10
50326 00 010	8	1/8	5.4	15.5	40.5	13	15	14	10
50326 00 011	8	1/4	7.1	15.5	41	16	15	14	10
50326 00 012	8	3/8	8.1	15.5	43	20	15	14	10

50500

ANELLO ORIENTABILE A L

SINGLE BANJO BODY

RINGANSCHLUSS

CORPS SIMPLE POUR BANJO

ANILLO ORIENTABLE SIMPLE

ANEL ORIENTÁVEL EM "L"

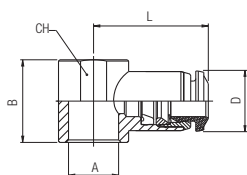

Code	Tube	A	B	L	CH	D	Pack.
50500 00 019	3	M5	12.5	19	-	10	10
50500 00 020	3	M6	12.5	19	-	10	10
50500 00 001	4	M5	12.5	19	-	10	10
50500 00 002	4	M6	12.5	19	-	10	10
50500 00 003	4	1/8	15	21	14	10	10
50500 00 013	5	M5	12.5	20	-	12.5	10
50500 00 017	5	M6	12.5	20	-	12.5	10
50500 00 014	5	1/8	15	21.5	14	12.5	10
50500 00 015	5	1/4	17	24.5	18	12.5	10
50500 00 016	6	M5	12.5	20.5	-	12.5	10
50500 00 018	6	M6	12.5	20.5	-	12.5	10
50500 00 004	6	1/8	15	22	14	12.5	10
50500 00 005	6	1/4	17	25	18	12.5	10
50500 00 006	8	1/8	15	24	14	14	10
50500 00 007	8	1/4	17	26	18	14	10
50500 00 008	8	3/8	20	28	21	14	10
50500 00 009	10	1/4	17	29	18	17	10
50500 00 010	10	3/8	20	30.5	21	17	10
50500 00 012	12	3/8	20	32.5	21	21.5	10
50500 00 021	12	1/2	24	35	25	21.5	10
50500 00 022	14	1/2	24	35.5	25	21.5	10

50510

ANELLO ORIENTABILE A T

DOUBLE BANJO BODY

DOPPELTER RINGANSCHLUSS

CORPS DOUBLE POUR BANJO

ANILLO ORIENTABLE DOBLE

ANEL ORIENTÁVEL EM "T"

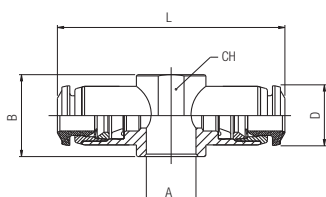

Code	Tube	A	B	L	CH	D	Pack.
50510 00 001	4	M5	12.5	38	-	10	10
50510 00 002	4	M6	12.5	38	-	10	10
50510 00 003	4	1/8	15	42	14	10	10
50510 00 008	5	1/8	15	43	14	12.5	10
50510 00 009	5	1/4	17	49	18	12.5	10
50510 00 004	6	1/8	15	44	14	12.5	10
50510 00 005	6	1/4	17	50	18	12.5	10
50510 00 006	8	1/8	15	48	14	14	10
50510 00 007	8	1/4	17	52	18	14	10

50550

RACCORDO ORIENTABILE A L

ORIENTING SINGLE BANJO BODY MALE
WINKELSCHWENKVERSCHRAUBUNG (DREHBAR)
EQUERRE BANJO MÂLE, ORIENTABLE
RACOR ORIENTABLE SIMPLE CON TÓRICA
CONEXÃO TIPO BANJO EM "L"

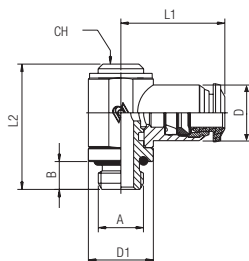

Code	Tube	A	B	L1	L2	CH	D1	D	Pack.
50550 00 001	4	M5	3.6	19	24.5	-	CH8	10	10
50550 00 002	4	1/8	5.4	21	28	5	14	10	10
50550 00 012	5	M5	3.6	20	24.5	-	CH8	12.5	10
50550 00 013	5	1/8	5.4	21.5	28	5	14	12.5	10
50550 00 014	5	1/4	7.1	24.5	31	6	17	12.5	10
50550 00 015	6	M5	3.6	20.5	24.5	-	CH8	12.5	10
50550 00 003	6	1/8	5.4	22.5	28	5	14	12.5	10
50550 00 004	6	1/4	7.1	25	31	6	17	12.5	10
50550 00 005	8	1/8	5.4	24	28	5	14	14	10
50550 00 006	8	1/4	7.1	26	31	6	17	14	10
50550 00 007	8	3/8	8.1	28	35.5	7	20	14	10
50550 00 008	10	1/4	7.1	29	31	6	17	17	10
50550 00 009	10	3/8	8.1	30.5	35.5	7	20	17	10
50550 00 011	12	3/8	8.1	32.5	35.5	7	20	21.5	10

50560

RACCORDO ORIENTABILE A T

ORIENTING DOUBLE BANJO BODY MALE
T-SCHWENKVERSCHRAUBUNG (DREHBAR)
TÉ BANJO MÂLE, ORIENTABLE
RACOR ORIENTABLE DOBLE CON TÓRICA
CONEXÃO TIPO BANJO EM "T"

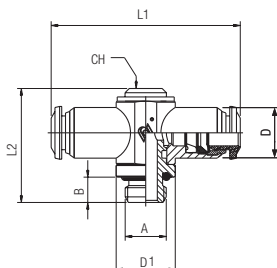

Code	Tube	A	B	L1	L2	D1	CH	D	Pack.
50560 00 002	4	1/8	5.4	42	27	14	5	10	10
50560 00 008	5	1/8	5.4	43	27	14	5	12.5	10
50560 00 009	5	1/4	7.1	49	31	17	6	12.5	10
50560 00 003	6	1/8	5.4	45	27	14	5	12.5	10
50560 00 004	6	1/4	7.1	50	31	17	6	12.5	10
50560 00 005	8	1/8	5.4	48	27	14	5	14	10
50560 00 006	8	1/4	7.1	52	31	17	6	14	10

51410

VITE CAVA SINGOLA

BANJO SCREW SINGLE
EINFACHE HOHLSCHRAUBE
VIS POUR BANJO SIMPLE
TORNILLO SIMPLE
HASTE PARA CONEXÃO BANJO COM 1 CAVIDADE

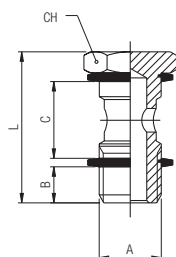

Code	A	B	C	L	CH	Pack.
51410 00 011	M5	4	12.5	22	8	10
51410 00 012	M6	5	12.5	23	8	10
51410 00 013	1/8	6	15	28	14	10
51410 00 014	1/4	8	17	32	17	10
51410 00 015	3/8	9	20	36	19	10
51410 00 016	1/2	10	24	42	24	10
51410 00 017	*M12x1.5	8	17	32	17	10

Questo articolo viene fornito completo di rondelle in PA66 (ART. 1610).
This item will be supplied with the PA66 washers (ART. 1610).
Dieser artikel wird mit dichtringen aus PA66 (ART. 1610) Mitgeliefert.
Livré avec joints en PA66 (ART. 1610).
Este artículo viene completo de arandelas en nylon (ART. 1610).
Este item vem acompanhado de arruelas em PA66 (CÓD. 1610).

* Con questa vite utilizzare gli anelli orientabili da 1/4.
* With this banjo SCREW using 1/4 orienting banjo body.
* Bei dieser größe können dichtringe für 1/4 eingesetzt werden.
* Compatible avec joint 1/4.
* Con este tornillo utilizar el anillo orientable de 1/4.
* Com esta haste para banjo utilizar os anéis orientáveis de 1/4.

51420

VITE CAVA DOPPIA

BANJO SCREW DOUBLE
 DOPPELTE HOHLSCHRAUBE
 VIS POUR BANJO DOUBLE
 TORNILLO DOBLE
 HASTE PARA CONEXÃO BANJO COM 2 CAVIDADES

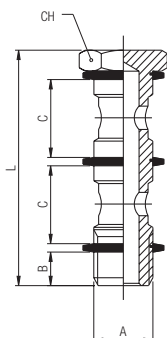

Code	A	B	C	L	CH	Pack.
51420 00 011	1/8	6	15	44.5	14	10
51420 00 012	1/4	8	17	50.5	17	10
51420 00 013	3/8	9	20	58	19	10
51420 00 014	1/2	10	24	68	24	10
51420 00 015	*M12x1.5	8	17	50.5	17	10

Questo articolo viene fornito completo di rondelle in PA66 (ART. 1610).
 This item will be supplied with the PA66 washers (ART. 1610).
 Dieser artikel wird mit dichtringen aus PA66 (ART. 1610) Mitgeliefert.
 Livré avec joints en PA66 (ART. 1610).
 Este artículo viene completo de arandelas en nylon (ART. 1610).
 Este item vem acompanhado de arruelas em PA66 (CÓD. 1610).

- * Con questa vite utilizzare gli anelli orientabili da 1/4.
- * With this banjo SCREW using 1/4 orienting banjo body.
- * Bei dieser größe können dichtringe für 1/4 eingesetzt werden.
- * Compatible avec joint 1/4.
- * Con este tornillo utilizar el anillo orientable de 1/4.
- * Com esta haste para banjo utilizar os anéis orientáveis de 1/4.

51430

VITE CAVA TRIPLA

BANJO SCREW TRIPLE
 DREIFACH HOHLSCHRAUBE
 VIS POUR BANJO TRIPLE
 TORNILLO TRIPLE
 HASTE PARA CONEXÃO BANJO COM 3 CAVIDADES

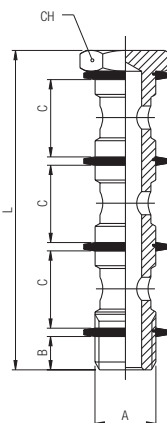

Code	A	B	C	L	CH	Pack.
51430 00 011	1/8	6	15	61	14	10
51430 00 012	1/4	8	17	69	17	10
51430 00 013	3/8	9	20	80	19	10
51430 00 014	1/2	10	24	94	24	10

Questo articolo viene fornito completo di rondelle in PA66 (ART. 1610).
 This item will be supplied with the PA66 washers (ART. 1610).
 Dieser artikel wird mit dichtringen aus PA66 (ART. 1610) Mitgeliefert.
 Livré avec joints en PA66 (ART. 1610).
 Este artículo viene completo de arandelas en nylon (ART. 1610).
 Este item vem acompanhado de arruelas em PA66 (cód. 1610).

51440

VITE CAVA SINGOLA MASCHIO - FEMMINA

MALE - FEMALE BANJO SCREW SINGLE
 AUF SCHRAUBHOHLSCHRAUBE MIT INNENGEWINDE
 VIS CREUSE TARAUDÉE POUR BANJO SIMPLE
 TORNILLO SIMPLE MACHO - HEMBRA
 HASTE PARA CONEXÃO BANJO COM 1 CAVIDADE MACHO - FÊMEA

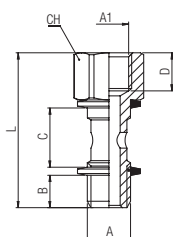

Code	A	A1	B	C	D	L	CH	Pack.
51440 00 001	1/8	1/8	6	15	8.5	34.5	14	10
51440 00 002	1/4	1/4	8	17	11	40.5	17	10
51440 00 003	3/8	3/8	9	20	12	45.5	19	10

Questo articolo viene fornito completo di rondelle in PA66 (ART. 1610).
 This item will be supplied with the PA66 washers (ART. 1610).
 Dieser artikel wird mit dichtringen aus PA66 (ART. 1610) Mitgeliefert.
 Livré avec joints en PA66 (ART. 1610).
 Este artículo viene completo de arandelas en nylon (ART. 1610).
 Este item vem acompanhado de arruelas em PA66 (CÓD. 1610).

50600

ADATTATORE MASCHIO CILINDRICO

MALE ADAPTOR PARALLEL

EINSCHRAUBSTECKERVERSCHRAUBUNG ZYLINDRISCH

ADAPTATEUR ENCLIQUETABLE MÂLE, CYLINDRIQUE

ADAPTADOR MACHO CILÍNDRICO CON TÓRICA

ADAPTADOR MACHO COM ROSCA PARALELA

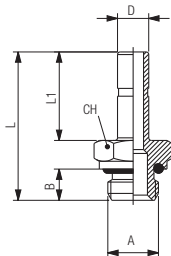

Code	D	A	B	L	L1	CH	Pack.
50600 00 001	4	M5	3.6	24	15	8	10
50600 00 002	4	1/8	5.4	26.5	15	13	10
50600 00 012	5	M5	3.6	26	17	8	10
50600 00 013	5	1/8	5.4	28.5	17	13	10
50600 00 014	5	1/4	7.1	31	17	16	10
50600 00 015	6	M5	3.6	26	17	8	10
50600 00 003	6	1/8	5.4	28.5	17	13	10
50600 00 004	6	1/4	7.1	31	17	16	10
50600 00 005	8	1/8	5.4	29.5	18	13	10
50600 00 006	8	1/4	7.1	32	18	16	10
50600 00 007	8	3/8	8.1	33.5	18	20	10
50600 00 016	10	1/8	5.4	33.5	22	13	10
50600 00 008	10	1/4	7.1	36	22	16	10
50600 00 009	10	3/8	8.1	37.5	22	20	10
50600 00 017	10	1/2	9.6	39.5	22	24	10
50600 00 010	12	1/4	7.1	38.5	24.5	16	10
50600 00 011	12	3/8	8.1	40	24.5	20	10
50600 00 018	14	1/2	9.6	44	26.5	24	10

50610

TAPPO IN POLIAMIDE

POLYAMIDE PLUG

VERSCHLUSSZAPFEN POLYAMID

BOUCHON EN POLYAMIDE

TAPÓN EN POLIAMIDA

TAMPÃO EM POLIAMIDA

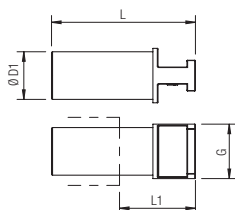

Code	ØD1	G	L	L1	Pack.
50610 00 31 X0 RO	3	5	30.5	18	10
50610 00 31 X1 RO	4	6	29.5	15.5	10
50610 00 31 X3 RO	5	7	33.5	18	10
50610 00 31 X4 RO	6	8	32	15.5	10
50610 00 31 X7 RO	8	10	35.5	19.5	10
50610 00 31 X9 RO	10	12	40	19.5	10
50610 00 31 Y1 RO	12	14	41.5	20	10
50610 00 31 Y3 RO	14	16	42	19.5	10
50610 00 31 Y5 RO	16	18	45	21	10

50615

COPERTURA COLORATA PER SPINTORE

COLORLED RELEASE BOTTON COVERS

ABDECKRINGE MEHRFARBIG

CACHE POUSSOIR

FUNDAS PARA ANILLOS COLORADOS

CAPA COLORIDA PARA ANILHA DE LIBERACAO



Code	Colore Color Farbe Couleur Color Cor					Tube	Pack.
	BN	BL	GI	RO	VE		
50615 00 A7 X1	BN	BL	GI	RO	VE	4	10
50615 00 A7 X4	BN	BL	GI	RO	VE	6	10
50615 00 A7 X7	BN	BL	GI	RO	VE	8	10
50615 00 A7 X9	BN	BL	GI	RO	VE	10	10
50615 00 A7 Y1	BN	BL	GI	RO	VE	12	10
50615 00 A7 Y3	BN	BL	GI	RO	VE	14	10

50625

GIUNZIONE DOPPIA

DOUBLE JOINT
DOPPELSTECKER
JONCTION DOUBLE
UNIÓN DOBLE
JUNÇÃO DUPLA

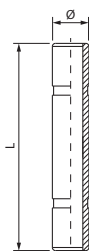

Code	Tube (Ø)	L	Pack.
50625 00 01 X1 NB	4	31	10
50625 00 01 X3 NB	5	33	10
50625 00 01 X4 NB	6	34	10
50625 00 01 X7 NB	8	36	10
50625 00 01 X9 NB	10	45	10
50625 00 01 Y1 NB	12	50	10

50700

RIDUZIONE

REDUCER
REDUZIERUNG
RÉDUCTION ENCLIQUETABLE
REDUCCIÓN
REDUÇÃO

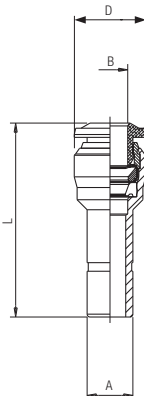

Code	A	B	L	D	Pack.
50700 00 006	4	3	30	8.5	10
50700 00 004	5	4	32	11.5	10
50700 00 001	6	4	30	10.5	10
50700 00 005	6	5	34.5	11.5	10
50700 00 008	8	4	32.5	10.5	10
50700 00 002	8	6	34.5	12.5	10
50700 00 009	10	4	31.5	10.5	10
50700 00 011	10	6	37.5	12.5	10
50700 00 003	10	8	38.5	14.5	10
50700 00 007	12	8	39.5	14.5	10
50700 00 010	12	10	43	17.5	10

55800

CARTUCCE A COMPRESIONE

PUSH-FIT CARTRIDGES
EINPRESSPATRONEN
CARTOUCHE
CARTUCHO A COMPRESIÓN
CARTUCHO DE COMPRESSÃO

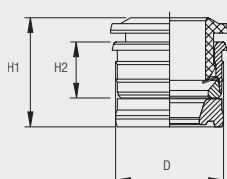

Code	Tube	D	H1	H2	Pack.
55800 00 008	3	6.7	9.4	5.2	25
55800 00 001	4	8.7	10.9	5.6	25
55800 00 002	5	9.75	12.1	6.3	25
55800 00 003	6	10.75	12.9	6.9	25
55800 00 004	8	12.7	13	6.85	25
55800 00 005	10	15.7	15.5	8.5	25
55800 00 006	12	18.3	17.7	9.5	25

HIGH QUANTITY

55800 00 008 QS	3	6.7	9.4	5.2	1000
55800 00 001 QS	4	8.7	10.9	5.6	1000
55800 00 002 QS	5	9.75	12.1	6.3	500
55800 00 003 QS	6	10.75	12.9	6.9	500
55800 00 004 QS	8	12.7	13	6.85	500
55800 00 005 QS	10	15.7	15.5	8.5	500
55800 00 006 QS	12	18.3	17.7	9.5	500

SEDE
SEAT
BOHRUNGEN
IMPLANTATION
SEDE
SEDE

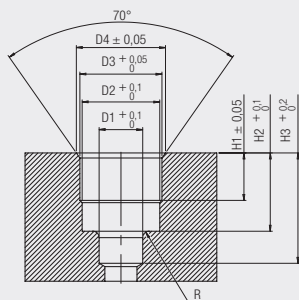

Dimensioni sedi cartucce a compressione.

Seats dimensions push-fit cartridges.
Bohrungsangaben für die einpresspatronen.
Dimensions des logements des cartouches.
Dimensiones sede cartucho a compresión.
Dimensão da sede do cartucho de compressão.

Tube	D1	D2	D3	D4	H1	H2	H3	R
3	3.4	6.05	6.4	6.95	3.7	6.1	8.6	0.5
4	4.2	7.45	8.4	9	3.75	6.5	9.5	0.5
5	5.2	8.35	9.4	10.15	4.45	7.9	10.5	0.5
6	6.2	9.35	10.45	11.35	5	8.5	11.5	0.5
8	8.2	11.4	12.4	12.9	5.2	8.5	12.5	0.75
10	10.2	14.5	15.4	16	6.7	10.5	15	0.75
12	12.2	17	18	19	7.5	12.1	17	1

ISTRUZIONI DI MONTAGGIO CARTUCCE A COMPRESSIONE ART. 55800

PUSH-FIT CARTRIDGES ASSEMBLING INSTRUCTIONS ART. 55800

ANLEITUNG FÜR DIE MONTAGE DER EINPRESSPATRONEN ART. 55800

INSTRUCTIONS DE MONTAGE POUR CARTOUCHE RÉF. 55800

INSTRUCCIONES DE MONTAJE CARTUCHO A COMPRESIÓN ART. 55800

INSTRUÇÕES DE MONTAGEM DO CARTUCHO DE COMPRESSÃO CÓD. 55800

1

Realizzare la sede per la cartuccia utilizzando l'apposita fresa Art. 55801.

Make the seat for the cartridge utilizing the suitable tool Art. 55801.

Machen sie die Sitze für die Einpresspatronen mit dem entsprechenden Stufenbohrer Art. 55801.

Usiner le logement de la cartouche à l'aide de l'outil de perçage réf. 55801.

Realizar la sede para el cartucho utilizando la correspondiente fresa Art. 55801.

Realize a furação da sede para o cartucho utilizando a fresa de cód. 55801.



2

Inserire la guarnizione sagomata nell'apposita sede.

Insert the seal inside of the seat.

Legen sie die dichtung in die Bohrung ein.

Insérer le joint dans le logement.

Insertar la junta en la correspondiente sede.

Insira vedação no fundo da sede.

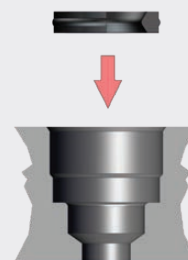

3

Inserire la cartuccia nel canotto di montaggio Art. 55802.

Insert the cartridge into the assembling tool Art. 55802.

Legen sie die Einpresspatrone in das Montagewerkzeug Art. 55802.

Insérer la cartouche dans l'outil de montage réf. 55802.

Insertar el cartucho en el útil de montaje Art. 55802.

Insira o cartucho no tubete de montagem Cód. 55802.

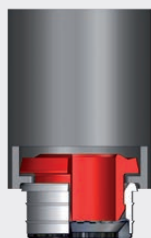

4

Premere la cartuccia all'interno della sede fino ad arrivare in battuta sul piano con il canotto.

Press the cartridge inside of the seat until it will be reached the abutment surface with the assembling tool.

Drücken sie die Einpresspatrone in die Bohrung, bis das Montagewerkzeug am Werkstück ansteht.

Presser la cartouche dans le logement jusqu'à ce que l'outil de montage soit en contact avec la surface.

Empujar el cartucho al interior de la sede hasta llegar al plano con el útil de montaje.

Pressione o cartucho no interior da sede até tocar a superfície de montagem com o tubete.

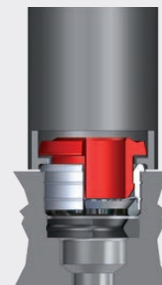

55801

FRESA SEDE CARTUCCE A COMPRESSIONE

TOOL FOR PUSH-FIT CARTRIDGES SEAT
 STUFENBOHRER FÜR EINPRESSPATRONEN
 OUTIL DE PERCAGE POUR CARTOUCHE
 FRESA SEDE CARTUCHO A COMPRESIÓN
 FRESA PARA FURAÇÃO DA SEDE DO CARTUCHO DE COMPRESSÃO



Code	Tube	ø Body	Pack.
55801 00 007	3	10	1
55801 00 001	4	10	1
55801 00 006	5	12	1
55801 00 002	6	12	1
55801 00 003	8	12	1
55801 00 004	10	16	1
55801 00 005	12	16	1

55802

CANOTTO MONTAGGIO CARTUCCE A COMPRESSIONE

ASSEMBLING TOOL FOR PUSH-FIT CARTRIDGES
 MONTAGWERKZEUG FÜR EINPRESSPATRONEN
 OUTIL DE MONTAGE POUR CARTOUCHE
 ÚTIL DE MONTAJE CARTUCHO A COMPRESIÓN
 TUBETE PARA MONTAGEM DO CARTUCHO DE COMPRESSÃO

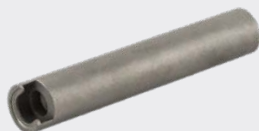

Code	Tube	Pack.
55802 00 001	3	1
55802 00 002	4	1
55802 00 003	5	1
55802 00 004	6	1
55802 00 005	8	1
55802 00 006	10	1
55802 00 007	12	1

50900

RIPARTITORE IN ALLUMINIO A 5 VIE

ALUMINIUM MANIFOLD 5 WAYS
 ALUMINIUM-VERTEILER MIT 5 AUSGÄNGEN
 BLOQUE DE DISTRIBUTION EN ALUMINIUM (5 SORTIES)
 REGLETA EN ALUMINIO A 5 VÍAS
 DISTRIBUIDOR EM ALUMÍNIO DE 5 VIAS

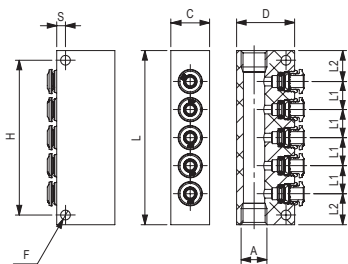

Code	Tube	A	H	F	C	S	D	L	L1	L2	Pack.
50900 00 001	4	1/8	66	5	15	4.5	25	75	12	13.5	5
50900 00 002	6	1/8	80	5	15	4.5	25	90	14.5	16	5
50900 00 003	6	1/4	80	5	20	4.5	30	90	14.5	16	5
50900 00 004	8	1/4	90	5	20	4.5	30	100	16	18	5

50980

CLIP DI SICUREZZA

SECURITY CLIPS
SICHERHEITSCLIP
CLIP DE SECURITÉ
CLIP DE SEGURIDAD ROJO
CLIP DE SEGURANÇA

Code	Tube	Pack.
50980 00 32 X1 RO	4 (5/32)	50
50980 00 32 X3 RO	5	50
50980 00 32 X4 RO	6 (1/4)	50
50980 00 32 X7 RO	8 (5/16)	50
50980 00 32 X9 RO	10 (3/8)	50
50980 00 32 Y1 RO	12 (1/2)	50
50980 00 32 Y3 RO	14	50

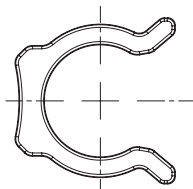

50990

LEVA SGANCIO ADATTATORI

TOOL FOR DISASSEMBLING
LÖSEWERKZEUG
OUTIL DE DÉMONTAGE
LLAVE DE DESMONTAJE
FERRAMENTA PARA DESMONTAGEM

Code	Pack.
50990 00 001	10

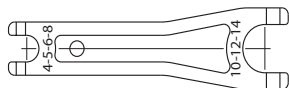

50006

ANELLO DI TENUTA PER FILETTI CONICI "UNIVERSAL SHORT"

THREAD PACKING FOR THE "UNIVERSAL SHORT" TAPER THREADS
DICHRINGE FÜR KONISCHE GEWINDE "UNIVERSAL SHORT"
BAGUE D'ÉTANCHÉITÉ POUR FILETAGES CONIQUES "UNIVERSAL SHORT"
JUNTA DE CIERRE PARA ROSCAS CÓNICAS "UNIVERSAL SHORT"
ANEL DE VEDAÇÃO PARA ROSCAS CÔNICA "UNIVERSAL SHORT"

Code	Thread	Pack.
50006 00 24 02 00	1/8	10
50006 00 24 03 00	1/4	10
50006 00 24 04 00	3/8	10
50006 00 24 05 00	1/2	10

