

 1000 Pag. 10.7	 1010 Pag. 10.7	 1015 Pag. 10.7	New  1020 Pag. 10.8	 1021 Pag. 10.8	 1025 Pag. 10.8	 1026 Pag. 10.9	 1027 Pag. 10.9	 1028 Pag. 10.9
 1029 Pag. 10.10	 1030 Pag. 10.10	 1035 Pag. 10.10	 1040 Pag. 10.11	 1050 Pag. 10.11	 1100 Pag. 10.11	 1101 Pag. 10.12	 1110 Pag. 10.12	New  1115 Pag. 10.12
 1120 Pag. 10.13	 1130 Pag. 10.13	 1200 Pag. 10.13	 1210 Pag. 10.14	 1215 Pag. 10.14	 1220 Pag. 10.14	 1230 Pag. 10.15	 1300 Pag. 10.15	 51410 Pag. 10.15
 51420 Pag. 10.16	 51430 Pag. 10.16	 51440 Pag. 10.16	 1500 Pag. 10.17	 1510 Pag. 10.17	 LG 410 Pag. 10.17	 LG 500 Pag. 10.18	 1600 Pag. 10.18	 1610 Pag. 10.19
 1612 Pag. 10.19	 1613 Pag. 10.19	 1700 Pag. 10.20	 1710 Pag. 10.20	 1750 Pag. 10.20	 8610 Pag. 10.21			

RACCORDI A CALZAMENTO

PUSH-ON FITTINGS

ÜBERWURFVERSCHRÄUBUNGEN

RACCORDS À COIFFE

RACORDAJE RÁPIDO

CONEXÕES PUSH-ON

Serie 1000



I raccordi Aignep della serie 1000, sfruttano la collaudata tecnologia a "calzamento", per poter connettere in estrema sicurezza tubi termoplastici per applicazioni pneumatiche e fluidiche. Non hanno elementi di tenuta elastomerica e consentono in maniera semplice ed affidabile connessioni in svariati mercati. Il particolare profilo del portagomma consente una migliore connessione dei tubi, mentre l'esagono del dado di serraggio posto in alto semplifica notevolmente il serraggio con la chiave.

Principali vantaggi

- Tecnologia collaudata
- Compatibilità numerosi fluidi industriali
- Tenuta garantita su differenti tipologie di tubi
- Senza elementi di tenuta (elastomeri)
- Robustezza meccanica
- Silicon Free

Applicazioni

- Aria Compressa
- Automazione Pneumatica
- Circuiti acqua industriale
- Gas inerti, vapore, fluidi
- Vuoto

The 1000 serie are push-on brass fittings to connect safely with thermoplastic tubes in pneumatic and fluid applications.

The sealing is metallic and the connection is very easy thanks to the particular shape of the hose adaptor.

The hexagon of the locking nut is always on top to facilitate mounting.

Main advantages

- Tested technology
- All Fluids Compatibility
- Safely connection
- Metallic sealing
- Mechanical resistance
- Silicon Free

Applications

- Compressed Air
- Pneumatic Automation
- Industrial Cooling
- Inert Gases, Steam, fluids
- Vacuum

Die 1.000-Serie sind Überwurf-Verschraubungen aus Messing, für die sichere Verbindung von thermoplastischen Rohren in Pneumatik- und Fluidik-Anwendungen Die Dichtung ist metallisch und die Verbindung sehr einfach, dank der besonderen Form des Schlauchadapters.

Zur Erleichterung der Montage ist der Sechskant der immer am Kopf der Sicherungsmutter.

Hauptvorteile

- Getestete Technologie
- Kompatibel mit allen Medien
- Sichere Verbindung
- Metallische Dichtung
- Mechanische Festigkeit
- Silikonfrei

Anwendungen

- Druckluft
- Pneumatische Automation
- Industrie-Kühlung
- Inertgase, Dampf
- Vakuum

La série 1000 sont raccords de compression "push on" tout en laiton pour se raccorder en toute sécurité directement avec des tubes en thermoplastiques pour les applications pneumatiques et tous fluides.

L'étanchéité est directe sur le tube et la connexion est facilité grâce à la forme particulière de la coiffe.

Le six pans de l'écrou de serrage est toujours sur l'extrémité pour faciliter le montage.

Principaux avantages

- Technologie éprouvée
- Large compatibilité avec les fluides industriels
- Raccordement sécurisé
- Étanchéité métal/métal
- Grande résistance mécanique
- Sans Silicone

Applications

- Air comprimé
- Automatisation pneumatique
- Refroidissement industriel
- Gaz neutres, vapeur
- Vide

Los racores Aignep de la serie 1000, aprovechan la probada tecnología a "calzamiento", para poder conectar con extremada seguridad tubos termoplásticos para aplicaciones neumáticas y fluidicas.

No disponen de elementos de estanqueidad elastomerica y consienten de modo simple y fiable conexiones en diferentes mercados.

El particular perfil de la espiga consiente una mejor conexión del tubo, mientras que el hexágono de la tuerca de bloqueo en la parte superior simplifica notablemente el bloqueo con la llave.

Principales ventajas

- Tecnología probada
- Compatibilidad con numerosos fluidos industriales
- Estanqueidad garantizada con diferentes tipos de tubo
- Sin elementos de estanqueidad (elástomeros)
- Robustez mecánica
- Libre de silicona

Aplicaciones

- Aire comprimido
- Automatización neumática
- Circuitos de agua industrial
- Gases inertes, vapor, fluidos
- Vacío

A série 1000 é uma linha de conexões push-on fabricadas em latão niquelado utilizadas para conectar com segurança tubos termo-plásticos em aplicações pneumáticas e de fluidos.

A vedação é metálica e a conexão é muito facilitada, graças ao design particular do adaptador de encaixe dos tubos.

O sextavado da porca de travamento é localizado sempre no topo para facilitar a montagem.

Principais vantagens

- Tecnologia testada
- Compatibilidade com todos os fluidos
- Segurança na conexão
- Vedação metálica
- Resistência Mecânica
- Livre de Silicone

Aplicações

- Ar Comprimido
- Automação pneumática
- Refrigeração Industrial
- Gases Inertes, Vapor
- Vácuo



CARATTERISTICHE TECNICHE
 TECHNICAL CHARACTERISTICS
 TECHNISCHE ANGABEN
 CARACTÉRISTIQUES TECHNIQUES
 CARACTERÍSTICAS TÉCNICAS
 CARACTERÍSTICAS TÉCNICAS



Norma di Riferimento
 Reference standard
 Entspricht der Norm
 Norme de référence
 Normativa de referencia
 Norma de referència

1907/2006
REACH ✓

2011/65/CE
RoHS ✓

PED
 2014/68/UE

**SILICON
 FREE**

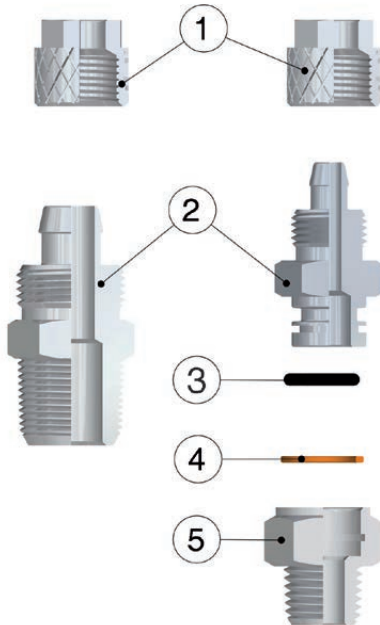

In nessun caso i raccordi "girevoli" devono essere impiegati come giunti rotanti.
 Under no circumstances, the "orienting" fittings can be used as revolving joints.
 In keinem Fall sollten "drehbare" verschraubungen als rotierende eingesetzt werden.
 Ne pas utiliser les raccords orientables comme raccords tournants.
 En ningún caso los racores "giratorios" deben ser empleados como rotativos.
 Em nenhum caso as conexões "orientáveis" devem ser aplicadas como juntas rotativas.

Materiali e Componenti	IT	Component Parts and Materials	GB	Komponenten und Materialien	DE
1 Dado in Ottone Nichelato		1 Nickel-plated Brass Nut		1 Überwurfmutter Messing vernickelt	
2 Corpo in Ottone Nichelato		2 Nickel-plated Brass Body		2 Körper Messing vernickelt	
3 Guarnizione O-Ring in NBR		3 NBR O-RING Seals		3 O-Ring NBR	
4 Seeger in Bronzo		4 Bronze Seeger		4 Sicherungsring Bronze	
5 Basetta in ottone Nichelato		5 Nickel-plated Brass Base		5 Grundkörper Messing vernickelt	

Matériaux et Composants	FR	Materiales y Componentes	ES	Materiais e Componentes	PT
1 Erou: Laiton nickelé		1 Tuerca en latón niquelado		1 Porca em Latão Niquelado	
2 Corps: Laiton nickelé		2 Cuerpo en latón niquelado		2 Corpo em Latão Niquelado	
3 Joint torique: NBR		3 Junta tórica O-Ring en NBR		3 Vedação O-Ring em NBR	
4 Bague de sécurité: bronze		4 Seeger en bronze		4 Anel de Retenção tipo Seeger em Bronze	
5 Corps: Laiton nickelé		5 Base en latón niquelado		5 Base em Latão Niquelado	



Fluidi compatibili
 Aria compressa

Fluidi e liquidi compatibili con il tipo di raccordo.

Fluids

Compressed air

Fluids and liquids compatible with the connection.

Geeignete Medien

Druckluft

Medien und Flüssigkeiten, die beständig mit den Komponenten der Verschraubungen sind.

Fluides compatibles

Air comprimé

Fluides et liquides compatibles avec les matériaux constituant les raccords.

Fluidos compatibles

Aire comprimido

Fluidos y líquidos compatibles con el tipo de conexión.

Fluidos compatíveis

Ar comprimido

Fluidos e líquidos compatíveis com o tipo de conexão.



Pressioni e Temperature	IT	Pressures and Temperatures	GB	Druckbereich und Temperatur	DE				
<p>Pressioni e temperature sono determinate dal tipo di tubo impiegato, pertanto tali valori sono da definirsi in base alle caratteristiche del tubo stesso.</p> <p>Per i raccordi nella versione "girevole e O-RING sul filetto" i valori sono: - 20 °C / + 80 °C</p>	<p>The working pressures and working temperatures depend on which type of tube is used, for this reason, the values must be determined in accordance with the tube's features.</p> <p>For the "orienting and thread with O-RING" fittings, the values are: - 20 °C / + 80 °C</p>	<p>Die Drücke und Temperaturen sind vom eingesetzten Rohr abhängig, die Werte werden durch die Eigenschaften des Rohres definiert.</p> <p>Für Verschraubungen der Version "Drehbar" sind folgende Werte zu beachten: - 20 °C / + 80 °C</p>		Pressions et Températures	FR	Presiones y Temperaturas	ES	Pressões e Temperaturas	PT
<p>La pression et la température d'utilisation des raccords sont liées au type de tube utilisé. Pour définir ces valeurs, se référer aux caractéristiques techniques du tube utilisé.</p> <p>Les valeurs suivantes sont à respecter pour les raccords "orientable": - 20 °C / + 80 °C</p>	<p>Presión y temperatura son determinadas en función del tubo empleado, por tanto estos valores se definen en base a las características del mismo tubo.</p> <p>Para los racores de la versión "giratoria" los valores son: - 20 °C / + 80 °C</p>	<p>Pressões e temperaturas são determinadas pelo tipo de tubo empregado, portanto tais valores devem ser definidos com base nas características do tubo em utilização</p> <p>Para as conexões na versão "orientável e com O-RING na rosca" os valores são: - 20 °C / + 80 °C</p>							



Tubi di Collegamento	IT	Connection Tubes	GB	Geeignete Rohre	DE				
<p>Tubi in materiale plastico: PA6, PA11, PA12, Polietilene, *Poliuretano, PTFE, FEP. *Utilizzo da 90 a 98 Shore, per la massima prestazione è consigliato 98 Shore A.</p>	<p>Plastic tubes: PA6, PA11, PA12, Polyethylene, *Polyurethane, PTFE, FEP. *Use from 90 to 98 Shore, for maximum performance is recommended 98 Shore A.</p>	<p>Kunststoffrohre: PA6, PA11, PA 12, Polyethylene, *Polyurethan, PTFE, FEP. *Verwenden Sie 90 bis 98 Shore, für maximale Leistung wird 98 Shore A empfohlen.</p>		 Tubes Conseillés	FR	 Tubos de Conexión	ES	 Tubos de Conexão	PT
<p>Tubes plastiques: PA6, PA11, PA12, Polyéthylène, *Polyuréthane, PTFE, FEP. *Utilisation de 90 à 98 Shore, pour une performance maximale recommandée 98 Shore A.</p>	<p>Tubos en material plástico: PA6, PA11, PA 12, Polietileno, *Poliuretano, PTFE, FEP. *Uso de 90 a 98 Shore, para un máximo rendimiento se recomienda 98 Shore A.</p>	<p>Tubos em material plástico: PA6, PA11, PA12, Polietileno, *Poliuretano, PTFE, FEP. *Uso de 90 a 98 Shore, para o desempenho máximo é recomendado 98 Shore A.</p>							



Filettatura	IT	Threads	GB	Gewindearten	DE				
<p>Gas conica conforme ISO 7.1, BS 21, DIN 2999. Gas cilindrica conforme ISO 228 Classe A. Metrica conforme ISO R/262.</p>	<p>Tapered gas in conformity with ISO 7.1, BS 21, DIN 2999. Parallel gas in conformity with ISO 228 Class A. Metric in conformity with ISO R/262.</p>	<p>Konisches Gewinde nach Norm ISO 7.1, BS 21, DIN 2999. Zylindrisches Gewinde nach Norm ISO 228 Classe A. Metrisches Gewinde nach Norm ISO R/262.</p>		Filetages	FR	Roscas	ES	Roscas	PT
<p>Filetage conique conforme: ISO 7.1, BS 21, DIN 2999. Filetage cylindrique conforme: ISO 228 Classe A. Filetage métrique conforme: ISO R/262.</p>	<p>Gas cónica conforme ISO 7.1, BS 21, DIN 2999. Gas cilíndrica conforme ISO 228 Classe A. Métrica conforme ISO R/262.</p>	<p>Gas cônica conforme ISO 7.1, BS 21, DIN 2999. Gas paralela conforme ISO 228 Classe A. Métrica conforme ISO R/262.</p>							



Misure specifiche per tubi in POLIURETANO

Particular sizes for the POLYURETHANE tubing

Spezial Abmessungen für POLYURETHAN Rohre

Dimensions spécifiques pour tube POLYURETHANE

Medidas específicas para tubo en POLIURETANO

Tamanhos específicos para tubos de POLIURETANO

Polyurethane tubing	Suggested size
8/5 - 8/5.5	8/6
12/9	12/8

1

Inserire il tubo nel dado.

Insert the tube on the nut.

Schieben sie das Rohr durch die Überwurfmutter.

Insérer le tube à travers l'écrou.

Insertar el tubo en la tuerca.

Insira o tubo na porca.

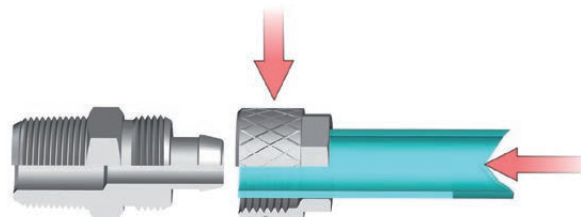

2

Infilare il tubo sul cono di calzamento.

Thread the tube on the fitting cone.

Stecken sie das Rohr auf den Konus der Verschraubung.

Insérer le tube sur la canule.

Introducir el tubo en el cono del racor.

Engate o tubo no cone de engate da conexão.

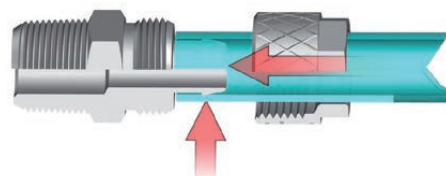

3

Avvitare il dado di bloccaggio a mano o con una chiave.

Tighten the nut by hand or with a spanner.

Ziehen sie die Überwurfmutter von Hand oder mit einem Schlüssel an.

Assembler et serrer l'écrou à la main ou avec une clé.

Atornillar la tuerca de bloqueo a mano o con una llave.

Aperte a porca apertando com a mão ou com uma chave adequada.

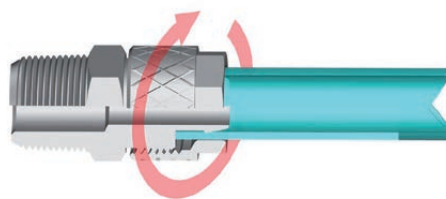

1000

RACCORDO DIRITTO MASCHIO CONICO

STRAIGHT MALE ADAPTOR (TAPER)

GERADE EINSCHRAUBVERSCHRAUBUNG KONISCH

RACCORD DROIT MÂLE CONIQUE

RACOR RECTO MACHO CÔNICO

CONEXÃO RETA MACHO COM ROSCA CÔNICA

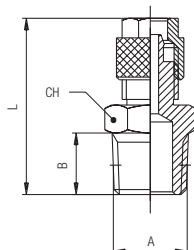

Code	Tube	A	B	L	CH	Pack.
01000 00 001	4/2.7	1/8	7.5	23.5	12	10
01000 00 002	5/3	1/8	7.5	23	12	10
01000 00 003	6/4	1/8	7.5	25.6	12	10
01000 00 004	6/4	1/4	11	29.6	14	10
01000 00 005	6/4	3/8	11.5	30	17	10
01000 00 006	8/6	1/8	7.5	26.9	14	10
01000 00 007	8/6	1/4	11	30.9	14	10
01000 00 008	8/6	3/8	11.5	31.4	17	10
01000 00 009	8/6	1/2	14	34	22	10
01000 00 010	10/8	1/8	7.5	29	14	10
01000 00 011	10/8	1/4	11	33	14	10
01000 00 012	10/8	3/8	11.5	33.5	17	10
01000 00 013	10/8	1/2	14	36.5	22	10
01000 00 014	12/10	3/8	11.5	35	17	10
01000 00 015	12/10	1/2	14	38	22	10
01000 00 016	15/12.5	1/2	14	40	22	10

1010

RACCORDO DIRITTO ORIENTABILE MASCHIO CONICO

ORIENTING STRAIGHT MALE ADAPTOR (TAPER)

GERADE EINSCHRAUBVERSCHRAUBUNG KONISCH (DREHBAR)

RACCORD ORIENTABLE DROIT MÂLE CONIQUE

RACOR RECTO ORIENTABLE MACHO CÔNICO

CONEXÃO RETA MACHO ORIENTÁVEL COM ROSCA CÔNICA

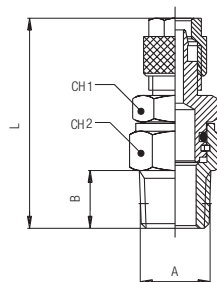

Code	Tube	A	B	L	CH1	CH2	Pack.
01010 00 001	6/4	1/8	7.5	33.5	12	13	10
01010 00 002	6/4	1/4	11	40	14	15	10
01010 00 003	8/6	1/8	7.5	33.5	12	13	10
01010 00 004	8/6	1/4	11	40	14	15	10
* 01010 00 007	10/6.5	1/4	11	41	14	15	10
01010 00 005	10/8	1/4	11	41	14	15	10
* 01010 00 008	12/8	3/8	11.5	43.5	17	17	10
01010 00 006	12/10	3/8	11.5	43.5	17	17	10

* Misure specifiche per tubi in POLIURETANO.

* Particular sizes for the POLYURETHANE tubing.

* Spezial Abmessungen für POLYURETHAN Rohre.

* Dimensions spécifiques pour tube POLYURETHANE.

* Medidas específicas para tubo en POLIURETANO.

* Tamanhos específicos para tubos de POLIURETANO.

1015

RACCORDO DIRITTO ORIENTABILE MASCHIO CILINDRICO

ORIENTING STRAIGHT MALE ADAPTOR (PARALLEL)

GERADE EINSCHRAUBVERSCHRAUBUNG ZYLINDRISCH (DREHBAR)

RACCORD ORIENTABLE DROIT MÂLE CYLINDRIQUE

RACOR RECTO ORIENTABLE MACHO CILÍNDRICO CON TÓRICA

CONEXÃO RETA MACHO ORIENTÁVEL COM ROSCA PARALELA

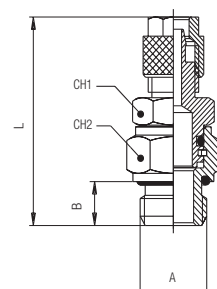

Code	Tube	A	B	L	CH1	CH2	Pack.
01015 00 001	6/4	1/8	5.4	34	12	13	10
01015 00 002	6/4	1/4	7.1	38	14	16	10
01015 00 003	8/6	1/8	5.4	34	12	13	10
01015 00 004	8/6	1/4	7.1	38	14	16	10
* 01015 00 005	10/6.5	1/4	7.1	40	14	16	10
01015 00 006	10/8	1/4	7.1	39	14	16	10
* 01015 00 007	12/8	3/8	8.1	42.5	17	18	10
01015 00 008	12/10	3/8	8.1	42.5	17	18	10

* Misure specifiche per tubi in POLIURETANO.

* Particular sizes for the POLYURETHANE tubing.

* Spezial Abmessungen für POLYURETHAN Rohre.

* Dimensions spécifiques pour tube POLYURETHANE.

* Medidas específicas para tubo en POLIURETANO.

* Tamanhos específicos para tubos de POLIURETANO.

1020

New

RACCORDO DIRITTO MASCHIO CILINDRICO

STRAIGHT MALE ADAPTOR (PARALLEL)

GERADE EINSCHRAUBVERSCHAUBUNG ZYLINDRISCH

RACCORD DROIT MÂLE, CYLINDRIQUE

RACOR RECTO MACHO CILÍNDRICO CON TÓRICA

CONEXÃO RETA MACHO COM ROSCA PARALELA

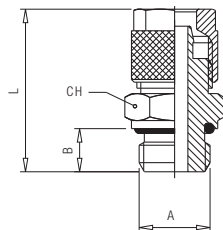

Code	Tube	A	B	L	CH	Pack.
01020 00 001	4/2.7	1/8	5.4	23	13	10
01020 00 002	5/3	1/8	5.4	25.1	13	10
01020 00 003	6/4	1/8	5.4	25.1	13	10
01020 00 004	6/4	1/4	7.1	28.1	16	10
01020 00 005	6/4	3/8	8.1	29.1	19	10
01020 00 006	6/4	1/2	9.6	32	24	10
01020 00 007	8/6	1/8	5.4	26.4	14	10
01020 00 008	8/6	1/4	7.1	29.4	16	10
01020 00 009	8/6	3/8	8.1	30.4	19	10
01020 00 010	8/6	1/2	9.6	32	24	10
01020 00 020	10/6.5	1/4	7.1	31.5	16	10
01020 00 021	10/6.5	3/8	8.1	32.5	19	10
01020 00 011	10/8	1/8	5.4	28.5	14	10
01020 00 012	10/8	1/4	7.1	31.5	16	10
01020 00 013	10/8	3/8	8.1	32.5	19	10
01020 00 014	10/8	1/2	9.6	34.5	24	10
01020 00 022	12/8	3/8	8.1	32.5	19	10
01020 00 023	12/8	1/2	9.6	34.5	24	10
01020 00 015	12/10	3/8	8.1	34	19	10
01020 00 016	12/10	1/2	9.6	36	24	10
01020 00 017	15/12.5	1/2	9.6	38	24	10

1021

RACCORDO DIRITTO MASCHIO CON FILETTATURE METRICHE

STRAIGHT MALE ADAPTOR WITH METRIC THREAD

GERADE EINSCHRAUBVERSCHAUBUNG METRISCHE GEWINDE

RACCORD DROIT MÂLE, FILETAGE METRIQUE

RACOR RECTO MACHO CON TÓRICA CON ROSCA MÉTRICA

CONEXÃO RETA MACHO COM ROSCA MÉTRICA

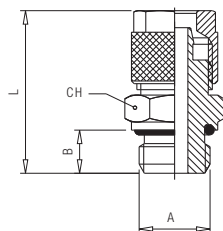

Code	Tube	A	B	L	CH	Pack.
01021 00 001	4/2.7	M5	3.6	20.5	8	10
01021 00 002	4/2.7	M6	3.6	21.5	8	10
01021 00 003	5/3	M5	3.6	23.1	8	10
01021 00 004	5/3	M6	3.6	23.1	8	10
01021 00 005	6/4	M5	3.6	23.1	8	10
01021 00 006	6/4	M6	3.6	23.1	8	10
01021 00 007	6/4	M12x1	7.3	28.1	15	10
01021 00 008	6/4	M12x1.25	7.3	28.1	15	10
01021 00 009	6/4	M12x1.5	7.3	28.1	15	10

1025

RACCORDO DIRITTO MASCHIO CONICO + DADO CON MOLLA

STRAIGHT MALE ADAPTOR (TAPER) + NUT WITH SPRING

GERADE VERSCHAUBUNG KONISCH + KNICKSCHUTZFEDER

RACCORD DROIT MÂLE, CONIQUE AVEC RESSORT DE PROTECTION

RACOR RECTO MACHO CÓNICO + TUERCA CON MUELLE

CONEXÃO RETA MACHO COM ROSCA CÔNICA + PORCA COM MOLA

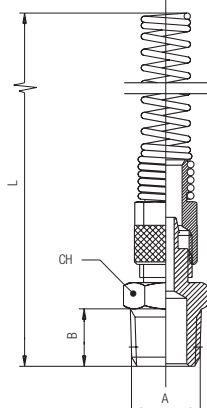

Code	Tube	A	B	L	CH	Pack.
01025 00 001	6/4	1/8	7.5	108	12	10
01025 00 002	6/4	1/4	11	112.5	14	10
01025 00 003	8/6	1/8	7.5	113.5	14	10
01025 00 004	8/6	1/4	11	118	14	10
01025 00 005	8/6	3/8	11.5	119	17	10
01025 00 006	8/6	1/2	14	121	22	10
01025 00 007	10/8	1/8	7.5	122	14	10
01025 00 008	10/8	1/4	11	126	14	10
01025 00 009	10/8	3/8	11.5	127	17	10
01025 00 010	10/8	1/2	14	130	22	10
01025 00 011	12/10	3/8	11.5	134	17	10
01025 00 012	12/10	1/2	14	137	22	10

Molla Acciaio Inox AISI 304 - EN 1.4301
 Stainless Steel Spring AISI 304 - EN 1.4301
 Edelstahlfeder AISI 304 - EN 1.4301
 Ressort Acier Inoxydable AISI 304 - EN 1.4301
 Muelle Acero Inoxidable AISI 304 - EN 1.4301
 Mola Aço Inoxidável AISI 304 - EN 1.4301

1026

RACCORDO DIRITTO ORIENTABILE MASCHIO CONICO + DADO CON MOLLA

ORIENTING STRAIGHT MALE ADAPTOR (TAPER) + NUT WITH SPRING
 GERADE VERSCHRAUBUNG KONISCH (DREHBAR) + KNICKSCHUTZFEDER
 RACCORD ORIENTABLE DROIT MÂLE, CONIQUE AVEC RESSORT DE PROTECTION
 RACOR RECTO ORIENTABLE MACHO CÓNICO + TUERCA CON MUELLE
 CONEXÃO RETA ORIENTÁVEL MACHO COM ROSCA CÔNICA + PORCA COM MOLA

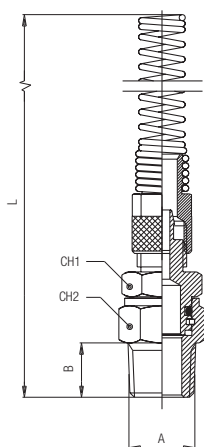

Code	Tube	A	B	L	CH1	CH2	Pack.
01026 00 001	6/4	1/8	7.5	117.5	12	13	10
01026 00 002	6/4	1/4	11	121	14	15	10
01026 00 003	8/6	1/8	7.5	121	12	13	10
01026 00 004	8/6	1/4	11	128	14	15	10
* 01026 00 005	10/6.5	1/4	11	135	14	15	10
01026 00 006	10/8	1/4	11	136	14	15	10
* 01026 00 007	12/8	3/8	11.5	144	17	17	10
01026 00 008	12/10	3/8	11.5	144	17	17	10

* Misure specifiche per tubi in POLIURETANO.
 * Particular sizes for the POLYURETHANE tubing.
 * Spezial Abmessungen für POLYURETHAN Rohre.
 * Dimensions spécifiques pour tube POLYURETHANE.
 * Medidas específicas para tubo en POLIURETANO.
 * Tamanhos específicos para tubos de POLIURETANO.

Molla Acciaio Inox AISI 304 - EN 1.4301
 Stainless Steel Spring AISI 304 - EN 1.4301
 Edelstahlfeder AISI 304 - EN 1.4301
 Ressort Acier Inoxydable AISI 304 - EN 1.4301
 Muelle Acero Inoxidable AISI 304 - EN 1.4301
 Mola Aço Inoxidável AISI 304 - EN 1.4301

1027

RACCORDO DIRITTO ORIENTABILE MASCHIO CILINDRICO + DADO CON MOLLA

ORIENTING STRAIGHT MALE ADAPTOR (PARALLEL) + NUT WITH SPRING
 GERADE VERSCHRAUBUNG ZYLINDRISCH (DREHBAR) + KNICKSCHUTZFEDER
 RACCORD ORIENTABLE DROIT MÂLE, CYLINDRIQUE AVEC RESSORT DE PROTECTION
 RACOR RECTO ORIENTABLE MACHO CILÍNDRICO CON TÓRICA + TUERCA CON MUELLE
 CONEXÃO RETA ORIENTÁVEL MACHO COM ROSCA PARALELA + PORCA COM MOLA

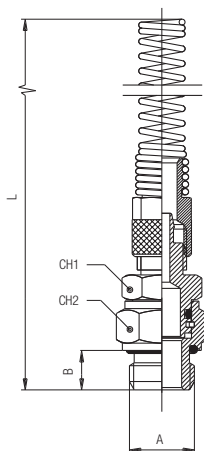

Code	Tube	A	B	L	CH1	CH2	Pack.
01027 00 001	6/4	1/8	5.4	116	12	13	10
01027 00 002	6/4	1/4	7.1	121	14	16	10
01027 00 003	8/6	1/8	5.4	122	12	13	10
01027 00 004	8/6	1/4	7.1	126	14	16	10
* 01027 00 005	10/6.5	1/4	7.1	134	14	16	10
01027 00 006	10/8	1/4	7.1	134	14	16	10
* 01027 00 007	12/8	3/8	8.1	143	17	18	10
01027 00 008	12/10	3/8	8.1	142	17	18	10

* Misure specifiche per tubi in POLIURETANO.
 * Particular sizes for the POLYURETHANE tubing.
 * Spezial Abmessungen für POLYURETHAN Rohre.
 * Dimensions spécifiques pour tube POLYURETHANE.
 * Medidas específicas para tubo en POLIURETANO.
 * Tamanhos específicos para tubos de POLIURETANO.

Molla Acciaio Inox AISI 304 - EN 1.4301
 Stainless Steel Spring AISI 304 - EN 1.4301
 Edelstahlfeder AISI 304 - EN 1.4301
 Ressort Acier Inoxydable AISI 304 - EN 1.4301
 Muelle Acero Inoxidable AISI 304 - EN 1.4301
 Mola Aço Inoxidável AISI 304 - EN 1.4301

1028

RACCORDO DIRITTO MASCHIO CILINDRICO + DADO CON MOLLA

STRAIGHT MALE ADAPTOR (PARALLEL) + NUT WITH SPRING
 GERADE VERSCHRAUBUNG ZYLINDRISCH + KNICKSCHUTZFEDER
 RACCORD DROIT MÂLE, CYLINDRIQUE AVEC RESSORT DE PROTECTION
 RACOR RECTO MACHO CILÍNDRICO CON TÓRICA + TUERCA CON MUELLE
 CONEXÃO RETA MACHO COM ROSCA PARALELA + PORCA COM MOLA

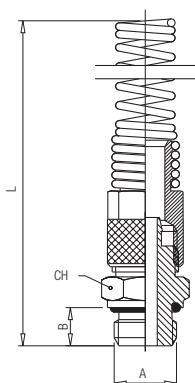

Code	Tube	A	B	L	CH	Pack.
01028 00 001	6/4	1/8	5.4	109	13	10
01028 00 002	6/4	1/4	7.1	111	16	10
01028 00 003	6/4	3/8	8.1	112	19	10
01028 00 004	6/4	1/2	9.6	114	24	10
01028 00 005	8/6	1/8	5.4	114	14	10
01028 00 006	8/6	1/4	7.1	116.5	16	10
01028 00 007	8/6	3/8	8.1	117.5	19	10
01028 00 008	8/6	1/2	9.6	119.5	24	10
01028 00 009	10/8	1/8	5.4	121.5	14	10
01028 00 010	10/8	1/4	7.1	125.5	16	10
01028 00 011	10/8	3/8	8.1	125.5	19	10
01028 00 012	10/8	1/2	9.6	128.5	24	10
01028 00 013	12/10	3/8	8.1	133	19	10
01028 00 014	12/10	1/2	9.6	134.5	24	10

Molla Acciaio Inox AISI 304 - EN 1.4301
 Stainless Steel Spring AISI 304 - EN 1.4301
 Edelstahlfeder AISI 304 - EN 1.4301
 Ressort Acier Inoxydable AISI 304 - EN 1.4301
 Muelle Acero Inoxidable AISI 304 - EN 1.4301
 Mola Aço Inoxidável AISI 304 - EN 1.4301

1029

RACCORDO DIRITTO MASCHIO CON FILETTATURE METRICHE + DADO CON MOLLA

STRAIGHT MALE ADAPTOR WITH METRIC THREAD + NUT WITH SPRING
 GERADE VERSCHRAUBUNG METRISCHE GEWINDE + KNICKSCHUTZFEDER
 RACCORD DROIT MÂLE, FILETAGE MÉTRIQUE AVEC RESSORT DE PROTECTION
 RACOR RECTO MACHO CON ROSCA MÉTRICA + TUERCA CON MUELLE
 CONEXÃO RETA MACHO COM ROSCA MÉTRICA + PORCA COM MOLA

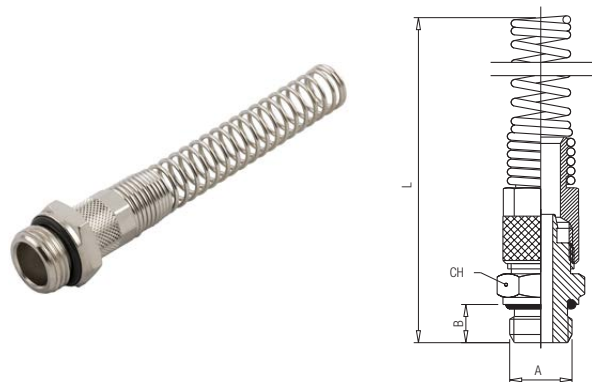

Code	Tube	A	B	L	CH	Pack.
01029 00 001	6/4	M12x1	7.3	111	15	10
01029 00 002	6/4	M12x1.25	7.3	111	15	10
01029 00 003	6/4	M12x1.5	7.3	111	15	10

Molla Acciaio Inox AISI 304 - EN 1.4301
 Stainless Steel Spring AISI 304 - EN 1.4301
 Edelstahlfeder AISI 304 - EN 1.4301
 Ressort Acier Inoxydable AISI 304 - EN 1.4301
 Muelle Acero Inoxidable AISI 304 - EN 1.4301
 Mola Aço Inoxidável AISI 304 - EN 1.4301

1030

RACCORDO DIRITTO FEMMINA

STRAIGHT FEMALE ADAPTOR
 AUFSCHRAUBVERSCHRAUBUNG
 RACCORD DROIT, TARAUEE
 RACOR RECTO HEMBRA
 CONEXÃO RETA COM ROSCA FÊMEA



Code	Tube	A	B	L	CH	Pack.
01030 00 001	6/4	1/8	8.5	23.3	14	10
01030 00 002	6/4	1/4	11	27	17	10
01030 00 003	6/4	3/8	11.5	28	22	10
01030 00 004	8/6	1/8	8	24.7	14	10
01030 00 005	8/6	1/4	11	28.7	17	10
01030 00 006	8/6	3/8	11.5	29.2	22	10
01030 00 007	8/6	1/2	15.5	33	24	10
01030 00 008	10/8	1/4	11	30.5	17	10
01030 00 009	10/8	3/8	11.5	31	22	10
01030 00 010	10/8	1/2	15.5	34.5	24	10
01030 00 011	12/10	3/8	11.5	32.5	22	10

1035

RACCORDO DIRITTO FEMMINA + DADO CON MOLLA

STRAIGHT FEMALE ADAPTOR + NUT WITH SPRING
 AUFSCHRAUBVERSCHRAUBUNG + KNICKSCHUTZFEDER
 RACCORD DROIT, TARAUEE AVEC RESSORT DE PROTECTION
 RACOR RECTO HEMBRA + TUERCA CON MUELLE
 CONEXÃO RETA COM ROSCA FÊMEA + PORCA COM MOLA

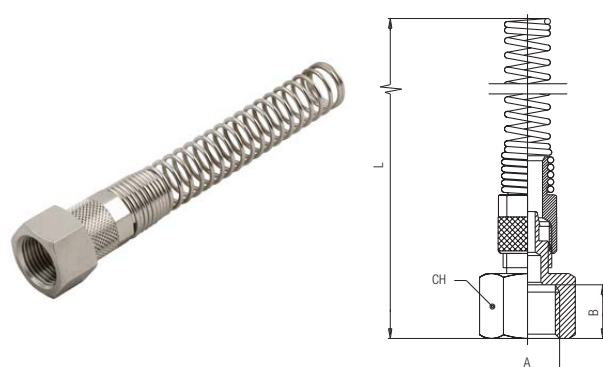

Code	Tube	A	B	L	CH	Pack.
01035 00 001	6/4	1/8	8.5	106	14	10
01035 00 002	6/4	1/4	11	109	17	10
01035 00 003	6/4	3/8	11.5	110	22	10
01035 00 004	8/6	1/8	8	112	14	10
01035 00 005	8/6	1/4	11	115.5	17	10
01035 00 006	8/6	3/8	11.5	116	22	10
01035 00 007	8/6	1/2	15.5	119.5	24	10
01035 00 008	10/8	1/4	11	123	17	10
01035 00 009	10/8	3/8	11.5	124.5	22	10
01035 00 010	10/8	1/2	15.5	128.5	24	10
01035 00 011	12/10	3/8	11.5	131	22	10

Molla Acciaio Inox AISI 304 - EN 1.4301
 Stainless Steel Spring AISI 304 - EN 1.4301
 Edelstahlfeder AISI 304 - EN 1.4301
 Ressort Acier Inoxydable AISI 304 - EN 1.4301
 Muelle Acero Inoxidable AISI 304 - EN 1.4301
 Mola Aço Inoxidável AISI 304 - EN 1.4301

1040

RACCORDO DIRITTO INTERMEDIO

STRAIGHT CONNECTOR
 VERBINDUNGSVERSCHRAUBUNG
 RACCORD UNION DOUBLE
 RACOR RECTO INTERMEDIO
 CONEXÃO RETA TUBO-TUBO

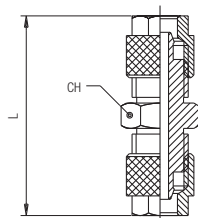

Code	Tube	Tube	L	CH	Pack.
01040 00 001	4/2.7	4/2.7	27.5	8	10
01040 00 002	5/3	5/3	31.7	8	10
01040 00 003	6/4	5/3	32.2	12	10
01040 00 004	6/4	6/4	32.2	12	10
01040 00 005	8/6	6/4	33.5	12	10
01040 00 006	8/6	8/6	34.8	12	10
01040 00 007	10/8	6/4	35.6	14	10
01040 00 008	10/8	8/6	36.9	14	10
01040 00 009	10/8	10/8	39	14	10
01040 00 010	12/10	12/10	43	17	10
01040 00 011	15/12.5	15/12.5	47	22	10

1050

RACCORDO DIRITTO INTERMEDIO DI ATTRAVERSAMENTO

BULKHEAD CONNECTOR
 SCHOTTVERSCHRAUBUNG
 RACCORD TRAVERSÉE DE CLOISON
 RACOR RECTO INTERMEDIO PASATABIQUES
 CONEXÃO PASSA-MURO RETA TUBO-TUBO

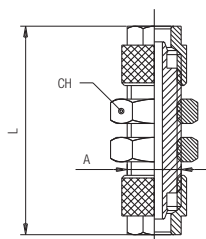

Code	Tube	Tube	A	L	CH	Pack.
01050 00 001	4/2.7	4/2.7	M6x0.5	35	10	10
01050 00 002	5/3	5/3	M7x0.75	35	10	10
01050 00 003	6/4	5/3	M10x1	45.5	14	10
01050 00 004	6/4	6/4	M10x1	45.5	14	10
01050 00 005	8/6	6/4	M12x1	47.3	17	10
01050 00 006	8/6	8/6	M12x1	48.4	17	10
01050 00 007	10/8	6/4	M14x1	49.8	17	10
01050 00 008	10/8	8/6	M14x1	51.2	17	10
01050 00 009	10/8	10/8	M14x1	52	17	10
01050 00 010	12/10	12/10	M16x1	57	19	10
01050 00 011	15/12.5	15/12.5	M20x1	59	24	10

1100

RACCORDO A L MASCHIO CONICO

ELBOW MALE ADAPTOR (TAPER)
 WINKELVERSCHRAUBUNG KONISCH (NICHT DREHBAR)
 EQUERRE MÂLE NON ORIENTABLE, CONIQUE
 RACOR A L MACHO CÓNICO
 CONEXÃO EM "L" COM ROSCA MACHO CÔNICA

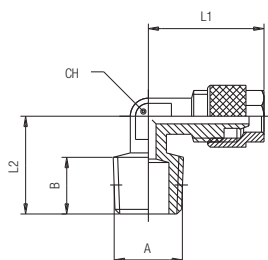

Code	Tube	A	B	L1	L2	CH	Pack.
01100 00 001	4/2.7	1/8	7.5	19.5	15	8	10
01100 00 002	5/3	1/8	7.5	19.5	15	8	10
01100 00 003	6/4	1/8	7.5	19.5	15	8	10
01100 00 004	6/4	1/4	11	20.6	19	8	10
01100 00 005	6/4	3/8	11.5	21	21	9	10
01100 00 006	8/6	1/8	7.5	19.9	16.5	9	10
01100 00 007	8/6	1/4	11	21.9	19	9	10
01100 00 008	8/6	3/8	11.5	23.4	21	9	10
01100 00 009	8/6	1/2	14	26	28	16	10
01100 00 010	10/8	1/8	7.5	25	18	11	10
01100 00 011	10/8	1/4	11	24	22	11	10
01100 00 012	10/8	3/8	12.5	25.5	22.5	11	10
01100 00 013	10/8	1/2	14	28	28	16	10
01100 00 014	12/10	3/8	11.5	27	22.5	13	10
01100 00 015	12/10	1/2	14	30	28	16	10
01100 00 016	15/12.5	1/2	14	31.5	28	16	10

1101

RACCORDO A L MASCHIO METRICO

ELBOW MALE ADAPTOR WITH METRIC THREAD
 WINKELVERSCHRAUBUNG METRISCHE GEWINDE (NICHT DREHBAR)
 EQUERRE MÂLE NON ORIENTABLE, FILETAGE MÉTRIQUE
 RACOR A L MACHO CON ROSCA MÉTRICA
 CONEXÃO EM "L" COM ROSCA MACHO METRICA

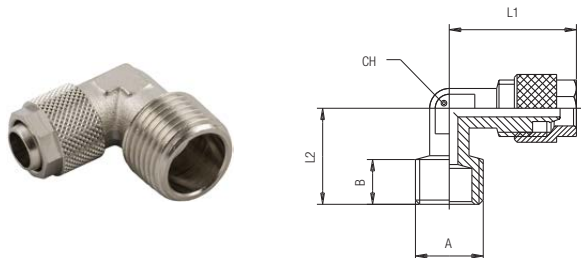

Code	Tube	A	B	L1	L2	CH	Pack.
01101 00 001	6/4	M12x1	11	20.6	19	8	10
01101 00 002	6/4	M12x1.25	11	20.6	19	8	10
01101 00 003	6/4	M12x1.5	11	20.6	19	8	10

1110

RACCORDO A L ORIENTABILE MASCHIO CONICO

ORIENTING ELBOW MALE ADAPTOR (TAPER)
 WINKELVERSCHRAUBUNG KONISCH (DREHBAR)
 EQUERRE MÂLE ORIENTABLE, CONIQUE
 RACOR A L ORIENTABLE MACHO CÓNICO
 CONEXÃO EM "L" ORIENTÁVEL COM ROSCA MACHO CÔNICA

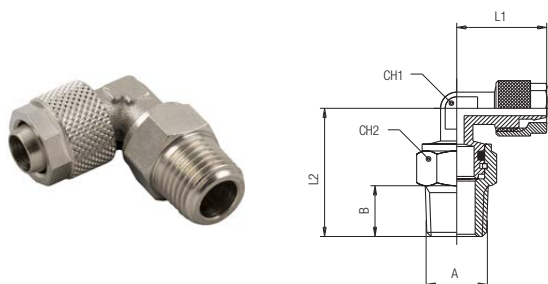

Code	Tube	A	B	L1	L2	CH1	CH2	Pack.
01110 00 006	4/2.7	1/8	7.5	20	22.5	8	13	10
01110 00 001	6/4	1/8	7.5	20.6	22.5	8	13	10
01110 00 002	6/4	1/4	11	20.6	28	8	15	10
01110 00 003	8/6	1/8	7.5	21.6	22.5	9	13	10
01110 00 004	8/6	1/4	11	23.1	28.5	9	15	10
01110 00 005	10/8	1/4	11	24	30.5	11	15	10

1115

New

RACCORDO A L ORIENTABILE MASCHIO CILINDRICO

ORIENTING ELBOW MALE ADAPTOR (PARALLEL)
 WINKELVERSCHRAUBUNG ZYLINDRISCH (DREHBAR)
 EQUERRE MÂLE ORIENTABLE, CYLINDRIQUE
 RACOR A L ORIENTABLE MACHO CILÍNDRICO CON TÓRICA
 CONEXÃO EM "L" ORIENTÁVEL COM ROSCA MACHO PARALELA

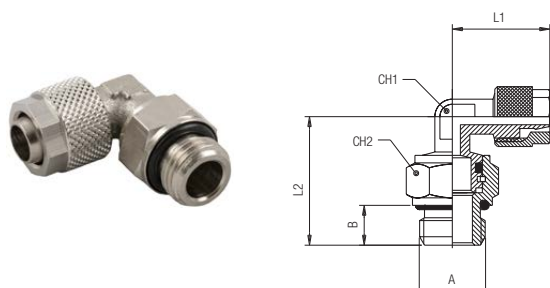

Code	Tube	A	B	L1	L2	CH1	CH2	Pack.
01115 00 006	4/2.7	1/8	5.4	18.5	22	8	13	10
01115 00 011	6/4	M5	3.6	19.5	20	8	8	10
01115 00 001	6/4	1/8	5.4	20.6	22	8	13	10
01115 00 002	6/4	1/4	7.1	20.6	26	8	16	10
01115 00 003	8/6	1/8	5.4	21.6	21.6	9	13	10
01115 00 004	8/6	1/4	7.1	23.1	26.5	9	16	10
01115 00 014	10/6.5	1/4	7.1	24	27.5	11	16	10
01115 00 015	10/6.5	3/8	8.1	24	29.5	11	18	10
01115 00 005	10/8	1/4	7.1	24	27.5	11	16	10
01115 00 013	10/8	3/8	8.1	24	29.9	11	18	10
01115 00 018	12/8	3/8	8.1	25.5	31.1	13	18	10
01115 00 019	12/8	1/2	9.	25.5	32.1	13	22	10
01115 00 016	12/10	3/8	8.1	25.5	31.1	13	18	10
01115 00 017	12/10	1/2	9.6	25.5	32.1	13	22	10

1120

RACCORDO A L FEMMINA

ELBOW FEMALE ADAPTOR
 AUFSCRAUB-WINKELSCHRAUBUNG (NICHT DREHBAR)
 EQUERRE FEMELLE ORIENTABLE
 RACOR A L HEMBRA
 CONEXÃO EM "L" COM ROSCA FÊMEA

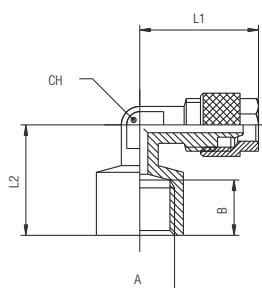

Code	Tube	A	B	L1	L2	CH	Pack.
01120 00 001	5/3	1/8	8.5	20.6	18	8	10
01120 00 002	6/4	1/8	8.5	20.6	18	8	10
01120 00 003	6/4	1/4	10.5	21	21	9	10
01120 00 004	8/6	1/8	8.5	21.9	19	9	10
01120 00 005	8/6	1/4	10.5	23.4	21	9	10
01120 00 006	10/8	1/4	10.5	25.5	22.5	11	10
01120 00 007	10/8	3/8	11.5	28	27	16	10

1130

RACCORDO A L INTERMEDIO

ELBOW CONNECTOR
 WINKELVERSCHRAUBUNG
 RACCORD EQUERRE
 RACOR A L INTERMEDIO
 CONEXÃO EM "L" TUBO-TUBO

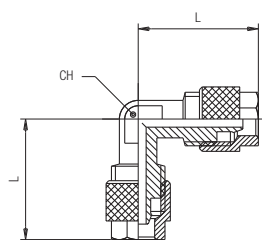

Code	Tube	Tube	L	CH	Pack.
01130 00 001	4/2.7	4/2.7	20	8	10
01130 00 002	5/3	5/3	20.6	8	10
01130 00 003	6/4	6/4	20.6	8	10
01130 00 004	8/6	6/4	21.9	9	10
01130 00 005	8/6	8/6	21.9	9	10
01130 00 006	10/8	10/8	25.5	11	10
01130 00 007	12/10	12/10	27	13	10
01130 00 008	15/12.5	15/12.5	33.5	16	10

1200

RACCORDO A T MASCHIO CONICO

TEE MALE ADAPTOR (TAPER) - CENTRE LEG
 T-EINSCHRAUBVERSCHRAUBUNG KONISCH (NICHT DREHBAR)
 TÉ NON ORIENTABLE À PIQUAGE MÂLE CENTRAL, CONIQUE
 RACOR A T MACHO CENTRAL CÔNICO
 CONEXÃO EM "T" COM ROSCA MACHO CÔNICA

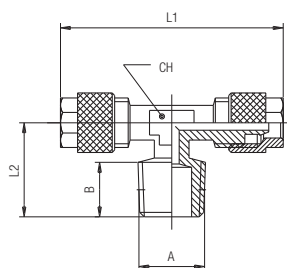

Code	Tube	A	B	L1	L2	CH	Pack.
01200 00 001	4/2.7	1/8	7.5	37	15.5	8	10
01200 00 002	5/3	1/8	7.5	39	15.5	8	10
01200 00 003	6/4	1/8	7.5	39	15.5	8	10
01200 00 004	6/4	1/4	11	41.2	19	8	10
01200 00 005	8/6	1/8	7.5	39.8	16.5	9	10
01200 00 006	8/6	1/4	11	43.8	20.5	9	10
01200 00 007	10/8	1/8	7.5	48	19	11	10
01200 00 008	10/8	1/4	11	48	22	11	10
01200 00 009	10/8	3/8	11.5	51	22	11	10
01200 00 010	12/10	3/8	11.5	54	22.5	14	10
01200 00 011	15/12.5	1/2	14	63	28	16	10

1210

RACCORDO A T ORIENTABILE MASCHIO CONICO

ORIENTING TEE MALE ADAPTOR (TAPER) - CENTRE LEG

T-EINSCHRAUBVERSCHRAUBUNG KONISCH (DREHBAR)

TÉ ORIENTABLE À PIQUAGE MÂLE CENTRAL, CONIQUE

RACOR A T ORIENTABLE MACHO CENTRAL CÓNICO

CONEXÃO EM "T" ORIENTÁVEL COM ROSCA MACHO CÔNICA

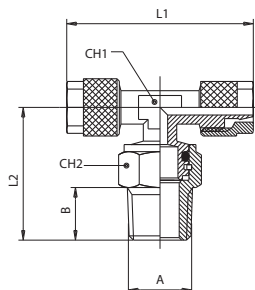

Code	Tube	A	B	L1	L2	CH1	CH2	Pack.
01210 00 001	6/4	1/8	7.5	41.2	22.5	8	13	10
01210 00 002	6/4	1/4	11	41.2	28	8	15	10
01210 00 003	8/6	1/8	7.5	43.2	24.5	9	13	10
01210 00 004	8/6	1/4	11	43.2	29.5	9	15	10
01210 00 005	10/8	1/4	11	48	29.5	11	15	10

1215

RACCORDO A T ORIENTABILE MASCHIO CILINDRICO

ORIENTING TEE MALE ADAPTOR (PARALLEL) - CENTRE LEG

T-EINSCHRAUBVERSCHRAUBUNG ZYLINDRISCH (DREHBAR)

TÉ ORIENTABLE À PIQUAGE MÂLE CENTRAL, CYLINDRIQUE

RACOR A T ORIENTABLE MACHO CENTRAL CILÍNDRICO CON TÓRICA

CONEXÃO EM "T" ORIENTÁVEL COM ROSCA MACHO PARALELA

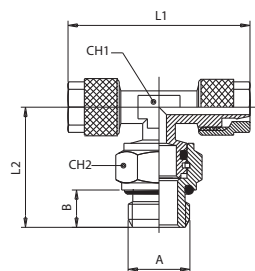

Code	Tube	A	B	L1	L2	CH1	CH2	Pack.
01215 00 001	6/4	1/8	5.4	41.2	22	8	13	10
01215 00 002	6/4	1/4	7.1	41.2	26	8	16	10
01215 00 003	8/6	1/8	5.4	43.2	24	9	13	10
01215 00 004	8/6	1/4	7.1	43.2	27.5	9	16	10
01215 00 006	10/8	1/8	5.4	48	22.5	11	13	10
01215 00 005	10/8	1/4	7.1	48	27.5	11	16	10

1220

RACCORDO A T MASCHIO LATERALE CONICO

TEE MALE ADAPTOR (TAPER) - OFF SET LEG

L-EINSCHRAUBVERSCHRAUBUNG KONISCH (NICHT DREHBAR)

TÉ NON ORIENTABLE À PIQUAGE LATÉRAL, CONIQUE

RACOR A T MACHO LATERAL CÓNICO

CONEXÃO EM "T" LATERAL COM ROSCA MACHO CÔNICA

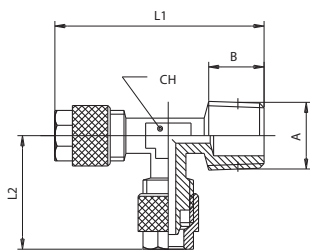

Code	Tube	A	B	L1	L2	CH	Pack.
01220 00 001	5/3	1/8	7.5	36.7	20.6	8	10
01220 00 002	6/4	1/8	7.5	36.7	20.6	8	10
01220 00 003	6/4	1/4	11	40.2	20.6	8	10
01220 00 004	8/6	1/8	7.5	38	21.9	9	10
01220 00 005	8/6	1/4	11	41.5	21.9	9	10
01220 00 006	10/8	1/8	7.5	40	25.5	11	10
01220 00 007	10/8	1/4	11	43	25.5	11	10
01220 00 008	10/8	3/8	11.5	44	25.5	11	10
01220 00 009	12/10	3/8	11.5	48.5	28	13	10
01220 00 010	15/12.5	1/2	14	57.5	32.5	16	10

1230

RACCORDO A T INTERMEDIO

TEE CONNECTOR
T-ANSCHLUSS
RACCORD TÉ
RACOR A T INTERMEDIO
CONEXÃO EM "T" TUBO-TUBO

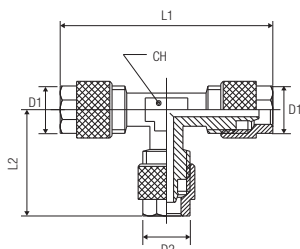

Code	D1	D2	L1	L2	CH	Pack.
01230 00 001	4/2.7	4/2.7	40	20.5	8	10
01230 00 002	5/3	5/3	41.2	20.6	8	10
01230 00 003	6/4	6/4	41.2	20.6	8	10
01230 00 004	8/6	6/4	43.8	20.6	9	10
01230 00 005	8/6	8/6	43.8	21.9	9	10
01230 00 006	10/8	6/4	51	20.6	11	10
01230 00 007	10/8	8/6	51	21.9	11	10
01230 00 008	10/8	10/8	51	25.5	11	10
01230 00 009	12/10	12/10	54	28	13	10
01230 00 010	15/12.5	15/12.5	63	32.5	16	10

1300

RACCORDO A CROCE INTERMEDIO

EQUAL CROSS CONNECTOR
KREUZ-ANSCHLUSS
CROIX ÉGALE
RACOR A CRUZ INTERMEDIO
CONEXÃO CRUZETA TUBO-TUBO

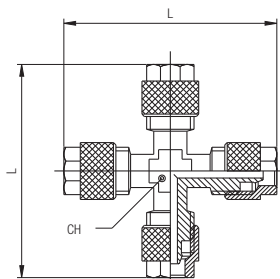

Code	Tube	L	CH	Pack.
01300 00 001	5/3	41.6	8	10
01300 00 002	6/4	41.6	8	10
01300 00 003	8/6	44.4	9	10
01300 00 004	10/8	49	11	10
01300 00 005	12/10	58	13	10
01300 00 006	15/12.5	64	17	10

51410

VITE CAVA SINGOLA

BANJO SCREW SINGLE
EINFACHE HOHLSCHRAUBE
VIS POUR BANJO SIMPLE
TORNILLO SIMPLE
HASTE PARA CONEXÃO BANJO COM 1 CAVIDADE

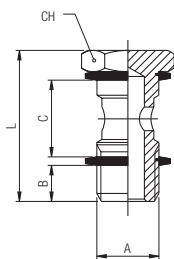

Code	A	B	C	L	CH	Pack.
51410 00 011	M5	4	12.5	22	8	10
51410 00 012	M6	5	12.5	23	8	10
51410 00 013	1/8	6	15	28	14	10
51410 00 014	1/4	8	17	32	17	10
51410 00 015	3/8	9	20	36	19	10
51410 00 016	1/2	10	24	42	24	10
* 51410 00 017	M12x1.5	8	17	32	17	10

Questo articolo viene fornito completo di rondelle in PA66 (art. 1610).

This item will be supplied with the PA66 washers (art. 1610).

Dieser artikel wird mit dichtungen aus PA66 (art. 1610) Mitgeliefert.

Livré avec joints en PA66 (art. 1610).

Este artículo viene completo de arandelas en nylon (art.1610).

Este item vem acompanhado de arruelas em PA66 (cód. 1610).

* Con questa vite utilizzare gli anelli orientabili da 1/4.

* With this banjo SCREW using 1/4 orienting banjo body.

* Bei dieser grösse können dichtringe für 1/4 eingesetzt werden.

* Compatible avec joint 1/4".

* Con este tornillo utilizar el anillo orientable de 1/4.

* Com esta haste para banjo utilizar os anéis orientáveis de 1/4.

51420

VITE CAVA DOPPIA

BANJO SCREW DOUBLE
DOPPELTE HOHLSCHRAUBE
VIS POUR BANJO DOUBLE
TORNILLO DOBLE
HASTE PARA CONEXÃO BANJO COM 2 CAVIDADES

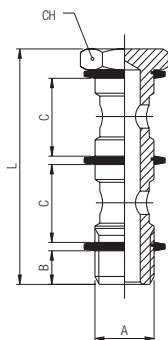

Code	A	B	C	L	CH	Pack.
51420 00 011	1/8	6	15	44.5	14	10
51420 00 012	1/4	8	17	50.5	17	10
51420 00 013	3/8	9	20	58	19	10
51420 00 014	1/2	10	24	68	24	10
51420 00 015	*M12x1.5	8	17	50.5	17	10

Questo articolo viene fornito completo di rondelle in PA66 (art. 1610).

This item will be supplied with the PA66 washers (art. 1610).

Dieser artikel wird mit dichtringen aus PA66 (art. 1610) Mitgeliefert.

Livré avec joints en PA66 (art. 1610).

Este artículo viene completo de arandelas en nylon (art.1610).

Este item vem acompanhado de arruelas em PA66 (cód. 1610).

* Con questa vite utilizzare gli anelli orientabili da 1/4.

* With this banjo SCREW using 1/4 orienting banjo body.

* Bei dieser größe können dichtringe für 1/4 eingesetzt werden.

* Compatible avec joint 1/4".

* Con este tornillo utilizar el anillo orientable de 1/4.

* Com esta haste para banjo utilizar os anéis orientáveis de 1/4.

51430

VITE CAVA TRIPLA

BANJO SCREW TRIPLE
DREIFACH HOHLSCHRAUBE
VIS POUR BANJO TRIPLE
TORNILLO TRIPLE
HASTE PARA CONEXÃO BANJO COM 3 CAVIDADES

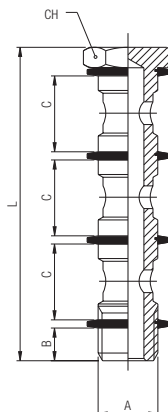

Code	A	B	C	L	CH	Pack.
51430 00 011	1/8	6	15	61	14	10
51430 00 012	1/4	8	17	69	17	10
51430 00 013	3/8	9	20	80	19	10
51430 00 014	1/2	10	24	94	24	10

Questo articolo viene fornito completo di rondelle in PA66 (art. 1610).

This item will be supplied with the PA66 washers (art. 1610).

Dieser artikel wird mit dichtringen aus PA66 (art. 1610) Mitgeliefert.

Livré avec joints en PA66 (art. 1610).

Este artículo viene completo de arandelas en nylon (art.1610).

Este item vem acompanhado de arruelas em PA66 (cód. 1610).

51440

VITE CAVA SINGOLA MASCHIO - FEMMINA

MALE - FEMALE BANJO SCREW SINGLE
AUFSCHRAUBHOHLSCHRAUBE MIT INNENGEWINDE
VIS CREUSE TARAUDÉE POUR BANJO SIMPLE
TORNILLO SIMPLE MACHO - HEMBRA
HASTE PARA CONEXÃO BANJO COM 1 CAVIDADE MACHO - FÊMEA

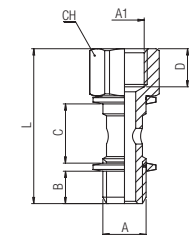

Code	A	A1	B	C	D	L	CH	Pack.
51440 00 001	1/8	1/8	6	15	8.5	34.5	14	10
51440 00 002	1/4	1/4	8	17	11	40.5	17	10
51440 00 003	3/8	3/8	9	20	12	45.5	19	10

Questo articolo viene fornito completo di rondelle in PA66 (art. 1610).

This item will be supplied with the PA66 washers (art. 1610).

Dieser artikel wird mit dichtringen aus PA66 (art. 1610) Mitgeliefert.

Livré avec joints en PA66 (art. 1610).

Este artículo viene completo de arandelas en nylon PA66 (art.1610).

Este item vem acompanhado de arruelas em PA66 (cód. 1610).

1500

ANELLO ORIENTABILE A L
 SINGLE BANJO BODY
 RINGANSCHLUSS
 CORPS SIMPLE POUR BANJO
 ANILLO ORIENTABLE SIMPLE
 ANEL ORIENTÁVEL EM "L"

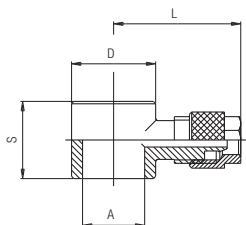

Code	Tube	A	D	S	L	Pack.
01500 00 001	4/2.7	M5	9	12.5	21.5	10
01500 00 002	4/2.7	M6	9	12.5	21.5	10
01500 00 003	4/2.7	1/8	14	15	22.5	10
01500 00 004	5/3	M5	9	12.5	22	10
01500 00 005	5/3	1/8	14	15	22.5	10
01500 00 006	6/4	M5	9	12.5	22	10
01500 00 007	6/4	M6	9	12.5	22	10
01500 00 008	6/4	1/8	14	15	23	10
01500 00 009	6/4	1/4	18	17	25	10
01500 00 010	6/4	3/8	21	20	27	10
01500 00 011	8/6	1/8	14	15	24.5	10
01500 00 012	8/6	1/4	18	17	26	10
01500 00 013	8/6	3/8	21	20	27	10
01500 00 014	8/6	1/2	26	24	31	10
01500 00 015	10/8	1/8	14	15	27.5	10
01500 00 016	10/8	1/4	18	17	27.5	10
01500 00 017	10/8	3/8	21	20	30.5	10
01500 00 018	10/8	1/2	26	24	34	10
01500 00 019	12/10	3/8	21	20	31.5	10
01500 00 020	12/10	1/2	26	24	35	10
01500 00 021	15/12.5	1/2	26	24	36.5	10

1510

ANELLO ORIENTABILE A T
 DOUBLE BANJO BODY
 DOPPELTER RINGANSCHLUSS
 CORPS DOUBLE POUR BANJO
 ANILLO ORIENTABLE DOBLE
 ANEL ORIENTÁVEL EM "T"

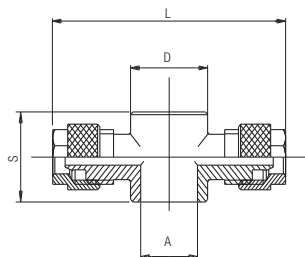

Code	Tube	A	D	S	L	Pack.
01510 00 001	4/2.7	M5	9	12.5	43	10
01510 00 002	4/2.7	1/8	14	15	43	10
01510 00 003	5/3	M5	9	12.5	43	10
01510 00 004	5/3	1/8	14	15	46.6	10
01510 00 005	6/4	M5	9	12.5	43	10
01510 00 006	6/4	1/8	14	15	46.6	10
01510 00 007	6/4	1/4	18	17	50.6	10
01510 00 008	6/4	3/8	21	20	53.6	10
01510 00 009	8/6	1/8	14	15	49.4	10
01510 00 010	8/6	1/4	18	17	55.2	10
01510 00 011	8/6	3/8	21	20	55	10
01510 00 012	8/6	1/2	26	24	61	10
01510 00 013	10/8	1/8	14	15	53	10
01510 00 014	10/8	1/4	18	17	59	10
01510 00 015	10/8	3/8	21	20	61	10
01510 00 016	10/8	1/2	26	24	66	10
01510 00 017	12/10	3/8	21	20	63	10
01510 00 018	12/10	1/2	26	24	70	10
01510 00 019	15/12.5	1/2	26	24	73	10

LG 410

VITE CAVA SINGOLA SERIE LEGGERA
 BANJO SCREW SINGLE LIGHT
 EINFACHE HOHLSCHRAUBE LEICHTE SERIE
 VIS POUR BANJO SIMPLE - SÉRIE LÉGÈRE
 TORNILLO SIMPLE SERIE LIGERA
 HASTE PARA CONEXÃO BANJO COM 1 CAVIDADE SÉRIE LEVE

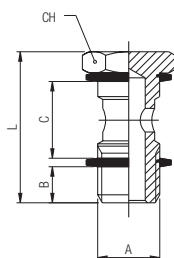

Code	A	B	C	L	CH	Pack.
LG410 00 002	M5	3.5	9	18	8	10
LG410 00 003	M6	4	9	19	8	10

Questo articolo viene fornito completo di rondelle in PA66 (art. 1610).
 This item will be supplied with the PA66 washers (art. 1610).
 Dieser artikel wird mit dichtringen aus PA66 (art. 1610) Mitgeliefert.
 Livré avec joints en PA66 (art. 1610).
 Este artículo viene completo de arandelas en nylon PA66 (art.1610).
 Este item vem acompanhado de arruelas em PA66 (cód. 1610).

LG 500

ANELLO ORIENTABILE SERIE LEGGERA

SINGLE BANJO BODY LIGHT
 RINGANSCHLUSS LEICHTE SERIE
 CORPS SIMPLE POUR BANJO - SÉRIE LÉGÈRE
 ANILLO ORIENTABLE SIMPLE SERIE LIGERA
 ANEL ORIENTÁVEL SÉRIE LEVE

Code	Tube	A	D	S	L	Pack.
LG500 00 003	4/2.7	M5	9	9	21	10
LG500 00 005	4/2.7	M6	9	9	21	10
LG500 00 004	5/3	M5	9	9	21	10
LG500 00 002	6/4	M5	9	9	21	10
LG500 00 006	6/4	M6	9	9	21	10

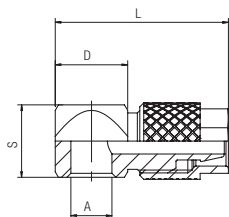

ESEMPI DI ASSEMBLAGGIO DELLE VITI CON ANELLI ORIENTABILI SINGOLI E DOPPI

ASSEMBLING EXAMPLES OF VARIOUS BANJO SCREWS WITH SINGLE AND DOUBLE BANJO BODIES
 MONTAGEBEISPIELE VON HOHLSCHRAUBEN MONTIERT MIT EINFACHEN- UND DOPPELTEN RINGANSCHLÜSSEN
 EXEMPLES D'ASSEMBLAGES DES CORPS SIMPLES ET DOUBLES
 EJEMPLO DE MONTAJE DEL TORNILLO CON EL ANILLO ORIENTABLE SIMPLE Y DOBLE
 EXEMPLOS DE MONTAGEM DOS BANJOS COM ANÉIS ORIENTÁVEIS SIMPLES E DUPLOS

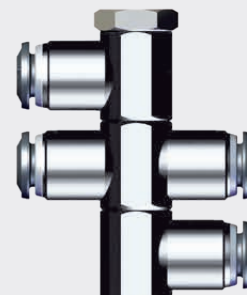
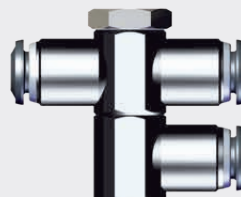

Vite cava singola
 Banjo SCREW single
 Einfache hohlschraube
 Vis pour banjo simple
 Tornillo simple
 Haste p/ banjo c/ 1 cavidade

Vite cava doppia
 Banjo SCREW double
 Doppelte hohlschraube
 Vis double pour banjo
 Tornillo doble
 Haste p/ banjo c/ 2 cavidades

Vite cava tripla
 Banjo SCREW triple
 Dreifache hohlschraube
 Vis triple pour banjo
 Tornillo triple
 Haste p/banjo c/ 3 cavidades

1600

RONDELLA IN ALLUMINIO

ALUMINIUM WASHER
 DICHTSCHEIBE AUS ALUMINIUM
 JOINT EN ALUMINIUM
 ARANDELA EN ALUMINIO
 ARRUELA DE ALUMÍNIO

Code	Size	A	B	H	Pack.
01600 00 11 B5 00	M5	5.2	8	1	20
01600 00 11 02 00	1/8	10	14	1.5	20
01600 00 11 D7 00	M12	12.5	18	1.5	20
01600 00 11 03 00	1/4	13.5	18	1.5	20
01600 00 11 04 00	3/8	16.8	21	1.5	20
01600 00 11 05 00	1/2	21.1	26	1.5	20
01600 00 11 07 00	3/4	27.3	32	2.5	20
01600 00 11 09 00	1"	33.7	39.5	2.5	20

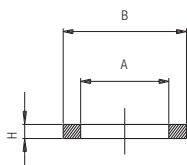

1610

RONDELLA DENTELLATA IN PA66

PA66 NOTCHED-WASHER
UNVERLIERBARE DICHTSCHEIBE AUS PA66
JOINT IMPERDABLE EN PA66
ARANDELA DENTADA EN NYLON PA66
ARRUELA DENTADA DE PA66

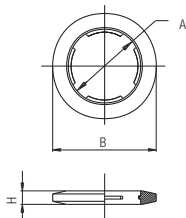

Code	Size	A	B	H	Pack.
01610 00 25 A7 00	M3	2.5	5.5	0.5	20
01610 00 25 B5 00	M5	5.1	8	1.3	20
01610 00 25 B8 00	M6	6.1	9	1.3	20
01610 00 25 02 00	1/8	9.8	14	1.8	20
01610 00 25 03 00	1/4	13.2	18	1.8	20
01610 00 25 04 00	3/8	16.6	21.9	1.6	20
01610 00 25 05 00	1/2	21	26	1.8	20
01610 00 25 07 00	3/4	26.5	33	2.5	20
01610 00 25 09 00	1"	33.3	41	2.5	20

	min	max
Temperature	- 20 °C	+ 90 °C

1612

RONDELLA BIMATERIALE IN ACCIAIO E NBR

STEEL AND NBR BIMATERIAL WASHER
BI-MATERIAL STAHL SCHEIBE UND NBR
JOINT BI-MATIÈRE - ACIER/NBR
ARANDELA BIMATERIAL EN ACERO Y NBR
ARRUELA BI-MATERIAL EM AÇO E NBR

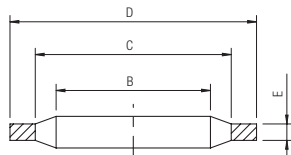

Code	Size	B	C	D	E	Pack.
01612 00 001	1/8	10.4	12	14.7	1.25	20
01612 00 002	1/4	13.85	15.75	18.7	1.25	20
01612 00 003	3/8	17.35	19.25	22.7	1.25	20
01612 00 004	1/2	21.65	23.55	26.7	1.25	20
01612 00 005	3/4	27.3	29.2	32.5	1.25	20
01612 00 006	1"	34.2	36.1	39.5	2	20

	min	max
Temperature	- 30 °C	+ 100 °C

1613

RONDELLA AUTOCENTRANTE BIMATERIALE IN ACCIAIO E NBR

STEEL AND NBR CENTERING BIMATERIAL WASHER
BI-MATERIAL STAHL SCHEIBE UND NBR
JOINT BI-MATIÈRE - ACIER/NBR
ARANDELA BIMATERIAL EN ACERO Y NBR
ARRUELA BI-MATERIAL EM AÇO E NBR

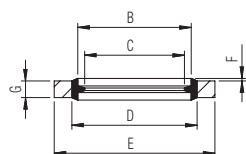

Code	Size	B	C	D	E	G	F	Pack.
01613 00 001	1/8	10.4	8.6	11.85	14	2	0.3	20
01613 00 002	1/4	13.75	11.45	15.2	17	2	0.3	20
01613 00 003	3/8	17.3	15	18.75	22	2	0.3	20
01613 00 004	1/2	21.55	18.65	23	26	2.5	0.4	20
01613 00 005	3/4	27.05	24.15	28.5	32	2.5	0.4	20
01613 00 006	1"	33.9	30.30	36.9	41	3.2	0.5	20

	min	max
Temperature	- 40 °C	+ 100 °C

1700

DADO DI BLOCCAGGIO

LOCKING NUT
 ÜBERWURFMUTTER
 ÉCROU
 TUERCA DE BLOCAJE
 PORCA DE TRAVAMENTO

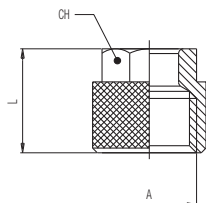

Code	Tube	A	L	CH	Pack.
01700 00 01 3Z NB	4/2.7	M6x0.5	9	7	50
01700 00 01 6Z NB	5/3	M7x0.75	11	8	50
01700 00 01 9Z NB	6/4	M8x0.75	11	8	50
01700 00 01 0X NB	6/4	M10x1	11	10	50
01700 00 01 4X NB	8/6	M12x1	11.5	12	50
01700 00 01 5X NB	10/8	M14x1	13.5	14	50
01700 00 01 6X NB	12/10	M16x1	15	15	50
01700 00 01 7X NB	15/12.5	M20x1	16	19	50

1710

DADO DI BLOCCAGGIO OTTONE CON MOLLA INOX

BRASS LOCKING NUT WITH STAINLESS STEEL SPRING
 MESSING ÜBERWURFMUTTER MIT KNICKSCHUTZFEDER EDELSTAHL
 ÉCROU LAITON AVEC RESSORT DE PROTECTION ACIER INOXYDABLE
 TUERCA DE BLOCAJE LATÓN CON MUELLE ACERO INOXIDABLE
 PORCA DE TRAVAMENTO LATÃO COM MOLA AÇO INOXIDÁVEL

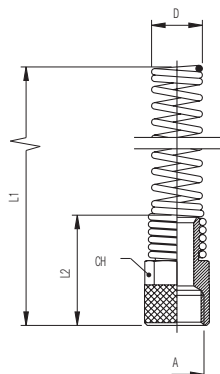

Code	Tube	A	D	L1	L2	CH	Pack.
01710 00 001	6/4	M10x1	9.4	93	20	11	20
01710 00 002	8/6	M12x1	11.4	98.5	21	13	20
01710 00 003	10/8	M14x1	13.4	107	24	14	20
01710 00 004	12/10	M16x1	16	116.5	27.5	17	20

Molla Acciaio Inox AISI 304 - EN 1.4301
 Stainless Steel Spring AISI 304 - EN 1.4301
 Edelstahlfeder AISI 304 - EN 1.4301
 Ressort Acier Inoxydable AISI 304 - EN 1.4301
 Muelle Acero Inoxidable AISI 304 - EN 1.4301
 Mola Aço Inoxidável AISI 304 - EN 1.4301

1750

TAGLIATUBO IN TECNOPOLIMERO

TECHNOPOLYMER PIPE CUTTER
 ROHRSCHEIDER KUNSTSTOFF
 COUPE TUBE POUR TUBE PLASTIQUE
 CORTATUBOS EN PLÁSTICO
 CORTADOR DE TUBO EM PLÁSTICO

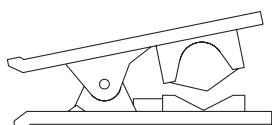

Code	Pack.
01750 00 001	10

8610

TAPPO IN POLIAMIDE

POLYAMIDE PLUG
 VERSCHLUSSZAPFEN POLYAMID
 BOUCHON EN POLYAMIDE
 TAPÓN EN POLIAMIDA
 TAMPÃO EM POLIAMIDA

Code	Tube	L	Pack.
08610 00 31 X1 RO	4	23.5	10
08610 00 31 X3 RO	5	24.5	10
08610 00 31 X4 RO	6	24.5	10
08610 00 31 X7 RO	8	26	10
08610 00 31 X9 RO	10	28.5	10
08610 00 31 Y1 RO	12	28.5	10

