

**RACCORDI AUTOMATICI, RACCORDI A FUNZIONE
VALVOLE A SFERA, ADATTATORI**

*PUSH-IN FITTINGS, FUNCTION FITTINGS
BALL VALVE, ADAPTERS*

*STECKVERSCHRAUBUNGEN, FUNKTIONSVERSCHRAUBUNGEN,
MAGNETVENTILE, ADAPTER*

*RACCORDS INSTANTANÉS, RACCORDS À FONCTIONS
OBINETS À BOISSEAU SPHÉRIQUE, ADAPTATEURS*

*RACORDAJE AUTOMÁTICO, RACORES A FUNCIONES
VÁLVULAS, ACCESORIOS*

*CONEXÕES PUSH-IN, CONEXÕES FUNCIONAIS
VÁLVULAS DE ESFERA, ACESSÓRIOS*

Serie 59000



COMPONENT



Aignep con la serie 59.000, nel rispetto della continua evoluzione normativa del settore alimentare, propone una gamma di prodotti certificati NSF 169, nonché alla 1935/2004/CE ed alla DM 174.

Questa serie realizzata con ottone a basso tenore di piombo CW510L è la risposta attuale e disponibile per tutti i clienti che hanno questa nuova e crescente esigenza.

Principali vantaggi

- NSF 169, 1935/2004/CE, DM 174
- Connessione e sconnessione istantanea
- Pieno passaggio e tenuta al vuoto grazie a guarnizioni sagomate
- Due tipologie di filettature, BSPP, BSPT
- Vasta gamma a disposizione per soddisfare le installazioni più esigenti
- Silicon Free

Applicazioni

- Industria agroalimentare
- Macchine per caffè e vending
- Food & Beverage
- Medica
- Vuoto

La série 59000 est le dernier développement spécifique pour le secteur Alimentaire & boisson. Les raccords sont certifiés NFS 169 à la norme alimentaire 1935/2004 / CE et Italienne DM 174. Cette gamme est conçue avec un laiton CW510L.

Principaux avantages

- NSF 169, 1935/2004 / CE, DM 174
- Connexion et déconnexion instantanée
- Plein débit et tenue au vide grâce à des joints de forme
- 2 filetages disponibles, BSPP, BSPT
- Large gamme pour répondre aux normes alimentaires
- Sans Silicone

Applications

- Industries agroalimentaire
- Machines à café
- Distributeurs de boisson
- Médical
- Vide

The 59.000 serie is the latest development in the Food&Beverage sector.

Fittings are certified NSF 169 standards and to the food norm 1935/2004/CE & Italian DM 174.

This line is made with a special Leadfree alloy CW510L.

Main advantages

- NSF 169, 1935/2004/CE, DM 174
- Quick connection and disconnection
- Full Flow and Vacuum resistant tank to special shaped seals
- 2 threads available, BSPP, BSPT (universal short)
- Large range to comply food norms
- Silicon Free

Applications

- Dairy
- Coffee Machines, Vending
- Food & Beverage
- Medical
- Vacuum

Aignep con la serie 59.000 Foods & Drinks, de acuerdo con la evolución de las normas cambiantes de la industria alimentaria, propone una gama de productos certificado NFS 169, así como la 1935/2004/CE y la DM 174.

Esta serie realizada en latón con bajo nivel de plomo CW510L es la respuesta actual y disponible para todos los clientes que tengan esta nueva y creciente exigencia.

Principales ventajas

- NSF 169, 1935/2004 / CE, DM 174
- Conexión y desconexión instantánea
- Paso total y estanqueidad al vacío gracias a las juntas moldeadas
- Dos tipos de roscas, BSPP, BSPT
- Amplia gama disponible para satisfacerlas instalaciones más exigentes
- Libre de silicona

Aplicaciones

- Industria agroalimentaria
- Maquinas de café y vending
- Alimentos y bebidas
- Medical
- Vacío

Die 59.000 Serie ist die neueste Entwicklung im Lebensmittel & Getränke Sektor.

Die Verschraubungen sind zertifiziert NSF 169 Normen und zu der Lebensmittelnorm 1935/2004/CE & Italian DM 174.

Diese Serie wird mit einer speziellen bleifreien Legierung CW510L gemacht.

Hauptvorteile

- NSF 169, 1935/2004/CE, DM 174
- Schnelle Verbindung und Trennung
- Voller Durchfluss und Vakuumfestigkeit, dank spezieller Formdichtungen
- Zwei Gewindearten, BSPP und BSPT
- Grosses Sortiment, welches die Lebensmittel-Normen erfüllt
- Silikonfrei

Anwendungen

- Milchprodukte
- Kaffeemaschinen und Automaten
- Lebensmittel & Getränke
- Pharmaindustrie
- Vakuum

A série 59.000 é o mais recente desenvolvimento da Aignep para o segmento de Alimentos e Bebidas. As conexões são fabricadas certificados NFS 169 com a norma 1935/2004/CE e também da norma italiana DM 174.

Esta linha é feita com uma liga especial sem presença de chumbo CW510L.

Principais vantagens

- NSF 169, 1935/2004/CE, DM 174
- Rápida conexão e desconexão.
- Vazão Total e resistência ao Vácuo graças ao design de suas vedações
- 2 threads available, BSPP, Métrica
- Alta vazão para atender às normas alimentícias
- Livre de Silicone

Aplicações

- Aplicações tradicionais
- Máquinas de café, vending machines
- Alimentícia e bebidas
- Médica
- Vácuo



CARATTERISTICHE TECNICHE

TECHNICAL CHARACTERISTICS
TECHNISCHE ANGABEN
CARACTÉRISTIQUES TECHNIQUES
CARACTERÍSTICAS TÉCNICAS
CARACTERÍSTICAS TÉCNICAS



Norma di Riferimento

Reference standard
Entspricht der Norm
Norme de référence
Normativa de referencia
Norma de referência

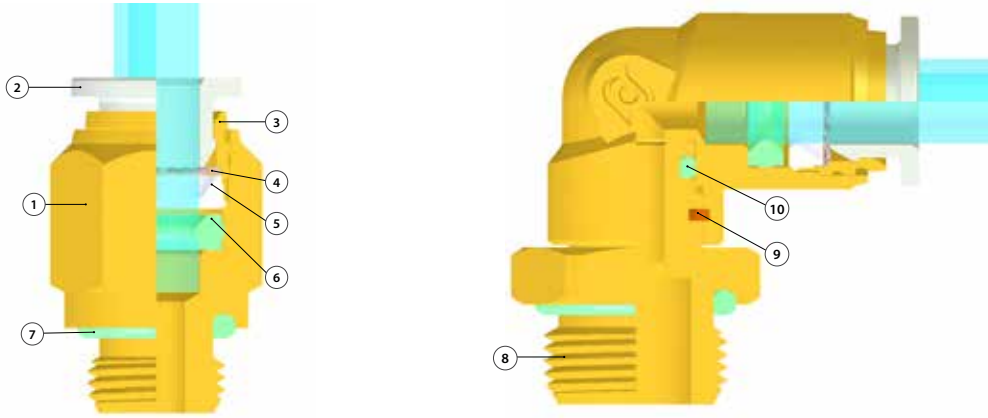

Materiali e Componenti	IT	Component Parts and Materials	GB	Komponenten und Materialien	DE
1 Corpo in Ottone CW510L		1 CW510L brass body		1 Körper Messing CW510L	
2 Spintore sgancio tubo PPSU		2 PPSU Collet		2 Druckring PPSU	
3 Capsula in ottone CW510L		3 CW510L brass capsule		3 Haltering Messing CW510L	
4 Pinza d'aggraffaggio in acciaio inox AISI 301		4 Steel AISI 301 clamping washer		4 Zahnscheibe Edelstahl AISI 301	
5 Anello di posizionamento PPSU		5 PPSU positioning ring		5 Positionierring PPSU	
6 Guarnizione sagomata in FKM Alimentare		6 Molded seal in FKM FOOD		6 Lippendichtung FKM Lebensmittelkonform	
7 Guarnizione O-ring FKM Alimentare		7 O-Ring seal in FKM Food		7 O-Ringdichtung FKM Lebensmittelkonform	
8 Basetta filettata in ottone CW510L		8 CW510L brass base threaded		8 Gewindebasis Messing CW510L	
9 Seeger		9 Seeger		9 Seeger	
10 Guarnizione FKM Alimentare		10 Seal in FKM Food		10 Lippendichtung FKM Lebensmittelkonform	

Matériaux et Composants	FR	Materiales y componentes	ES	Materiais e Componentes	PT
1 Corps en laiton CW510L		1 Cuerpo en latón CW510L		1 Corpo em latão CW510L	
2 Bouton poussoir : PPSU		2 Anillo extracción tubo en PPSU		2 Anilha de liberação de tubo em PPSU	
3 Capsule de retenue: laiton CW510L		3 Cápsula en latón CW510L		3 Cápsula em latão CW510L	
4 Rondelle d'accrochage en inox AISI 301		4 Pinza de agarre en acero inox AISI 301		4 Pinça de travamento em aço inoxidável AISI 301	
5 Anneau de positionnement PPSU		5 Anillo de posicionamiento en PPSU		5 Anel de posicionamento em PPSU	
6 Joint de forme en FKM qualité alimentaire		6 Junta de forma en FKM alimentario		6 Vedação moldada em FKM alimentício	
7 Joint O-ring FKM qualité alimentaire		7 Junta tórica en FKM alimentario		7 Vedação o-ring em FKM alimentício	
8 Bague de sécurité en laiton CW510L		8 Base roscada en latón CW510L		8 Base roscada em latão CW510L	
9 Seeger		9 Seeger		9 Seeger	
10 Joint FKM qualité alimentaire		10 Junta en FKM alimentaria		10 Vedação em FKM alimentício	



Pressioni

Pressures
Druckbereich
Pressions
Presiones
Pressões

- 0.99 bar (-0.099 MPa)
20 bar (2.0 MPa)



Temperature

Temperatures
Temperatur
Températures
Temperaturas
Temperaturas

- 15 °C
+ 190 °C



Fluidi compatibili

Aria compressa / Vuoto / Acqua / Alimenti
Vapore (Su richiesta in EPDM PX) Max 130°C.

Fluids

Compressed air / Vacuum / Water / Food
Steam (On request in EPDM PX) Max 130°C.

Geignete Medien

Druckluft / Vakuum / Wasser / Lebensmittel
Dampf (Auf Anfrage in EPDM PX) Max 130°C.

Fluides compatibles

Air comprimé / Vide / Eau / Boissons
Vapeur (Sur demande en EPDM PX) Max 130°C.

Fluidos compatibles

Aire comprimido / Vacío / Agua / Alimentos
Vapor (bajo pedido en EPDM PX) Max 130°C.

Fluidos compatíveis

Ar comprimido / Vácuo / Água / Alimentos
Vapor (A pedido em EPDM PX) Max 130°C.



IT Tubi di Collegamento	GB Connection Tubes	DE Geeignete Rohre
Tubi in materiale plastico: PA6, PA11, PA12, Polietilene, *Poliuretano, PTFE, FEP. *Utilizzo da 90 a 98 Shore, per la massima prestazione è consigliato 98 Shore A.	Plastic tubes: PA6, PA11, PA12, Polyethylene, *Polyurethane, PTFE, FEP. *Use from 90 to 98 Shore, for maximum performance is recommended 98 Shore A.	Kunststoffrohre: PA6, PA11, PA 12, Polyethylene, *Polyurethan, PTFE, FEP. *Verwenden Sie 90 bis 98 Shore, für maximale Leistung wird 98 Shore A empfohlen.
FR Tubes Conseillés	ES Tubos de Conexión	PT Tubos de Conexão
Tubes plastiques: PA6, PA11, PA12, Polyéthylène, *Polyuréthane, PTFE, FEP. *Utilisation de 90 à 98 Shore, pour une performance maximale recommandée 98 Shore A.	Tubos en material plástico: PA6, PA11, PA 12, Polietileno, *Poliuretano, PTFE, FEP. *Uso de 90 a 98 Shore, para un máximo rendimiento se recomienda 98 Shore A.	Tubos em material plástico: PA6, PA11, PA12, Polietileno, *Poliuretano, PTFE, FEP. *Uso de 90 a 98 Shore, para o desempenho máximo é recomendado 98 Shore A.



IT Filettatura	GB Threads	DE Gewindearten
Gas conica conforme ISO 7.1, BS 21, DIN 2999. Gas cilindrica conforme ISO 228 Classe A.	Tapered gas in conformity with ISO 7.1, BS 21, DIN 2999. Parallel gas in conformity with ISO 228 Class A.	Konisches Gewinde nach Norm ISO 7.1, BS 21, DIN 2999. Zylindrisches Gewinde nach Norm ISO 228 Classe A.
FR Filetages	ES Roscas	PT Roscas
Filetage conique conforme: ISO 7.1, BS 21, DIN 2999. Filetage cylindrique conforme: ISO 228 Classe A.	Gas cónica conforme ISO 7.1, BS 21, DIN 2999. Gas cilíndrica conforme ISO 228 Clase A.	Gas cônica conforme ISO 7.1, BS 21, DIN 2999. Gas paralela conforme ISO 228 Classe A.



Coppia di serraggio

Torque specifications

Angaben Drehmoment

Couple de serrage

Par de apriete

Especificações de Torque



ISO 228

I valori di rottura possono variare in base all'articolo
Breaking values may vary according to the item
Die maximal werte dienen nur zu informationszwecken
Les valeurs maximales sont présentées à titre indicatif
Los valores de rotura pueden variar en función del artículo
Os valores de ruptura podem variar em função do item

MISURA MEASURE GRÖSSE DIMENSIONS MEDIDA MEDIDA	COPPIA CONSIGLIATA Nm RECOMMENDED TORQUE Nm EMPFOHLENES DREHMOMENT Nm COUPLE DE SERRAGE Nm PAR ACONSEJADO Nm TORQUE RECOMENDADO Nm
1/8	3
1/4	9
3/8	10



Vantaggi	IT	Advantages	GB	Vorteile	DE
<p>1 La pinza in acciaio inox garantisce il perfetto aggraffaggio di tubi di qualsiasi materiale senza danneggiarne la superficie. Il collegamento tra tubo e raccordo assicura una tenuta totale anche in condizioni di urti e vibrazioni.</p> <p>2 La particolare geometria della guarnizione permette inoltre l'utilizzo dei raccordi anche con il vuoto.</p> <p>3 Tutte le filettature di questa serie sono state dotate di elementi di tenuta che permettono l'immediato utilizzo dei raccordi riducendo notevolmente i tempi di installazione.</p> <p>4 Raccordo orientabile con anello di sicurezza interno. Garantisce maggiore durata alla rotazione e trazione.</p>		<p>1 The washer is made in stainless steel ensures the perfect tube clamping with every kinds of materials without damage the surface. The connection between the tube and the fitting ensure a total tightness even in severe conditions such as impact and vibrations.</p> <p>2 The particular geometric shape of the seal ensure the perfect tightness even with vacuum.</p> <p>3 All of threads from this range have been equipped with tightening parts which allow the direct assembly of the fittings, reducing the installation time.</p> <p>4 Orienting fitting with safety ring inside. Improved durability to the rotation and traction.</p>		<p>1 Konisches Gewinde "kurz" Die Zahnscheibe sorgt für eine perfekte Halterung des Rohres ohne die Oberfläche zu beschädigen. Die Dichtheit zwischen Rohr und Verschraubung ist auch bei Erschütterungen und Vibrationen gewährleistet.</p> <p>2 Die besondere Geometrie der Dichtung ermöglicht auch die Anwendung der Verschraubungen in Verbindung mit Vakuum.</p> <p>3 Alle Verschraubungen in dieser Serie sind mit Gewindeabdichtungen ausgestattet, die den sofortigen Einsatz ermöglichen und daher die Montagezeit stark reduzieren.</p> <p>4 Flexible Montage mit Sicherungsring innen. Verbesserte Beständigkeit gegenüber der Drehung und Traktions.</p>	
<p>1 La rondelle en acier inoxydable garantit la parfaite tenue du tube quelle que soit la matière et sans l'endommager. La connexion entre le tube et le raccord assure une étanchéité totale même dans des conditions d'impact ou de vibrations.</p> <p>2 La spécificité géométrique du joint permet l'utilisation des raccords avec le vide.</p> <p>3 Tous les filetages de cette série sont équipés d'éléments d'étanchéité qui permettent l'utilisation immédiate des raccords réduisant ainsi le temps d'installation.</p> <p>4 Accessoire de fixation réglable avec anneau de sécurité à l'intérieur. Amélioration de la durée de la rotation et de traction.</p>	FR	<p>1 La pinza en acero inox garantiza el perfecto agarre del tubo de cualquier material sin perjudicar la superficie. La conexión entre tubo y racor asegura una estanqueidad total aun en condiciones de impacto o vibración.</p> <p>2 La particular geometría de la junta garantiza una perfecta estanqueidad incluso en vacío.</p> <p>3 Todas las rosas de esta serie están fabricadas con junta de cierre que permite la inmediata utilización del racor reduciendo notablemente el tiempo de instalación.</p> <p>4 Montaje ajustable con sistema de seguridad interior. La mejora de la durabilidad a la rotación y tracción.</p>	ES	<p>1 A pinça em aço-inox garante o perfeito travamento do tubo de qualquer material sem danificar a superfície do mesmo. A conexão entre o tubo e a conexão assegura uma vedação total também em condições de impactos e vibrações.</p> <p>2 A geometria particular da vedação permite a utilização da conexão também para aplicações com vácuo.</p> <p>3 Todas as rosas desta série são dotadas de elementos de vedação, o que permite a imediata utilização das conexões, reduzindo notavelmente o tempo de instalação.</p> <p>4 Montagem ajustável com anel de segurança dentro. A durabilidade melhorada para a rotação e tração.</p>	PT

59020

RACCORDO DIRITTO MASCHIO CILINDRICO

STRAIGHT MALE ADAPTOR (PARALLEL)
 GERADE EINSCHRAUBVERSCHRAUBUNG ZYLINDRISCH
 RACCORD DROIT MÂLE, CYLINDRIQUE
 RACOR RECTO MACHO CILÍNDRICO CON TÓRICA
 CONEXÃO RETA COM ROSCA PARALELA



Code	Tube	A	B	L	CH	Pack.
59020 00 002	4	1/8	5.4	20	10	50
59020 00 003	6	1/8	5.4	23.5	13	50
59020 00 004	6	1/4	7.1	23.5	13	50
59020 00 005	8	1/8	5.4	25	14	50
59020 00 006	8	1/4	7.1	22.5	14	50

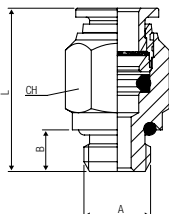

59030

RACCORDO DIRITTO FEMMINA

STRAIGHT FEMALE ADAPTOR
 AUFSCHRAUBVERSCHRAUBUNG
 RACCORD DROIT, TARAUDE
 RACOR RECTO HEMBRA
 CONEXÃO RETA COM ROSCA FÊMEA



Code	Tube	A	B	L	CH	Pack.
59030 00 001	4	1/8	8.5	23.5	13	50
59030 00 002	6	1/8	8.5	25	13	50
59030 00 003	6	1/4	11	29.5	16	50
59030 00 010	8	3/8	12	32	19	50

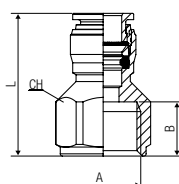

59040

RACCORDO DIRITTO INTERMEDIO

STRAIGHT CONNECTOR
 VERBINDUNGSVERSCHRAUBUNG
 RACCORD UNION DOUBLE
 RACOR RECTO INTERMEDIO
 CONEXÃO RETA TUBO-TUBO



Code	Tube	A	B	L	CH1	Pack.
59040 00 001	4	28.5	10.5	50	10	50
59040 00 003	6	32.5	12.5	50	13	50
59040 00 005	8	35	14.5	50	13	50

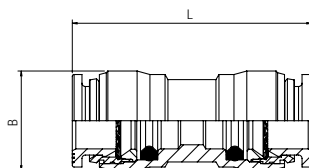

59100

RACCORDO A L MASCHIO CONICO

ELBOW MALE ADAPTOR (TAPER)

WINKELVERSCHRAUBUNG KONISCH

EQUERRE MÂLE CONIQUE

RACOR A L MACHO CÔNICO

CONEXÃO MACHO EM "L" COM ROSCA MACHO CÔNICA



COMPONENT

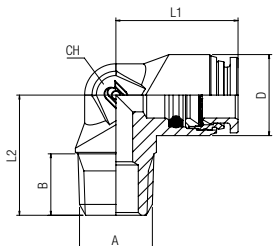

Code	Tube	A	B	L1	L2	CH	D	Pack.
59100 00 002	4	1/8	7.5	16.5	15.5	9	10	50
59100 00 003	6	1/8	7.5	20.5	17.5	11	12.5	50
59100 00 012	6	1/4	11	20.5	21.5	11	12.5	50
59100 00 005	8	1/4	11	21.5	22	13	14.5	50

59116

New

RACCORDO A L ORIENTABILE MASCHIO CILINDRICO

ORIENTING ELBOW MALE ADAPTOR (PARALLEL)

WINKELVERSCHRAUBUNG ZYLINDRISCH (DREHBAR)

EQUERRE ORIENTABLE MÂLE, CYLINDRIQUE

RACOR A L ORIENTABLE MACHO CILÍNDRICO CON TÓRICA

CONEXÃO MACHO EM "L" ORIENTÁVEL COM ROSCA PARALELA



COMPONENT

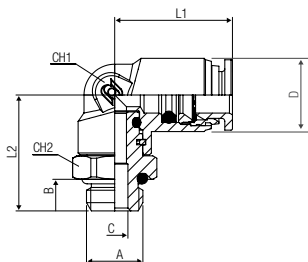

Code	Tube	A	B	C	L1	L2	CH1	CH2	D	Pack.
59116 00 003	4	1/8	5.4	4.5	17	18	9	13	10	50
59116 00 008	6	1/8	5.4	4.5	20.5	20	11	13	12.5	50
59116 00 009	6	1/4	7.1	4	20.5	21.5	11	16	12.5	50
59116 00 026	6	3/8	8.1	4	20.5	30	11	20	12.5	50
59116 00 010	8	1/8	5.4	5.5	22	22.5	12	13	14.5	50
59116 00 011	8	1/4	7.1	6	22.5	23	12	16	12.5	50
59116 00 012	8	3/8	8.1	6	22.5	25	12	20	12.5	50

59130

RACCORDO A L INTERMEDIO

ELBOW CONNECTOR

WINKELVERSCHRAUBUNG

RACCORD EQUERRE

RACOR A L INTERMEDIO

CONEXÃO EM "L" TUBO-TUBO



COMPONENT

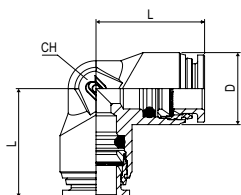

Code	Tube	L	CH	D	Pack.
59130 00 001	4	16.5	9	10	50
59130 00 002	6	20.5	11	12.5	50
59130 00 003	8	22	13	15	50

59216

RACCORDO A T ORIENTABILE MASCHIO CILINDRICO

ORIENTING TEE MALE ADAPTOR (PARALLEL)-CENTRE LEG
 T-EINSCHRAUBVERSCHRAUBUNG ZYLINDRISCH (DREHBAR)
 TÉ ORIENTABLE À PIQUAGE MÂLE CENTRAL, CYLINDRIQUE
 RACOR A T ORIENTABLE MACHO CENTRAL CILÍNDRICO CON TÓRICA
 CONEXÃO EM "T" ORIENTÁVEL COM ROSCA MACHO PARALELA



Code	Tube	A	B	L1	L2	CH1	CH2	D	Pack.
59216 00 003	4	1/8	5.4	32.5	18.5	9	13	10	50
59216 00 008	6	1/8	5.4	40.5	21.5	11	13	12.5	50
59216 00 009	6	1/4	7.1	40.5	21.5	11	16	12.5	50
59216 00 011	8	1/4	7.1	44	24	13	16	14.5	50
59216 00 012	8	3/8	8.1	44	26	13	20	14.5	50

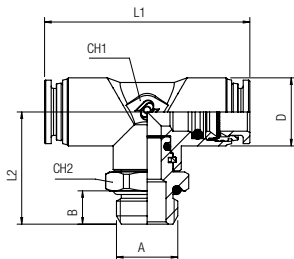

59226

RACCORDO A T ORIENTABILE MASCHIO LATERALE CILINDRICO

ORIENTING TEE MALE ADAPTOR (PARALLEL) - OFF - SET LEG
 L-EINSCHRAUBVERSCHRAUBUNG ZYLINDRISCH (DREHBAR)
 L-É ORIENTABLE À PIQUAGE LATÉRAL, CYLINDRIQUE
 RACOR A T ORIENTABLE MACHO LATERAL CILÍNDRICO CON TÓRICA
 CONEXÃO MACHO EM "T" LATERAL ORIENTÁVEL COM ROSCA PARALELA



Code	Tube	A	B	L1	L2	CH1	CH2	D	Pack.
59226 00 003	4	1/8	5.4	16.5	18.5	9	13	10	50
59226 00 008	6	1/8	5.4	20	20.5	11	13	12.5	50
59226 00 009	6	1/4	7.1	20	22	11	16	12.5	50
59226 00 011	8	1/4	7.1	22	23	13	16	14.5	50
59226 00 012	8	3/8	8.1	22	25	13	20	14.5	50

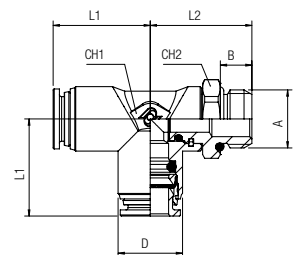

59230

RACCORDO A T INTERMEDIO

TEE CONNECTOR
 T-ANSCHLUSS
 RACCORD TÉ
 RACOR A T INTERMEDIO
 CONEXÃO EM "T" TUBO-TUBO



Code	Tube	L1	L2	CH	D	Pack.
59230 00 001	4	32.5	16.5	9	10	50
59230 00 002	6	40.5	20.5	11	12.5	50
59230 00 003	8	44	22	13	14.5	50

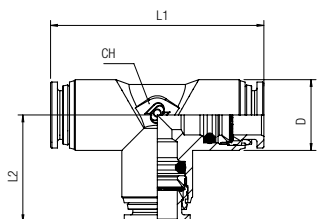

New

VALVOLA UNIDIREZIONALE O DI NON RITORNO - CW510L

UNIDIRECTIONAL VALVES OR NON RETURN VALVES - CW510L
 RÜCKSCHLAGVENTILE - CW510L
 CLAPET ANTI-RETOUR - CW510L
 VÁLVULAS UNIDIRECCIONALES O ANTIRETORNO - CW510L
 VÁLVULAS UNIDIRECIONAIS OU ANTI-RETORNO - CW510L



CARATTERISTICHE TECNICHE

TECHNICAL CHARACTERISTICS
 TECHNISCHE ANGABEN
 CARACTÉRISTIQUES TECHNIQUES
 CARACTERÍSTICAS TÉCNICAS
 CARACTERÍSTICAS TÉCNICAS



Norma di Riferimento

Reference standard
 Entspricht der Norm
 Norme de référence
 Normativa de referencia
 Norma de referência

1907/2006 REACH	2011/65/CE RoHS	M.O.C.A. 1935/2004 CE
PED 2014/68/UE	SILICON FREE	

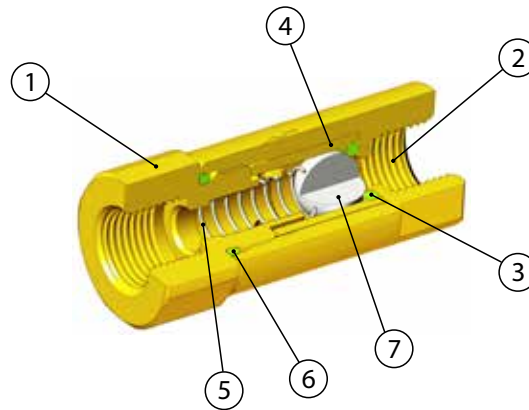
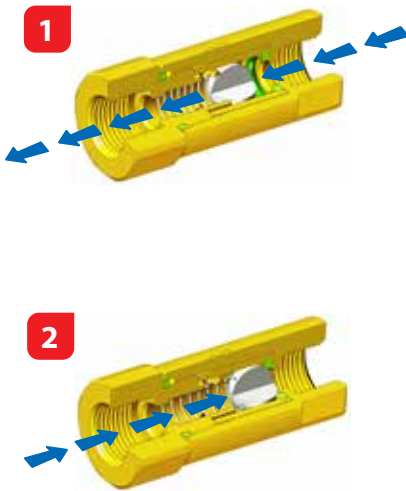

Materiali e Componenti	IT	Component Parts and Materials	GB	Komponenten und Materialien	DE
1 Corpo in Ottone CW510L		1 CW510L brass body		1 Körper Messing CW510L	
2 Attacco Terminale in ottone CW510L		2 CW510L Brass Valve Back Part		2 Ventilhinterteil Messing CW510L	
3 Guarnizione O-ring FKM Alimentare		3 O-Ring seal in FKM Food		3 O-Ringdichtung FKM lebensmittelkonform	
4 Bussola in ottone CW510L		4 CW510L Brass Compass		4 Kompass Messing CW510L	
5 Molla di mantenimento in acciaio AISI 302		5 Steel AISI 302 Keep spring		5 Feder Edelstahl AISI 302	
6 Guarnizione O-ring FKM Alimentare		6 O-Ring seal in FKM Food		6 O-Ringdichtung FKM lebensmittelkonform	
7 Sfera in acciaio AISI 420		7 AISI 420 steel ball		7 Kugel aus Stahl AISI 420	

Matériaux et Composants	FR	Materiales y Componentes	ES	Materiais e Componentes	PT
1 Corps en laiton CW510L		1 Cuerpo en latón CW510L		1 Corpo em latão CW510L	
2 Embase fileté: laiton CW510L		2 Parte posterior en latón CW510L		2 Parte traseira da válvula em Latão CW510L	
3 Joint O-ring FKM qualité alimentaire		3 Junta tórica en FKM alimentario		3 Vedação o-ring em FKM alimentício	
4 Boussole: Laiton CW510L		4 Brújula en latón CW510L		4 Bússola em Latão CW510L	
5 Ressort: acier inoxydable AISI 302		5 Muelle de mantenimiento en acero AISI 302		5 Mola de manutenção em aço AISI 302	
6 Joint O-ring FKM qualité alimentaire		6 Junta tórica en FKM alimentario		6 Vedação o-ring em FKM alimentício	
7 Bille en acier AISI 420		7 Bola de acero AISI 420		7 Esfera de aço AISI 420	



Filettatura	IT	Threads	GB	Gewindearten	DE
Gas cilindrica conforme ISO 228.		Parallel gas in conformity with ISO 228.		Zylindrisches Gewinde nach Norm ISO 228.	

Filetages	FR	Roscas	ES	Roscas	PT
Filetage cylindrique conforme: ISO 228.		Gas cilíndrica conforme ISO 228.		Gas paralela conforme ISO 228.	

IT	GB	DE
<p>Questo tipo di valvole permette il libero passaggio in un solo senso (quello indicato dalla freccia) e lo impedisce nel senso contrario.</p> <p>Azionate direttamente dal fluido che le attraversa, vengono normalmente impiegate come dispositivi di sicurezza, consentendo di mantenere in pressione una parte del circuito pur mandando a scarico l'alimentazione.</p>	<p>This kind of valves allow the free passage in only one direction, the one showed with the arrow marked on the body. They do not allow the passage on the opposite way, i.e. non return.</p> <p>They operate directly with the fluid that goes through, they are normally used as safety device, permitting to keep pressure in a part of the circuit, also when the feeding pressure has been taken off.</p>	<p>Diese Art von Ventilen erlaubt den freien Durchgang nur in eine Richtung, die mit dem Pfeil auf dem Gehäuse gekennzeichnet ist. Sie lassen den Durchgang in die entgegengesetzte Richtung nicht zu, d.h. ohne Rücklauf.</p> <p>Sie arbeiten direkt mit der durchfließenden Flüssigkeit, Sie werden normalerweise als Sicherheitsvorrichtung verwendet, die es ermöglichen, den Druck in einem Teil des Kreislaufs aufrechtzuerhalten, auch wenn der Speisedruck abgenommen wurde.</p>
FR	ES	PT
<p>Cette vanne permet le libre passage du fluide dans la direction marquée par la flèche indiquée sur le corps. Elle ne permet pas le passage en sens inverse.</p> <p>Elle est autonome et fonctionne directement avec le fluide qui la traverse. Elle est régulièrement utilisée comme dispositif de sécurité, permettant de maintenir la pression dans une partie du circuit lorsque la pression d'alimentation est coupée.</p>	<p>Este tipo de válvulas permiten el libre paso en un sólo sentido (indicado por la flecha en el cuerpo) y lo impide en el sentido contrario.</p> <p>Accionadas directamente por el fluido, vienen normalmente utilizadas como dispositivos de seguridad, consintiendo en mantener en presión una parte del circuito, incluso cuando no existe presión en la alimentación.</p>	<p>Este tipo de válvulas permite a liberação da passagem em apenas um sentido (aquele indicado pela seta) e impedir o fluxo no sentido contrário.</p> <p>Acionadas diretamente pelo ar que as atravessa, são normalmente aplicadas como dispositivos de segurança, permitindo a manutenção da pressão em uma parte do circuito mesmo quando a alimentação da pressão é retirada.</p>

Pressione Max

Max Pressures

Max Druckbereich

Pressions Max

Presiones Max

Pressões Max

8 bar (0.8 MPa)

Pressione minima di chiusura garantita

Guaranteed minimum closing pressure

Garantiertes minimaler Schließdruck

Pression de fermeture minimale garantie

Presión mínima garantizada de cierre

Pressão de fechamento mínima garantida

2 bar (0.2 MPa)

Pressione indicativa apertura

Approximate opening pressure

Öffnungsdruck

Pression d'ouverture

Presión indicativa de apertura

Pressão de abertura aproximada

0.2 bar (0.02 MPa)

Temperature

Temperatures

Temperatur

Températures

Temperaturas

Temperaturas

- 15 °C
+ 190 °C

Portata a scarico libero 6 bar

Exhaust Free flow rate 6 bar

Fluss Kostenlose Auspuff 6 bar

Débit échappement libre 6 bar

Caudal escape Libre 6 bar

Vazão descarga livre 6 bar

Ø 1/8	600 NI/min
Ø 1/4	625 NI/min

Fluidi compatibili

Aria compressa / Vuoto / Acqua / Alimenti

Fluids

Compressed air / Vacuum / Water / Food

Geeignete Medien

Druckluft / Vakuum / Wasser / Lebensmittel

Fluides compatibles

Air comprimé / Vide / Eau / Boissons

Fluidos compatibles

Aire comprimido / Vacío / Agua / Alimentos

Fluidos compatíveis

Ar comprimido / Vácuo / Água / Alimentos

6061

New 

VALVOLA UNIDIREZIONALE FEMMINA-FEMMINA

FEMALE-FEMALE NON RETURN VALVE
 RÜCKSCHLAGVENTIL INNEN- / INNENGEWINDE
 CLAPET ANTI-RETOUR, FEMELLE/FEMELLE
 VÁVULA UNIDIRECCIONAL HEMBRA-HEMBRA
 VÁLVULA UNIDIRECCIONAL FÊMEA-FÊMEA

Code	A	B	L	CH1	CH2	Pack.
06061 000 07 CW	1/8	8.5	41.5	17	14	25
06061 000 08 CW	1/4	11	48	20	17	25

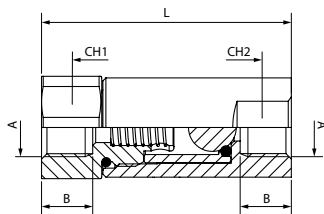

VALVOLE A SFERA - CW510L

CW510L - BALL VALVES
 KUGELHÄHNE - CW510L
 ROBINET A BOISSEAU SPHERIQUE - CW510L
 VÁLVULAS A ESFERA - CW510L
 VÁLVULAS DE ESFERA - CW510L



CARATTERISTICHE TECNICHE

TECHNICAL CHARACTERISTICS
 TECHNISCHE ANGABEN
 CARACTÉRISTIQUES TECHNIQUES
 CARACTERÍSTICAS TÉCNICAS
 CARACTERÍSTICAS TÉCNICAS

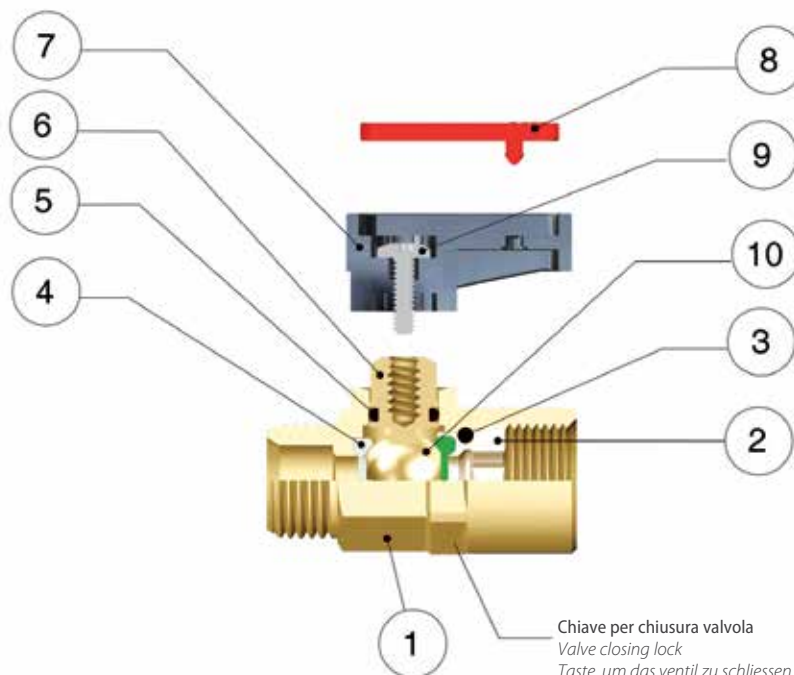

Chiave per chiusura valvola
 Valve closing lock
 Taste, um das Ventil zu schliessen
 Clé pour vanne de fermeture
 Llave para el cierre de la válvula
 A chave para o fecho da válvula



Norma di Riferimento

Reference Standard
 Entspricht Der Norm
 Conforme à La Norme
 Normativa de Referencia
 Norma de Referència

1907/2006 REACH ✓	2011/65/CE RoHS ✓	M.O.C.A. 1935/2004 CE
PED 2014/68/UE	SILICON FREE	

DIAGRAMMA PRESSIONE - TEMPERATURA

PRESSURE - TEMPERATURE RATINGS DIAGRAM
 DRUCK - TEMPERATUR DIAGRAMM
 DIAGRAMME PRESSION - TEMPÉRATURE
 DIAGRAMA PRESIÓN-TEMPERATURA
 DIAGRAMA DE PRESSÃO-TEMPERATURA

PTFE + FKM



Temperature

Temperatures
 Temperatur
 Températures
 Temperaturas
 Temperaturas

FKM
 - 15 °C
 + 130 °C

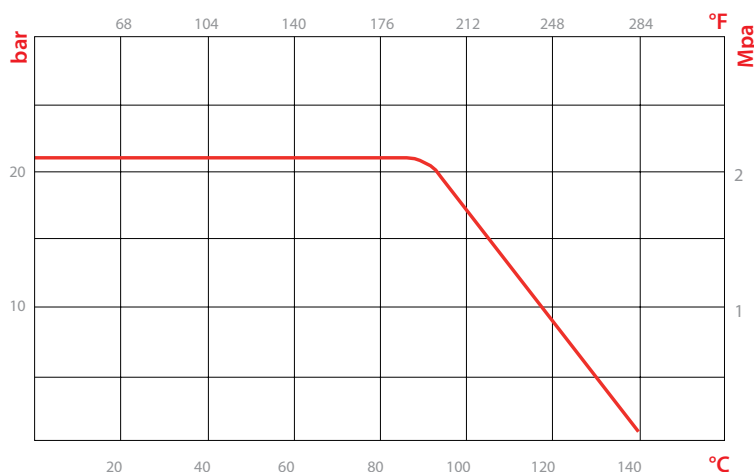



Pressioni

Pressures

Druckbereich

Pressions

Presiones

Pressões

-0.99 bar (-0.099 MPa)

20 bar (2 MPa)



Fluidi compatibili

Aria compressa / Vuoto / Acqua / Alimenti

Fluids

Compressed air / Vacuum / Water / Food

Geeignete Medien

Druckluft / Vakuum / Wasser / Lebensmittel

Fluides compatibles

Air comprimé / Vide / Eau / Boissons

Fluidos compatibles

Aire comprimido / Vacío / Agua / Alimentos

Fluidos compatíveis

Ar comprimido / Vácuo / Água / Alimentos

Materiali e Componenti	IT	Component Parts and Materials	GB	Komponenten und Materialien	DE
1 Corpo in Ottone CW510L		1 CW510L brass body		1 Körper Messing CW510L	
2 Ghiera o raccordo in Ottone CW510L		2 CW510L Brass Fitting		2 Gewindeinsatz Messing CW510L	
3 Guarnizione O-ring FKM Alimentare		3 O-Ring seal in FKM Food		3 O-Ringdichtung FKM lebensmittelkonform	
4 Guarnizione sede sfera in PTFE		4 PTFE Seats		4 Kugelsitzdichtung PTFE	
5 Guarnizione O-ring FKM Alimentare		5 O-Ring seal in FKM Food		5 O-Ringdichtung FKM lebensmittelkonform	
6 Albero in Ottone CW510L		6 CW510L Brass Spindle		6 Spindel Messing CW510L	
7 Maniglietta in PA66 Caricato vetro		7 PA66 Glass reinforced Handle		7 Handgriff PA66 Glasfaser verstärkt	
8 Piastrina in Resina Acetalica		8 Acetalic resin Plate		8 Griffplatte Acetal	
9 Vite in acciaio		9 Steel Screw		9 Schraube Stahl	
10 Sfera in Ottone CW510L		10 CW510L Nickel-plated Brass Ball		10 Kugel Messing CW510L	

Matériaux et Composants	FR	Materiales y Componentes	ES	Materiais e Componentes	PT
1 Corps en laiton CW510L		1 Cuerpo en latón CW510L		1 Corpo em latão CW510L	
2 Ecrou de blocage: laiton CW510L		2 Racor en latón CW510L		2 Conexões em Latão CW510L	
3 Joint O-ring FKM qualité alimentaire		3 Junta tórica en FKM alimentario		3 Vedação o-ring em FKM alimentício	
4 Joint bille sphérique: PTFE		4 Junta sede esfera en PTFE		4 Vedação da sede da esfera em PTFE	
5 Joint O-ring FKM qualité alimentaire		5 Junta tórica en FKM alimentario		5 Vedação o-ring em FKM alimentício	
6 Tige: laiton CW510L		6 Eje en latón CW510L		6 Eixo em Latão CW510L	
7 Poignée en PA66 chargé en fibre de verre		7 Maneta en PA66 con fibra de vidrio		7 Manopla em PA66 e fibra de vidro	
8 Plaquette de poignée: résine acétal		8 Plaqueta en PA6		8 Piaqueta de Resina Acetalica	
9 Vis: acier		9 Tornillo en acero		9 Parafuso em aço	
10 Bille: laiton CW510L		10 Esfera en latón CW510L		10 Esfera em Latão CW510L	



Filettatura	IT	Threads	GB	Gewindearten	DE
Gas conforme ISO 7.1, BS 21, DIN 2999		Gas in conformity with ISO7.1, BS 21, DIN 2999.		Gewinde nach Norm ISO 7.1, BS 21, DIN 2999.	

Filetages	FR	Roscas	ES	Roscas	PT
Filetage conforme: ISO7.1, BS 21, DIN 2999.		Gas conforme ISO 7.1, BS 21, DIN 2999		Gas conforme ISO 7.1, BS 21, DIN 2999.	

6315

VALVOLA MASCHIO CONICO R ISO 7 - FEMMINA RP ISO 7

TAPER MALE R ISO 7 - FEMALE RP ISO 7 VALVE

KUGELHAHN AUSSENGEW. KONISCH R ISO 7 - INNENGEW. RP ISO 7

ROBINET FILETAGE R ISO 7 - TARAUDAGE RP ISO 7

VÁLVULA MACHO CÓNICO R ISO 7 - HEMBRA RP ISO 7

VÁLVULA ROSCA MACHO CÓNICA R ISO 7 - ROSCA FÊMEA RP ISO 7



Code	A	B	DN	ES	F	M	L	G	H	Pack.
06315 000 01 CW	1/8	1/8	6	14-15	7.4	7.4	36	19	21	25
06315 000 03 CW	1/4	1/4	6	14-15	11	11	43	19	21	25

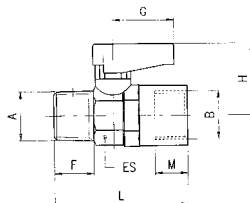

REGOLATORE DI PORTATA ORIENTABILE - CW510L

CW510L - ORIENTING FLOW REGULATOR
 DURCHFLUSSREGLER (DREHBAR) - CW510L
 RÉGLEURS DE DÉBIT ORIENTABLES - CW510L
 REGULADORES DE CAUDAL ORIENTABLES - CW510L
 REGULADORAS DE VAZÃO ORIENTÁVELV - CW510L



CARATTERISTICHE TECNICHE

TECHNICAL CHARACTERISTICS
 TECHNISCHE ANGABEN
 CARACTÉRISTIQUES TECHNIQUES
 CARACTERÍSTICAS TÉCNICAS
 CARACTERÍSTICAS TÉCNICAS



Norma di Riferimento

Reference Standard
 Entspricht Der Norm
 Conforme à La Norme
 Normativa de Referencia
 Norma de Referência

1907/2006 REACH ✓	2011/65/CE RoHS ✓	M.O.C.A. 1935/2004 CE
PED 2014/68/UE	SILICON FREE	



Pressioni

Pressures
 Druckbereich
 Pressions
 Presiones
 Pressões

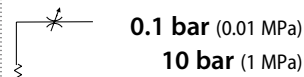

Temperature

Temperatures
 Temperatur
 Températures
 Temperaturas
 Temperaturas

- 15 °C
+ 190 °C



Fluidi compatibili

Aria compressa / Vuoto / Acqua / Alimenti
 Fluids
 Compressed air / Vacuum / Water / Food
 Geeignete Medien
 Druckluft / Vakuum / Wasser / Lebensmittel
 Fluides compatibles
 Air comprimé / Vide / Eau / Boissons
 Fluidos compatibles
 Aire comprimido / Vacío / Agua / Alimentos
 Fluidos compatíveis
 Ar comprimido / Vácuo / Água / Alimentos

Materiali e Componenti	IT	Component Parts and Materials	GB	Komponenten und Materialien	DE
1 Corpo in Ottone CW510L		1 CW510L brass body		1 Körper Messing CW510L	
2 Spillo di Regolazione in Ottone CW510L		2 CW510L Brass Adjusting needle		2 Einstellnadel Messing CW510L	
3 Guarnizione O-ring FKM Alimentare		3 O-Ring seal in FKM Food		3 O-Ringdichtung FKM lebensmittelkonform	

Matériaux et Composants	FR	Materiales y componentes	ES	Materiais e Componentes	PT
1 Corps en laiton CW510L		1 Cuerpo en latón CW510L		1 Corpo em latão CW510L	
2 Vis de réglage: laiton CW510L		2 Tornillo de regulación en latón CW510L		2 Agulha de Regulagem em Latão CW510L	
3 Joint O-ring FKM qualité alimentaire		3 Junta tórica en FKM alimentario		3 Vedação o-ring em FKM alimentício	



Filettatura Gas cilindrica conforme ISO 228 Classe A.	IT	Threads Parallel gas in conformity with ISO 228 Class A.	GB	Gewindearten Zylindrisches Gewinde nach Norm ISO 228 Classe A.	DE
Filetages Filetage cylindrique conforme: ISO 228 Class A.	FR	Roscas Gas cilíndrica conforme ISO 228 Clase A.	ES	Roscas Gas paralela conforme ISO 228 Classe A.	PT

6924

REGOLATORE DI FLUSSO BIDIREZIONALE

BI-DIRECTIONAL FLOW REGULATOR
 DURCHFLUSSREGLER BI-DIREKTIONAL
 VIS RÉGLEUR DE DÉBIT BI-DIRECTIONNEL
 TORNILLO REGULADOR BIDIRECCIONAL
 REGULADORA DE VAZÃO BI-DIRECIONAL



Code	A	C	B	L1	L2	CH	D	Pack.
06924 000 02 CW	1/4	1/4	7.1	22	39	17	16.5	25

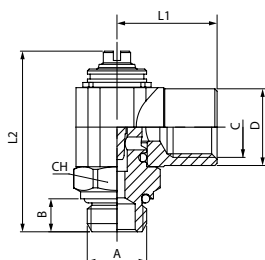

RACCORDI FILETTATI - CW510L

CW510L - BRASS ADAPTORS
 GEWINDEVERSCHRAUBUNGEN - CW510L
 ACCESSOIRES DE RACCORDEMENT - CW510L
 RACORDAJE ROSCADO - CW510L
 ACESSÓRIOS ROSCADOS - CW510L



CARATTERISTICHE TECNICHE

TECHNICAL CHARACTERISTICS
 TECHNISCHE ANGABEN
 CARACTÉRISTIQUES TECHNIQUES
 CARACTERÍSTICAS TÉCNICAS
 CARACTERÍSTICAS TÉCNICAS



Norma di Riferimento

- Reference standard
- Entspricht der Norm
- Norme de référence
- Normativa de referencia
- Norma de referència

1907/2006 REACH ✓	2011/65/CE RoHS ✓	M.O.C.A. 1935/2004 CE
PED 2014/68/UE	SILICON FREE	

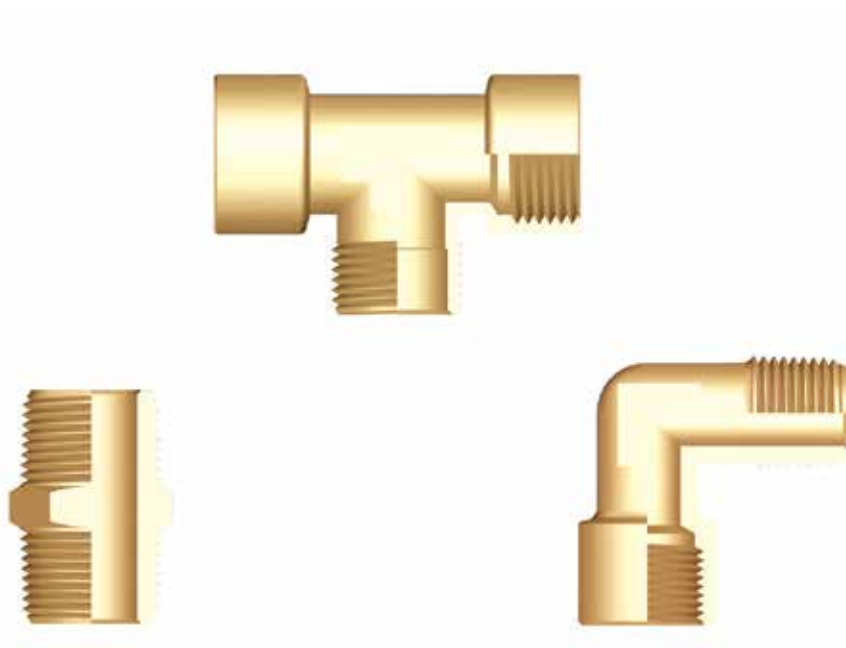

Materiali e Componenti

La maggior parte degli articoli di questa serie é composta da un unico particolare in CW 510L

IT

Component Parts and Materials

The main part of these fittings is made in CW 510L

GB

Komponenten und Materialien

Die meisten Artikel in dieser Serie werden aus CW 510L

DE

Matériaux et Composants

La majeure partie des raccords de ce chapitre est fabriquée en laiton CW 510L

FR

Materiales y Componentes

La mayor parte de los artículos de esta serie está compuesta de un solo material latón CW 510L

ES

Materiais e Componentes

A maior parte dos itens desta série é fabricada em CW 510L

PT



Misura
 Size
 Grösse
 Dimensions
 Medida
 Tamanho

Pressione consigliata
 Pressure advised
 Empfohlener druck
 Empfohlener druck
 Pression conseillée
 Presión recomendada
 Pressão aconselhada



1/8	-0.99 bar ~ 150 bar
1/4	-0.99 bar ~ 100 bar



Temperature massima

Maximum temperature
 Maximum temperatur
 Température maximale
 Temperatura máxima
 Temperatura máxima

+ 300 °C



Fluidi compatibili

Aria compressa / Vuoto / Acqua / Vapore / Alimenti

Fluids

Compressed air / Vacuum / Water / Steam / Food

Geeignete Medien

Druckluft / Vakuum / Wasser / Dampf / Lebensmittel

Fluides compatibles

Air comprimé / Vide / Eau / Vapeur / Boissons

Fluidos compatibles

Aire comprimido / Vacío / Agua / Vapor / Alimentos

Fluidos compatíveis

Ar comprimido / Vácuo / Água / Vapor / Alimentos



Tubi di Collegamento

Tubi e raccordi in genere.

IT

Connection Tubes

Tubes and fittings in general.

GB

Geeignete Rohre

Rohre und Verschraubungen im Allgemeinen.

DE

Tubes Conseillés

Raccords et tubes compatibles.

FR

Tubos de Conexión

Tubo y racordaje en general.

ES

Tubos de Conexão

Tubos e conexões em geral.

PT



Filettatura

Gas conica conforme ISO 7.1, BS 21, DIN 2999.
Gas cilindrica conforme ISO 228 Classe A.

IT

Threads

Tapered gas in conformity with ISO 7.1, BS 21, DIN 2999.
Parallel gas in conformity with ISO 228 Class A.

GB

Gewindearten

Konisches Gewinde nach Norm ISO 7.1, BS 21, DIN 2999.
Zylindrisches Gewinde nach Norm ISO 228 Classe A.

DE

Filetages

Filetage conique conforme: ISO 7.1, BS 21, DIN 2999.
Filetage cylindrique conforme: ISO 228 Classe A.

FR

Roscas

Gas cónica conforme ISO 7.1, BS 21, DIN 2999.
Gas cilíndrica conforme ISO 228 Clase A.

ES

Roscas

Gas cónica conforme ISO 7.1, BS 21, DIN 2999.
Gas paralela conforme ISO 228 Classe A.

PT

2000

NIPPLO CONICO

NIPPLE (TAPER)

DOPPELNIPPEL KONISCH

MAMELON DOUBLE CONIQUE

MACHÓN CÓNICO

NIPLE COM ROSCA CÓNICA



Code	A	B	L	CH	Pack.
02000 00 89 02 00	1/8	7.5	19.5	12	50
02000 00 89 03 00	1/4	11	27	14	50

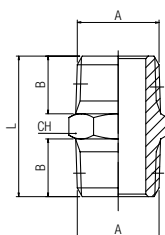

2020

NIPLO DI RIDUZIONE CONICO

REDUCING NIPPLE (TAPER)
 DOPPELNIPPEL REDUZIERT KONISCH
 MAMELON DOUBLE INÉGAL, CONIQUE
 MACHÓN CÓNICO DE REDUCCIÓN
 NIPLE DE REDUÇÃO COM ROSCA CÔNICA

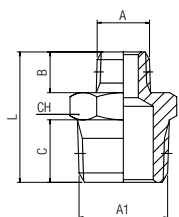

Code	A	A1	B	C	L	CH	Pack.
02020 00 89 AT 00	1/8	1/4	7.5	11	23.5	14	50

3000

MANICOTTO

SLEEVE
 MUFFE
 MANCHON
 MANGUITO
 LUVA

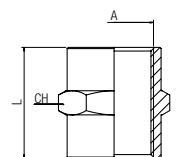

Code	A	L	CH	Pack.
03000 00 89 02 00	1/8	15	14	50
03000 00 89 03 00	1/4	22	17	50

4000

RACCORDO A T FEMMINA

FEMALE TEE
 T-VERSCHRAUBUNG INNENGEW.
 TÉ ÉGAL FEMELLE
 RACOR A T HEMBRA
 CONEXÃO EM "T" COM ROSCA FÊMEA

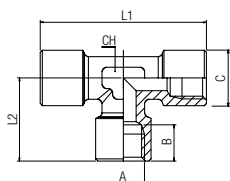

Code	A	B	L2	L1	C	CH	Pack.
04000 00 89 02 00	1/8	8.5	19.5	39	13	12	50
04000 00 89 03 00	1/4	11	24.5	49	16.5	13	25

4040

RACCORDO A T MASCHIO CENTRALE

CENTRE LEG MALE TEE
 T-VERSCHRAUBUNG AUSSENGEW. MITTIG
 TÉ ÉGAL FEMELLE, CENTRE MÂLE
 RACOR A T MACHO CENTRAL
 CONEXÃO EM "T" COM ROSCA MACHO CENTRAL

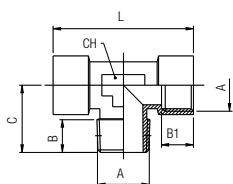

Code	A	B	B1	C	L	CH	Pack.
04040 00 89 02 00	1/8	8	8.5	17.5	39	12	50
04040 00 89 03 00	1/4	11	11	23	49	13	25

4050

RACCORDO A T MASCHIO LATERALE

OFF SET MALE TEE
 T-VERSCHRAUBUNG AUSSENGEW. SEITLICH
 TÉ ÉGAL FEMELLE, EN BOUT MÂLE
 RACOR A T MACHO LATERAL
 CONEXÃO EM "T" COM ROSCA MACHO LATERAL

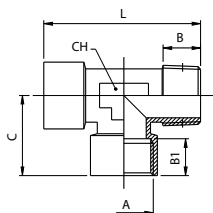

Code	A	B	B1	C	L	CH	Pack.
04050 00 89 02 00	1/8	8	8.5	19.5	37	12	50
04050 00 89 03 00	1/4	11	11	24.5	47.5	13	25

5000

RACCORDO A L MASCHIO

MALE ELBOW
 WINKELVERSCHRAUBUNG AUSSENGEW.
 EQUERRE MÂLE
 RACOR A L MACHO
 CONEXÃO EM "L" COM ROSCA MACHO

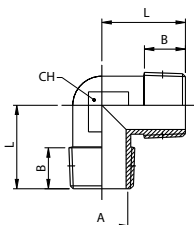

Code	A	B	L	CH	Pack.
05000 00 89 02 00	1/8	7.5	18	11	50
05000 00 89 03 00	1/4	11	24	13	25

5010

RACCORDO A L FEMMINA

FEMALE ELBOW
 WINKELVERSCHRAUBUNG INNENGEW.
 EQUERRE FEMELLE
 RACOR A L HEMBRA
 CONEXÃO EM "L" COM ROSCA FÊMEA

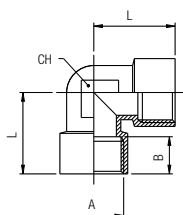

Code	A	B	L	CH	Pack.
05010 00 89 02 00	1/8	8.5	21	11	50
05010 00 89 03 00	1/4	11	25.5	13	25

5020

RACCORDO A L MASCHIO-FEMMINA

MALE-FEMALE ELBOW
 WINKELVERSCHRAUBUNG AUSSEN-/INNENGEW.
 EQUERRE MÂLE-FEMELLE
 RACOR A L MACHO - HEMBRA
 CONEXÃO EM "L" MACHO-FÊMEA

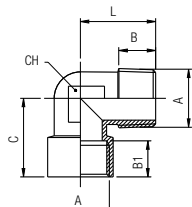

Code	A	B	B1	C	L	CH	Pack.
05020 00 89 02 00	1/8	7.5	8.5	21	18	11	50
05020 00 89 03 00	1/4	11	11	25.5	24	13	25

ARTICOLI DISPONIBILI A RICHIESTA

ARTICLES AVAILABLE ON REQUEST
ARTIKEL ERHÄLTICH AUF ANFRAGE
ARTICLES DISPONIBLES SUR DEMANDE
ARTICULOS DISPONIBLES BAJO DEMANDA
ITENS DISPONÍVEIS SOB ENCOMENDA

1 SERIE 1000 - CW510L**2 SERIE 13000 - CW510L**