

**SERIE 130 UNI ISO 6150 B-15**



**CARATTERISTICHE TECNICHE**  
 TECHNICAL CHARACTERISTICS  
 TECHNISCHE ANGABEN  
 CARACTÉRISTIQUES TECHNIQUES  
 CARACTERÍSTICAS TÉCNICAS  
 CARACTERÍSTICAS TÉCNICAS



**Norma di Riferimento**  
 Reference standard  
 Entspricht der Norm  
 Norme de référence  
 Normativa de referencia  
 Norma de referência

1907/2006  
**REACH** ✓

2011/65/CE  
**RoHS** ✓

PED  
 2014/68/UE

**SILICON  
 FREE**

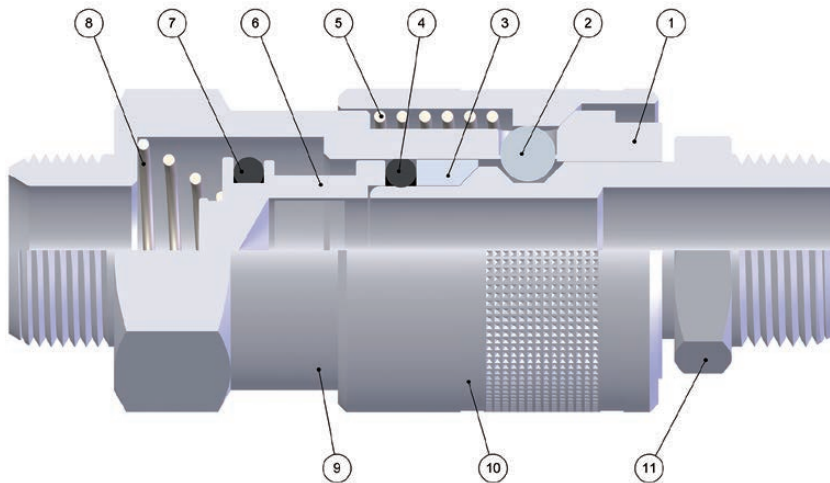

**FKM A RICHIESTA**  
 IF REQUESTED FKM  
 FKM AUF ANFRAGE  
 FKM SUR DEMANDE  
 FKM BAJO DEMANDA  
 FKM SOB ENCOMENDA

DN  
**9 mm**

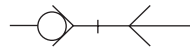

**UNI ISO 6150 B-15**

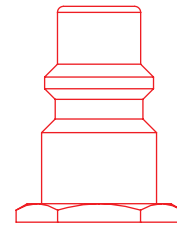

**1:1**

Materiali e Componenti	IT	Component Parts and Materials	GB	Komponenten und Materialien	DE
1 Corpo in Ottone Nichelato		1 Nickel-Plated Brass Body		1 Körper Messing Vernickelt	
2 Sfera in Acciaio AISI 420		2 Stainless Steel AISI 420 Balls		2 Kugel Edelstahl AISI 420	
3 Anello Guida Innesto in Ottone Nichelato		3 Nickel-Plated Brass Guide Ring Coupling		3 Stecker Führungsring Messing Vernickelt	
4 Guarnizione O-Ring in NBR		4 NBR O-Ring Seals		4 O-Ring NBR	
5 Molla Ghiera in Acciaio AISI 302		5 Stainless Steel AISI 302 Ring Nut Spring		5 Entriegelungsfeder Edelstahl AISI 302	
6 Otturatore in Ottone Nichelato		6 Nickel-Plated Brass Shutter		6 Verschluss Messing Vernickelt	
7 Guarnizione O-Ring in NBR		7 NBR O-Ring Seals		7 O-Ring NBR	
8 Molla Otturatore in Acciaio AISI 302		8 Stainless Steel AISI 302 Shutter Spring		8 Verschlussfeder Edelstahl AISI 302	
9 Attacco Terminale in Ottone Nichelato		9 Nickel-Plated Brass Coupling Back Part		9 Einschraubkörper Messing Vernickelt	
10 Ghiera in Ottone Nichelato		10 Nickel-Plated Brass Sleeve		10 Entriegelungshülse Messing Vernickelt	
11 Innesto in Ottone Nichelato		11 Nickel-Plated Brass Plug Outline		11 Stecker Messing Vernickelt	

Matériaux et Composants	FR	Materiales y Componentes	ES	Materiais e Componentes	PT
1 Corps: Laiton Nickelé		1 Cuerpo en latón niquelado		1 Corpo em Latão Niquelado	
2 Bille: Acier Inoxydable AISI 420		2 Esfera en acero AISI 420		2 Esfera em aço AISI 420	
3 Bague de Guidage: Laiton Nickelé		3 Anillo guía enchufe en latón niquelado		3 Anel guia do plug em latão niquelado	
4 Joint Torique en NBR		4 Junta tórica en NBR		4 Vedação O-Ring em NBR	
5 Ressort de Bague: Acier Inoxydable AISI 302		5 Muelle tuerca en acero AISI 302		5 Mola da porca em aço AISI 302	
6 Clapet: Laiton Nickelé		6 Obturador en latón niquelado		6 Obturador em latão niquelado	
7 Joint Torique en NBR		7 Junta tórica en NBR		7 Vedação O-Ring em NBR	
8 Ressort de Clapet: Acier Inoxydable AISI 302		8 Muelle obturador en acero AISI 302		8 Mola do obturador em aço AISI 302	
9 Corps: Laiton Nickelé		9 Terminal de conexión en latón niquelado		9 Conexão terminal em latão niquelado	
10 Bague: Laiton Nickelé		10 Tuerca en latón niquelado		10 Porca em latão niquelado	
11 Embout: Laiton Nickelé		11 Enchufe en latón niquelado		11 Plug em latão niquelado	



### Pressione d'esercizio

Working Pressures

Betriebsdruck

Pression de service

Presión de Ejercicio

Pressão de Trabalho

**0 bar**

**16 bar**



### Max pressione statica (no pulsazioni)

Maximum static pressure (no pulsations)

Maximaler statischer Betriebsdruck (ohne pulsations)

Pression statique maximale (sans pulsation)

Presión estática máxima (sin pulsaciones)

Pressão estática máxima (sem pulsações)

**35 bar**



### Temperature

Temperatures

Temperatur

Températures

Temperaturas

Temperaturas

**- 20 °C**

**+ 80 °C**

Con O-ring in FKM

With FKM O-ring

Mit O-ring in FKM

Avec joints en FKM

Con junta tórica en FKM

Com O-ring em FKM

**- 10 °C**

**+ 200 °C**



### Fluidi compatibili

Aria compressa

Fluids

Compressed air

Geeignete Medien

Druckluft

Fluides compatibles

Air comprimé

Fluidos compatibles

Aire comprimido

Fluidos compatíveis

Ar comprimido

Per altri fluidi, consultare l'ufficio tecnico Aignep.

For other fluids, consult the technical department Aignep.

Für andere Flüssigkeiten, kontaktieren Sie uns.

Pour d'autres fluides, veuillez nous consulter.

Para otros fluidos póngase en contacto con el departamento técnico Aignep.

Para outros fluidos consulte o departamento técnico da Aignep.



### Portata

NI/min

Flow Rate

Durchflusswerte

Débit

Caudal de Flujo

Vazão

6 bar Δ 1	6 bar Δ 0.5	6 bar *
2500	2050	3300

\* Scarico libero - Exhaust Free - Freier Auslass - Échappement libre - Escape Libre - Descarga libre.



### Filettatura

IT

### Threads

GB

### Gewindearten

DE

Gas cilindrica conforme ISO 228 Classe A.

Parallel gas in conformity with ISO 228 Class A.

Zylindrisches Gewinde nach Norm ISO 228 Classe A.

### Filetages

FR

### Roscas

ES

### Roscas

PT

Filetage cylindrique conforme: ISO 228 Class A.

Gas cilíndrica conforme ISO 228 Clase A.

Gas paralela conforme ISO 228 Classe A.

# 131

**PRESA MASCHIO**

MALE SOCKET  
 VERSCHLUSS-KUPPLUNG MIT AUSSENGEWINDE  
 COUPLEUR MÂLE  
 ENCHUFE MACHO  
 SOQUETE COM ROSCA MACHO

Code	A	B	C	D	CH	Pack.
00131 00 001	3/8	9	56	28	24	10
00131 00 002	1/2	10	56	28	24	10

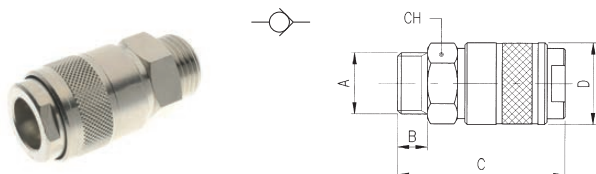

# 132

**PRESA FEMMINA**

FEMALE SOCKET  
 VERSCHLUSS-KUPPLUNG MIT INNENGEWINDE  
 COUPLEUR FEMELLE  
 ENCHUFE HEMBRA  
 SOQUETE COM ROSCA FÊMEA

Code	A	B	C	D	CH	Pack.
00132 00 001	3/8	11.5	56.5	28	24	10
00132 00 002	1/2	14	59	28	24	10

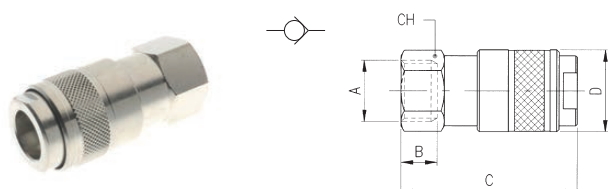

# 133

**PRESA A CALZAMENTO CON MOLLA**

COMPRESSION SOCKET WITH SPRING  
 VERSCHLUSS-KUPPLUNG MIT KNICKSCHUTZFEDER  
 COUPLEUR AVEC RESSORT DE PROTECTION  
 ENCHUFE TUBO CON MUELLE  
 SOQUETE COM CONEXÃO PUSH-ON COM MOLLA

Code	A	C	D	CH	Pack.
00133 00 001	10/8	155	28	24	10
00133 00 002	12/10	162.5	28	24	10

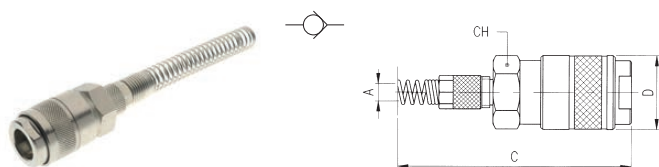

Molla Acciaio Inox AISI 304 - EN 1.4301  
 Stainless Steel Spring AISI 304 - EN 1.4301  
 Edelstahlfeder AISI 304 - EN 1.4301  
 Ressort Acier Inoxydable AISI 304 - EN 1.4301  
 Muelle Acero Inoxidable AISI 304 - EN 1.4301  
 Mola Aço Inoxidável AISI 304 - EN 1.4301

# 134

**PRESA A CALZAMENTO**

COMPRESSION SOCKET  
 VERSCHLUSS-KUPPLUNG MIT ÜBERWURFVERSCHRAUBUNG  
 CORPS À RACCORD À COIFFE  
 ENCHUFE TUBO  
 SOQUETE COM CONEXÃO PUSH-ON

Code	A	C	D	CH	Pack.
00134 00 001	10/8	61	28	24	10
00134 00 002	12/10	63	28	24	10

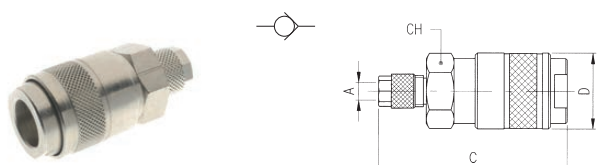

### 135

**PRESA CON PORTAGOMMA A RESCA**

BARBED SOCKET

VERSCHLUSS-KUPPLUNG MIT SCHLAUCHTÜLLE

COUPLEUR À DOUILLE ANNELÉE POUR TUBE

ENCHUFE ESPIGA

SOQUETE COM ESPIGÃO PARA MANGUEIRA DE BORRACHA

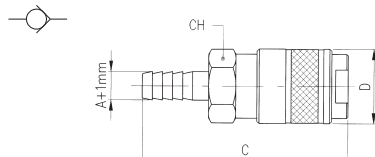

Code	A	C	D	CH	Pack.
00135 00 001	8	66	28	24	10
00135 00 002	10	66	28	24	10
00135 00 003	12	66	28	24	10

### 231

**INNESTO MASCHIO**

MALE PLUG

STECKER MIT AUSSENGEWINDE

EMBOUT MÂLE

ADAPTADOR MACHO

PLUG COM ROSCA MACHO

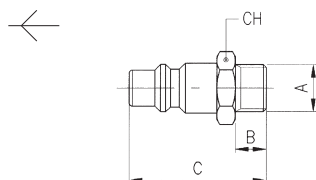

Code	A	B	C	CH	Pack.
00231 00 01 04 NB	3/8	9	40	19	10
00231 00 01 05 NB	1/2	10	41.5	24	10

### 232

**INNESTO FEMMINA**

FEMALE PLUG

STECKER MIT AUSSENGEWINDE

EMBOUT FEMELLE

ADAPTADOR HEMBRA

PLUG COM ROSCA FÊMEA

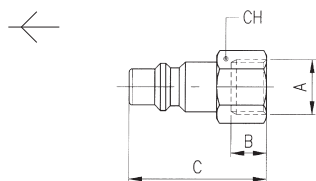

Code	A	B	C	CH	Pack.
00232 00 01 04 NB	3/8	11.5	39.5	20	10
00232 00 01 05 NB	1/2	14	42	24	10

### 233

**INNESTO A CALZAMENTO CON MOLLA**

COMPRESSION PLUG WITH SPRING

STECKER MIT KNICKSCHUTZFEDER

EMBOUT AVEC RESSORT DE PROTECTION

ADAPTADOR TUBO CON MUELLE

PLUG COM CONEXÃO PUSH-ON COM MOLA

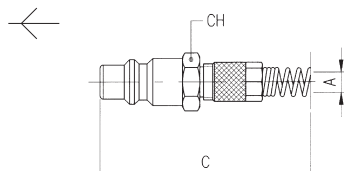

Code	A	C	CH	Pack.
00233 00 001	10/8	140	16	10
00233 00 002	12/10	147	16	10

Molla Acciaio Inox AISI 304 - EN 1.4301  
 Stainless Steel Spring AISI 304 - EN 1.4301  
 Edelstahlfeder AISI 304 - EN 1.4301  
 Ressort Acier Inoxydable AISI 304 - EN 1.4301  
 Muelle Acero Inoxidable AISI 304 - EN 1.4301  
 Mola Aço Inoxidável AISI 304 - EN 1.4301

**234**

**INNESTO A CALZAMENTO**

COMPRESSION PLUG  
 STECKER MIT ÜBERWURFVERSCHRAUBUNG  
 EMBOUT À RACCORD À COIFFE  
 ADAPTADOR TUBO  
 PLUG COM CONEXÃO PUSH-ON

Code	A	C	CH	Pack.
00234 00 001	10/8	46	16	10
00234 00 002	12/10	47.5	16	10

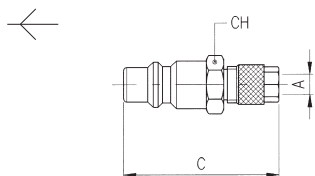

**235**

**INNESTO CON PORTAGOMMA A RESCA**

BARBED PLUG  
 STECKER MIT SCHLAUCHTÜLLE  
 EMBOUT À DOUILLE ANNELÉE POUR TUBE  
 ADAPTADOR ESPIGA  
 PLUG COM ESPIGÃO PARA TUBO DE BORRACHA

Code	A	C	Pack.
00235 00 01 X7 NB	8	46	10
00235 00 01 X9 NB	10	46	10
00235 00 01 Y1 NB	12	48.5	10

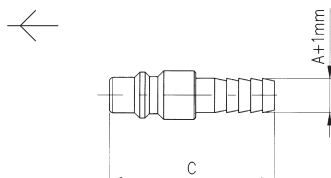

**237**

**INNESTO A BAIONETTA**

BAYONET PLUG  
 STECKER MIT BAJONETT-VERSCHLUSS  
 EMBOUT À BAIONETTE  
 ADAPTADOR BAYONETA  
 PLUG COM CONEXÃO TIPO BAIONETA

Code	A	C	CH	Pack.
00237 00 001	15	39.5	16	10

