











Prese ad Innesto Rapido - Quick Couplings - Schnellverschluss Kupplungen - Coupleurs Automatiques - Enchufes Rápidos - Conexões de Engate Rápido

<p>SERIE UNI ISO 6150 A-6</p>  <p>Serie 100 Pag. 15.7 - 15.10</p>	<p>SERIE MIGNON New</p>  <p>Serie 110 Pag. 15.11 - 15.16</p>	<p>SERIE UNI ISO 6150 B-12</p>  <p>Serie 120 Pag. 15.17 - 15.22</p>	<p>ITALIAN PROFILE</p>  <p>Serie 120 Pag. 15.23 - 15.28</p>
<p>SERIE UNI ISO 6150 B-15</p>  <p>Serie 130 Pag. 15.29 - 15.33</p>	<p>SERIE UNI ISO 6150 C-10</p>  <p>Serie 140 Pag. 15.34 - 15.39</p>	<p>EUROPEAN PROFILE</p>  <p>Serie 160 Pag. 15.40 - 15.45</p>	<p>SWISS PROFILE</p>  <p>Serie 170 Pag. 15.46 - 15.50</p>
<p>MIGNON PROFILE New</p>  <p>Serie 180 Pag. 15.51 - 15.54</p>	<p>MULTISOCKET New</p>  <p>Serie 190 - 63190 Pag. 15.55 - 15.61</p>	<p>JAPANESE PROFILE</p>  <p>Serie 400 Pag. 15.62 - 15.64</p>	<p>Serie 700 Pag. 15.65 - 15.67</p>
<p>SERIE UNI ISO 6150 B-17</p>  <p>Serie 710 Pag. 15.68 - 15.70</p>	<p>B-SOCKET EUROPEAN</p>  <p>Serie 720 Pag. 15.71 - 15.74</p>	<p>EUROPEAN PROFILE New</p>  <p>Serie 730 Pag. 15.75 - 15.80</p>	<p>EUROPEAN PROFILE New</p>  <p>Serie 740 Pag. 15.81 - 15.83</p>

Prese di Sicurezza ad Innesto Rapido - Safety Quick Couplings - Kupplungen Sicherheit - Coupleurs de Sécurité - Enchufes de Seguridad - Conexões de Segurança

<p>SERIE UNI ISO 6150 B-12</p>  <p>Serie 620 Pag. 15.85 - 15.88</p>	<p>ITALIAN PROFILE</p>  <p>Serie 650 Pag. 15.89 - 15.90</p>	<p>EUROPEAN PROFILE</p>  <p>Serie 660 Pag. 15.91 - 15.92</p>	<p>SWISS PROFILE</p>  <p>Serie 670 Pag. 15.93 - 15.94</p>
<p>SERIE UNI ISO 6150 B-12</p>  <p>Serie 0B120 Pag. 15.97 - 15.99</p>	<p>SERIE UNI ISO 6150 C-10</p>  <p>Serie 0B140 Pag. 15.100 - 15.102</p>	<p>EUROPEAN PROFILE New</p>  <p>Serie 0B160 Pag. 15.103 - 15.105</p>	

Giunti ad Innesto Rapido per Raffreddamento Stampi - Quick Couplings for Molding Cooling - Schnellkupplungen für Spritzgussanwendungen - Coupleurs pour Moules D'injection - Enchufes Rápidos para Refrigeración de Moldes - Conexões de Engate Rápido para Resfriamento de Moldes

<p>FRENCH PROFILE DN 8 - DN 12</p>  <p>Series 410 - 420 - 510 - 520 Pag. 15.104 - 15.110</p>	<p>INTERNATIONAL PROFILE DN 6 - DN 9</p>  <p>Series 430 - 440 - 530 - 540 Pag. 15.112 - 15.119</p>	<p>EUROPEAN PROFILE DN 6 - DN 9</p>  <p>Series 460 - 470 - 560 - 570 Pag. 15.120 - 15.127</p>	<p>6049 Pag. 15.128</p> 
--	--	--	--

Pistole di Soffiaggio - Blow Guns - Blasipistolen - Soufflettes - Pistolas Sopladoras - Pistola de Ar

 <p>Series 360 Pag. 15.130 - 15.132</p>	 <p>Series 300 Pag. 15.133 - 15.135</p>	 <p>Spare Parts Pag. 15.136</p>	 <p>Series 340 Pag. 15.137</p>
---	---	--	--

Aligned si riserva il diritto di variare modelli e ingombri senza preavviso - Aligned reserves the right to vary models and dimensions without notice - Aligned behält sich das Recht vor, Daten ohne Ankündigung zu ändern
 Aligned se reserva el derecho de modificar modelos y dimensiones sin previo aviso - Aligned se reserva o direito de alterar os modelos e dimensões sem prévio aviso

SERIE 190 MULTISOCKET



Un'unica presa per 4 tipi di innesti

IT

E' un dato di fatto che sul mercato esistono vari profili di innesti ben distinti sia nella forma che nelle dimensioni e generalmente necessitano di essere assemblati con specifiche prese che di norma non sono intercambiabili fra di loro.

Per poter ovviare a questa incompatibilità AIGNEP propone alla sua clientela una soluzione pratica ed economica, un'unica presa da utilizzare con 4 differenti tipi di profili garantendo per tutti una perfetta tenuta.

One socket for 4 different plugs

GB

It is a matter of fact that on the market are available various types of plugs well distinguished whether on the shape or on the dimensions, usually they need to be assembled with specific sockets which normally are not interchangeable.

To get round to this incompatibility AIGNEP is proud to offer to its customers a practical and cost-effective solution, a unique socket to be used with 4 different types of plugs, ensuring a perfect tightening.

1 Kupplung Für 4 Typen Von Steckern

DE

Es ist eine Tatsache, dass die auf dem Markt verfügbaren Kupplungen und Stecker mit verschiedenen, nicht kompatiblen Profilen in Form und Grösse geliefert werden, d.h. sie können nicht untereinander ausgetauscht montiert werden.

Um diese Austauschbarkeit zu ermöglichen, bietet AIGNEP seinen Kunden eine praktische und kostengünstige Lösung an, wo mit einer Kupplung 4 verschiedene Profile (Stecker) verwendet werden können und dennoch eine perfekte Abdichtung gewährleistet ist.

1 Corps pour 4 Embouts

FR

Le marché met à disposition des utilisateurs des différents types de coupleurs qui varient selon les normes, la forme et les dimensions. Souvent il est nécessaire d'assembler plusieurs types de coupleurs qui ne sont pas interchangeables.

Pour contourner cette incompatibilité AIGNEP est fière d'offrir à ses clients une solution pratique, fiable et rentable où un corps unique pour être utilisé avec 4 embouts différents.

Un único enchufe para 4 tipos de adaptador

ES

Es un dato a remarcar que en el mercado existen varios tipos de adaptadores distintos, ya sea en la forma como en las dimensiones, que generalmente necesitan de enchufes específicos no intercambiables entre ellos.

Para solucionar este problema AIGNEP, propone una solución práctica y económica de intercambiabilidad con todos los adaptadores homologados en el mercado europeo, garantizando para todos una perfecta estanqueidad.

Um único soquete p/ 4 tipos de plugs

PT

É um fato que no mercado existem vários perfis de plug bem diferentes entre si, seja no seu formato ou com relação às suas medidas e que, por isto normalmente não são intercambiáveis, necessitando de um soquete específico para cada diferente tipo de plug.

Para fugir desta incompatibilidade de tipos de modelos a AIGNEP propõe a seus clientes uma solução prática e econômica: um único soquete para ser utilizado com 4 diferentes tipos de perfis, garantindo para todos uma vedação perfeita.

PROFIL SWISS
SERIE 270

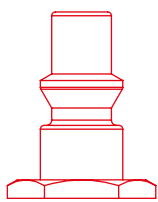

1:1

DN
5.5 mm

Pag. 15.49

PROFIL EUROPEAN
SERIE 260

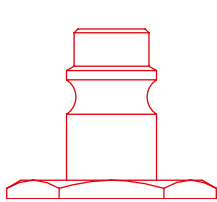

1:1

DN
7.5 - 7.8 mm

Pag. 15.44

PROFIL ITALIAN
SERIE 250

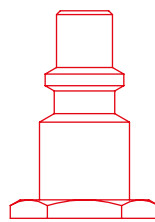

1:1

DN
5 mm

Pag. 15.27

PROFIL UNI ISO 6150 B-12
SERIE 220

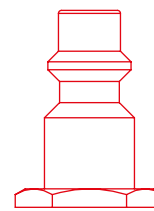

1:1

DN
5.5 mm

Pag. 15.21



CARATTERISTICHE TECNICHE
 TECHNICAL CHARACTERISTICS
 TECHNISCHE ANGABEN
 CARACTÉRISTIQUES TECHNIQUES
 CARACTERÍSTICAS TÉCNICAS
 CARACTERÍSTICAS TÉCNICAS



Norma di Riferimento
 Reference standard
 Entspricht der Norm
 Norme de référence
 Normativa de referencia
 Norma de referència

1907/2006 REACH ✓	2011/65/CE RoHS ✓
PED 2014/68/UE	SILICON FREE

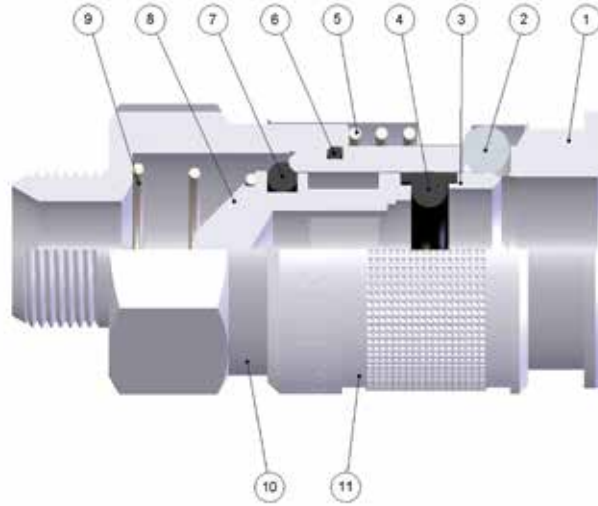

FKM A RICHIESTA
 IF REQUESTED FKM
 FKM AUF ANFRAGE
 FKM SUR DEMANDE
 FKM BAJO DEMANDA
 FKM SOB ENCOMENDA

Materiali e Componenti	IT	Component Parts and Materials	GB	Komponenten und Materialien	DE
1 Corpo in Ottone Nichelato		1 Nickel-Plated Brass Body		1 Körper Messing Vernickelt	
2 Sfera in Acciaio AISI 420		2 Stainless Steel AISI 420 Balls		2 Kugel Edelstahl AISI 420	
3 Anello Guida Innesto in Ottone Nichelato		3 Nickel-Plated Brass Guide Ring Coupling		3 Ring Aus Messing	
4 Guarnizione O-Ring in NBR		4 NBR O-Ring Seals		4 O-Ring NBR	
5 Molla Ghiera in Acciaio AISI 302		5 Stainless Steel AISI 302 Ring Nut Spring		5 Entriegelungsfeder Edelstahl AISI 302	
6 Guarnizione O-Ring in NBR		6 NBR O-Ring Seals		6 O-Ring NBR	
7 Guarnizione O-Ring in NBR		7 NBR O-Ring Seals		7 O-Ring NBR	
8 Otturatore in Ottone Nichelato		8 Nickel-Plated Brass Shutter		8 Verschluss Messing Vernickelt	
9 Molla Otturatore in Acciaio AISI 302		9 Stainless Steel AISI 302 Shutter Spring		9 Verschlussfeder Edelstahl AISI 302	
10 Attacco Terminale in Ottone Nichelato		10 Nickel-Plated Brass Coupling Back Part		10 Einschraubkörper Messing Vernickelt	
11 Ghiera in Ottone Nichelato		11 Nickel-Plated Brass Sleeve		11 Entriegelungshülse Messing Vernickelt	

Matériaux et Composants	FR	Materialies y Componentes	ES	Materialis e Componentes	PT
1 Corps: Laiton Nickelé		1 Cuerpo en latón niquelado		1 Corpo em latão niquelado	
2 Bille: Acier Inoxydable AISI 420		2 Esfera en acero AISI 420		2 Esfera em aço AISI 420	
3 Bague en Laiton		3 Anillo guía enchufe en latón niquelado		3 Anel guia do plug em latão niquelado	
4 Joint Torique en NBR		4 Junta tórica en NBR		4 Vedação O-Ring em NBR	
5 Ressort de Bague: Acier Inoxydable AISI 302		5 Muelle tuerca en acero AISI 302		5 Mola de porca em aço AISI 302	
6 Joint Torique en NBR		6 Junta tórica en NBR		6 Vedação O-Ring em NBR	
7 Joint Torique en NBR		7 Junta tórica en NBR		7 Vedação O-Ring em NBR	
8 Clapet en Laiton Nickelé		8 Obturador en latón niquelado		8 Obturador em latão niquelado	
9 Ressort de Clapet: Acier Inoxydable AISI 302		9 Muelle obturador en acero AISI 302		9 Mola do obturador em aço AISI 302	
10 Corps: Laiton Nickelé		10 Conexión terminal en latón niquelado		10 Conexão terminal em latão niquelado	
11 Bague: Laiton Nickelé		11 Tuerca en latón niquelado		11 Porca em latão niquelado	



Temperature
 Temperatures
 Temperatur
 Températures
 Temperaturas
 Temperaturas

- 20 °C
+ 80 °C

Con O-ring in FKM
 With FKM O-ring
 Mit O-ring in FKM
 Avec Joints en FKM
 Con Junta tórica en FKM
 Com O-ring em FKM

- 10 °C
+ 200 °C



Fluidi compatibili
 Aria compressa

Fluids
 Compressed air

Geeignete Medien
 Druckluft

Fluides compatibles
 Air comprimé

Fluidos compatibles
 Aire comprimido

Fluidos compatíveis
 Ar comprimido

Per altri fluidi, consultare l'ufficio tecnico Aignep.
 For other fluids, consult the technical department Aignep.
 Für andere Flüssigkeiten, kontaktieren Sie uns.
 Pour d'autres fluides, veuillez nous consulter.
 Para otros fluidos póngase en contacto con el departamento técnico Aignep.
 Para outros fluidos consulte o departamento técnico da Aignep.



Pressione d'esercizio

Working Pressures

Betriebsdruck

Pression de service

Presión de Ejercicio

Pressão de Trabalho

0 bar

16 bar



Max pressione statica (no pulsazioni)

Maximum static pressure (no pulsations)

Maximaler statischer Betriebsdruck (ohne pulsations)

Pression statique maximale (sans pulsation)

Presión estática máxima (sin pulsaciones)

Pressão estática máxima (sem pulsações)

35 bar



Portata

NI/min

Flow Rate

Durchflusswerte

Débit

Caudal de Flujo

Vazão

Innesto Plug Stecker Embout Adaptador Plug	6 bar Δ 1	6 bar Δ 0.5	6 bar *
220	900	700	1450
250	800	700	1300
260 (7.5)	1350	1000	2150
260 (7.8)	1510	1200	2250
270	1100	750	1600

* Scarico libero - Exhaust Free - Kostenlose Auspuff - Échappement libre - Escape Libre - Descarga livrer.



Filettatura

IT

Threads

GB

Gewindearten

DE

Gas cilindrica conforme ISO 228 Classe A.

Parallel gas in conformity with ISO 228 Class A.

Zylindrisches Gewinde nach Norm ISO 228 Classe A.

Filetages

FR

Roscas

ES

Roscas

PT

Filetage cylindrique conforme: ISO 228 Classe A.

Gas cilindrica conforme ISO 228 Classe A.

Gas paralela conforme ISO 228 Classe A.

191

PRESA MASCHIO

MALE SOCKET

VERSCHLUSS-KUPPLUNG MIT AUSSENGEWINDE

COUPLEUR MÂLE

ENCHUFE MACHO

SOQUETE COM ROSCA MACHO

New

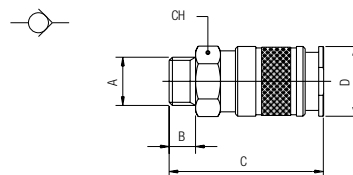

Code	A	B	C	D	CH	Pack.
00191 00 001	1/4	8	49	24	21	10
00191 00 002	3/8	9	50	24	21	10
00191 00 003	1/2	10	51	24	24	10
Code FKM						
00191 V0 001	1/4	8	49	24	21	10
00191 V0 002	3/8	9	50	24	21	10
00191 V0 003	1/2	10	51	24	24	10

192

PRESA FEMMINA

FEMALE SOCKET

VERSCHLUSS-KUPPLUNG MIT INNENGEWINDE

COUPLEUR FEMELLE

ENCHUFE HEMBRA

SOQUETE COM ROSCA FÊMEA

New

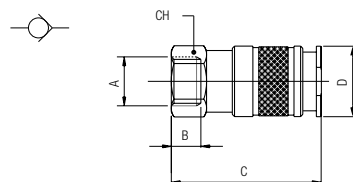

Code	A	B	C	D	CH	Pack.
00192 00 001	1/4	11	51	24	21	10
00192 00 002	3/8	11.5	51	24	21	10
00192 00 003	1/2	14	55	24	24	10
Code FKM						
00192 V0 001	1/4	11	51	24	21	10
00192 V0 002	3/8	11.5	51	24	21	10
00192 V0 003	1/2	14	55	24	24	10

193

New

PRESA A CALZAMENTO CON MOLLA

COMPRESSION SOCKET WITH SPRING
 VERSCHLUSS-KUPPLUNG MIT KNICKSCHUTZFEDER
 COUPLEUR AVEC RESSORT DE PROTECTION
 ENCHUFE TUBO CON MUELLE
 SOQUETE COM CONEXÃO PUSH-ON COM MOLA

Code	A	C	D	CH	Pack.
00193 00 001	6/4	138	24	21	10
00193 00 002	8/6	144.5	24	21	10
00193 00 004	10/6.5	153.5	24	21	10
00193 00 003	10/8	153.5	24	21	10
00193 00 006	12/8-12/9	159	24	21	10
00193 00 005	12/10	159	24	21	10

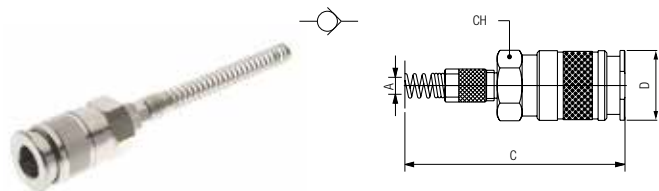

Molla Acciaio Inox AISI 304 - EN 1.4301
 Stainless Steel Spring AISI 304 - EN 1.4301
 Edelstahlfeder AISI 304 - EN 1.4301
 Ressort Acier Inoxydable AISI 304 - EN 1.4301
 Muelle Acero Inoxidable AISI 304 - EN 1.4301
 Mola Aço Inoxidável AISI 304 - EN 1.4301

194

PRESA A CALZAMENTO

COMPRESSION SOCKET
 VERSCHLUSS-KUPPLUNG MIT ÜBERWURFVERSCHRAUBUNG
 COUPLEUR RACCORD À COIFFE
 ENCHUFE TUBO
 SOQUETE COM CONEXÃO PUSH-ON

Code	A	C	D	CH	Pack.
00194 00 001	6/4	55	24	21	10
00194 00 002	8/6	55	24	21	10
00194 00 003	10/8	55	24	21	10
00194 00 007	12/10	57.5	24	21	10

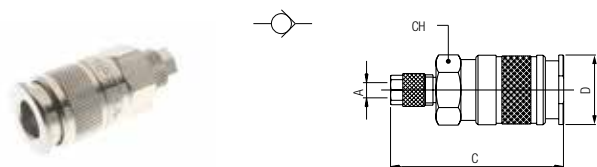

195

PRESA CON PORTAGOMMA A RESCA

BARBED SOCKET
 VERSCHLUSS-KUPPLUNG MIT SCHLAUCHTÜLLE
 COUPLEUR À DOUILLE ANNELÉE POUR TUBE
 ENCHUFE ESPIGA
 SOQUETE COM ESPIGÃO PARA MANGUEIRA DE BORRACHA

Code	A	C	D	CH	Pack.
00195 00 001	6	61	24	21	10
00195 00 002	8	61	24	21	10
00195 00 003	10	61	24	21	10
00195 00 004	12	61	24	21	10

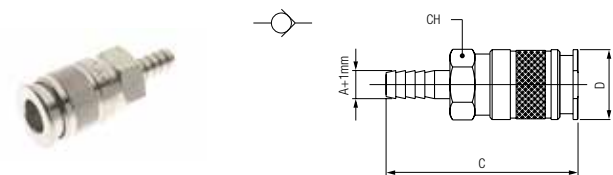

196

PRESA CON PORTAGOMMA

SOCKET FOR RUBBER HOSE
 VERSCHLUSS-KUPPLUNG FÜR GUMMISCHLAUCH
 COUPLEUR À DOUILLE ANNELÉE POUR TUBE
 ENCHUFE CON PORTAGOMA
 SOQUETE COM ESPIGÃO PARA TUBO DE BORRACHA

Code	A	C	D	CH	Pack.
00196 00 001	14/6	71	24	21	10
00196 00 002	17/8	71	24	21	10
00196 00 003	19/10	71	24	21	10

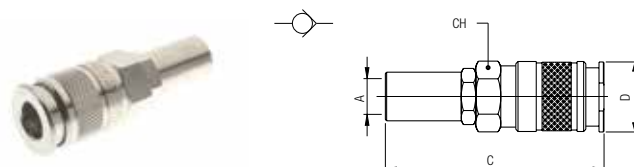

SERIE INOX AISI 316L

MULTIPRESA IN ACCIAIO INOX
 STAINLESS STEEL MULTISOCKET
 KUPPLUNGEN AUS EDELSTAHL
 COUPLEURS AUTOMATIQUES EN ACIER INOXYDABLE
 MULTIPRESA EN ACERO INOX
 CONEXÃO MULTISOCKET EM AÇO INOX



CARATTERISTICHE TECNICHE

TECHNICAL CHARACTERISTICS
 TECHNISCHE ANGABEN
 CARACTÉRISTIQUES TECHNIQUES
 CARACTERÍSTICAS TÉCNICAS
 CARACTERÍSTICAS TÉCNICAS

Norma di Riferimento

Reference standard
 Entspricht der Norm
 Norme de référence
 Normativa de referencia
 Norma de referência

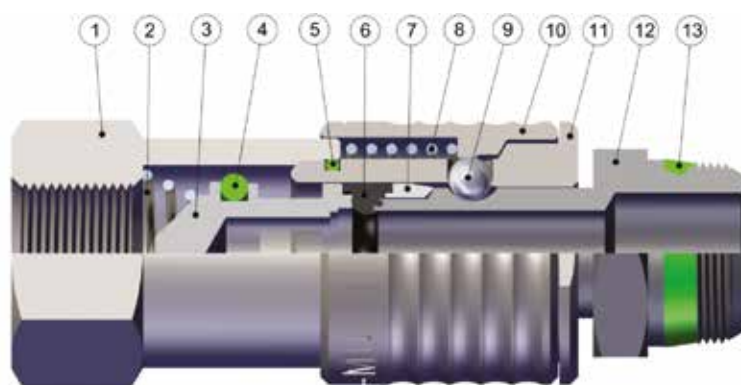
1907/2006 REACH ✓	2011/65/CE RoHS ✓
PED 2014/68/UE	SILICON FREE

Materiali e Componenti
IT

- 1 Attacco terminale in acciaio INOX AISI 316L
- 2 Molla otturatore in acciaio INOX AISI 302
- 3 Otturatore in acciaio INOX AISI 316L
- 4 Guarnizione O-Ring Otturatore in FKM alimentare
- 5 Guarnizione O-Ring corpo in FKM alimentare
- 6 Guarnizione innesto in FKM alimentare
- 7 Anello guida innesto in acciaio INOX AISI 316L
- 8 Molla ghiera in acciaio INOX AISI 302
- 9 Sfera in acciaio INOX AISI 420
- 10 Ghiera in acciaio INOX AISI 316L
- 11 Corpo in acciaio INOX AISI 316L
- 12 Innesto in acciaio INOX AISI 316L
- 13 Guarnizione filetto in FKM alimentare

Component Parts and Materials
GB

- 1 AISI 316L Steel coupling back part
- 2 AISI 302 Steel shutter thrust spring
- 3 AISI 316L Steel shutter
- 4 Food FKM shutter O-Ring seal
- 5 Food FKM body O-Ring seal
- 6 Food FKM plug seal
- 7 AISI 316L Steel guide ring coupling
- 8 AISI 302 Steel ring nut spring
- 9 AISI 420 Steel ball
- 10 AISI 316L Steel sleeve
- 11 AISI 316L Steel body
- 12 AISI 316L Steel plug outline
- 13 Food FKM thread packing

Komponenten und Materialien
DE

- 1 Einschraubkörper edelstahl AISI 316L
- 2 Verschlussfeder edelstahl AISI 302
- 3 Verschluss edelstahl AISI 316L
- 4 Verschluss O-Ring FKM Lebensmittel
- 5 Körper O-Ring FKM Lebensmittel
- 6 Stecker O-Ring FKM Lebensmittel
- 7 Stecker führungsring edelstahl AISI 316L
- 8 Entriegelungsfeder edelstahl AISI 302
- 9 Kugel edelstahl AISI 420
- 10 Entriegelungshülse edelstahl AISI 316L
- 11 Körper edelstahl AISI 316L
- 12 Stecker edelstahl AISI 316L
- 13 Gewindedichtung FKM Lebensmittel

Matériaux et Composants
FR

- 1 Corps: AISI 316L
- 2 Ressort de clapet: AISI 302
- 3 Clapet: AISI 316L
- 4 Joint torrique: FKM conforme alimentaire
- 5 Joint torrique: FKM conforme alimentaire
- 6 Joint: FKM conforme alimentaire
- 7 Bague de guidage: AISI 316L
- 8 Ressort de bague: AISI 302
- 9 Bille: AISI 420
- 10 Bague: AISI 316L
- 11 Corps: AISI 316L
- 12 Embout: AISI 316L
- 13 Etanchéité: conforme alimentaire

Materialies y Componentes
ES

- 1 Terminal de conexión en acero INOX AISI 316L
- 2 Muelle obturador en acero INOX AISI 302
- 3 Obturador en acero INOX AISI 316L
- 4 Junta tórica Obturador en FKM alimentaria
- 5 Junta tórica cuerpo en FKM alimentaria
- 6 Junta adaptador en FKM alimentaria
- 7 Anillo guía adaptador en acero INOX AISI 316L
- 8 Muelle tuerca en acero INOX AISI 302
- 9 Esfera en acero INOX AISI 420
- 10 Tuerca en acero INOX AISI 316L
- 11 Cuerpo en acero INOX AISI 316L
- 12 Adaptador en acero INOX AISI 316L
- 13 Junta rosca en FKM alimentaria

Materialies e Componentes
PT

- 1 Engate terminal em aço INOX AISI 316L
- 2 Mola do obturador em aço INOX AISI 302
- 3 Obturador em aço INOX AISI 316L
- 4 Vedação O-Ring do Obturador em FKM alimentício
- 5 Vedação O-Ring do corpo em FKM alimentício
- 6 Vedação do plug em FKM alimentício
- 7 Anel guia do plug em aço INOX AISI 316L
- 8 Mola da porca em aço INOX AISI 302
- 9 Esfera em aço INOX AISI 420
- 10 Porca em aço INOX AISI 316L
- 11 Corpo em aço INOX AISI 316L
- 12 Plug em aço INOX AISI 316L
- 13 Vedção de rosca em FKM alimentício



Pressione d'esercizio

Working Pressures

Betriebsdruck

Pression de service

Presión de Ejercicio

Pressão de Trabalho

0 bar (0 MPa)

16 bar (1.6 MPa)



Max pressione statica (no pulsazioni)

Maximum static pressure (no pulsations)

Maximaler statischer Betriebsdruck (ohne pulsations)

Pression statique maximale (sans pulsation)

Presión estática máxima (sin pulsaciones)

Pressão estática máxima (sem pulsações)

35 bar



Temperature

Temperatures

Temperatur

Températures

Temperaturas

Temperaturas

- 15 °C

+ 200 °C



Fluidi compatibili

Aria compressa

Fluidi per Industria alimentare e chimica compatibili con i componenti.

Fluids

Compressed air

Fluid for food and chemical industry compatible with all components.

Geeignete Medien

Druckluft

Medien für die Lebensmittel- und chemische Industrie, die beständig mit den Komponenten der Verschraubungen sind.

Fluides compatibles

Air comprimé

Fluides alimentaires et chimiques compatibles avec les matériaux constituant les raccords.

Fluidos compatibles

Aire comprimido

Fluidos para industria alimentaria y química compatibles con los componentes del racor.

Fluidos compatíveis

Ar comprimido

Fluidos para Indústria alimentícia e química compatíveis com os componentes da conexão.



Portata

NI/min

Flow Rate

Durchflusswerte

Débit

Caudal de Flujo

Vazão

Innesto Plug Stecker Embout Adaptador Plug	6 bar Δ 1	6 bar Δ 0.5	6 bar *
260 (7.8)	1510	1200	2250

* Scarico libero - Exhaust Free - Kostenlose Auspuff - Échappement libre - Escape Libre - Descarga livre.



Filettatura

IT

Gas cilindrica conforme ISO 228 Classe A.
Gas conica "UNIVERSAL SHORT".

Threads

GB

Parallel gas in conformity with ISO 228 Class A.
"UNIVERSAL SHORT" Tapered thread.

Gewindearten

DE

Zylindrisches Gewinde nach Norm ISO 228 Classe A.
Konisches Gewinde "UNIVERSAL SHORT".

Filetages

FR

Filetage cylindrique conforme: ISO 228 Classe A.
Filetage conique "UNIVERSAL SHORT".

Roscas

ES

Gas cilíndrica conforme ISO 228 Clase A.
Gas cónica "UNIVERSAL SHORT".

Roscas

PT

Gas paralela conforme ISO 228 Classe A.
Gas cónica "UNIVERSAL SHORT".

63190

PRESA MASCHIO "UNIVERSAL SHORT"

MALE SOCKET "UNIVERSAL SHORT"
 KUPPLUNG MIT AUSSENGEWINDE "UNIVERSAL SHORT"
 CORPS MÂLE "UNIVERSAL SHORT"
 ENCHUFE MACHO "UNIVERSAL SHORT"
 SOQUETE COM ROSCA MACHO TIPO "UNIVERSAL SHORT"

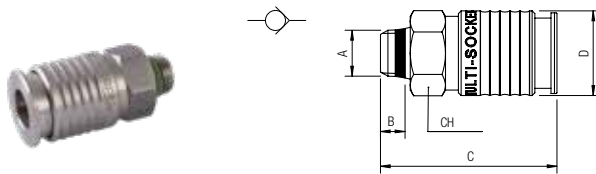

Code	A	B	C	D	CH	Pack.
63190 00 002	1/4	7	50	24	21	2
63190 00 003	3/8	7.5	50.5	24	21	2
63190 00 004	1/2	9	52	24	21	2

63192

PRESA FEMMINA

FEMALE SOCKET
 KUPPLUNG MIT INNENGEWINDE
 CORPS FEMELLE
 ENCHUFE HEMBRA
 SOQUETE COM ROSCA FÊMEA

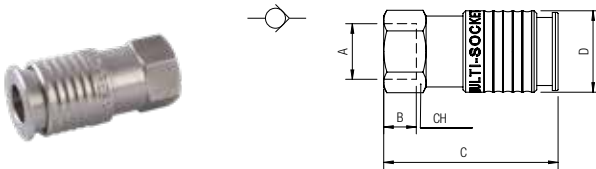

Code	A	B	C	D	CH	Pack.
63192 00 002	1/4	11	51.5	24	21	2
63192 00 003	3/8	11.5	52	24	21	2
63192 00 004	1/2	15	56.5	24	24	2

63260 DN 7.8

INNESTO PROFILO EUROPEO MASCHIO "UNIVERSAL SHORT"

MALE PLUG EUROPEAN PROFILE "UNIVERSAL SHORT"
 STECKER MIT AUSSENGEWINDE "UNIVERSAL SHORT" - EUROPEAN
 EMBOUT MÂLE "UNIVERSAL SHORT" - PROFIL EUROPEEN
 ADAPTADOR PERFIL EUROPEO MACHO "UNIVERSAL SHORT"
 PLUG COM PERFIL EUROPEU E ROSCA MACHO TIPO "UNIVERSAL SHORT"

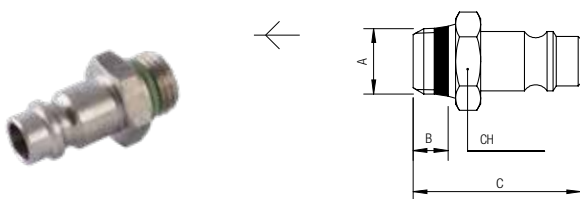

Code	A	B	C	CH	Pack.
63260 00 002	1/4	7	33.5	17	2
63260 00 003	3/8	7.5	34	19	2
63260 00 004	1/2	9	36	24	2

63262 DN 7.8

INNESTO PROFILO EUROPEO FEMMINA

FEMALE PLUG EUROPEAN PROFILE
 STECKER MIT INNENGEWINDE - EUROPEAN
 EMBOUT FEMELLE - PROFIL EUROPEEN
 ADAPTADOR PERFIL EUROPEO HEMBRA
 PLUG COM PERFIL EUROPEU E ROSCA FÊMEA

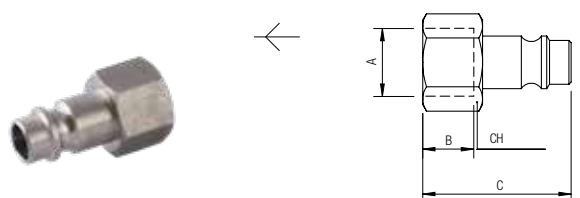

Code	A	B	C	CH	Pack.
63262 00 44 03 00	1/4	11	33	17	2
63262 00 44 04 00	3/8	11.5	33.5	19	2
63262 00 44 05 00	1/2	15	37	24	2