

RACCORDI AUTOMATICI IN TECNOPOLIMERO ALIMENTARE

FOOD-GRADE TECHNOPOLYMER PUSH-IN FITTINGS

STECKVERBINDER FÜR DEN LEBENSMITTELBEREICH AUS TECHNOPOLYMER

RACCORDS INSTANTANES EN TECHNOPOLYMERE ALIMENTAIRE

RACORES AUTOMÁTICOS EN TECNOPOLÍMERO ALIMENTARIO

CONEXÕES PUSH-IN EM TECNOPOLÍMERO ALIMENTAR

SPRINGFIT 



COMPONENT



serie Springfit



CERTIFICAZIONE MOCA - MOCA CERTIFICATION - MOCA-ZERTIFIKAT - CERTIFICATION MOCA - CERTIFICACIÓN MOCA - CERTIFICAÇÃO MOCA

Tutti i prodotti della Serie SPRINGFIT sono conformi alla direttiva MOCA Reg. 1935/2004/CE - materiali e oggetti a contatto con gli alimenti

All the SPRINGFIT products comply with the MOCA Directive Reg. 1935/2004/EC - materials in contact with foodstuffs

Alle SPRINGFIT-Produkte entsprechen der MOCA-Richtlinie 1935/2004/EG - für Materialien die in Kontakt mit Lebensmitteln stehen

Tous les produits SPRINGFIT sont conformes à la directive MOCA Reg. 1935/2004/CE - matériaux en contact avec les denrées alimentaires

Todos los productos de la Serie SPRINGFIT son conformes con la directiva MOCA Reg. 1935/2004/CE - materiales en contacto con alimentos

Todos os produtos da série SPRINGFIT estão em conformidade com a diretiva MOCA Reg. 1935/2004/CE - materiais e objetos em contato com alimentos

**DM
174**

CONFORMITÀ - COMPLIANCE - RICHTLINIE - CONFORMITÉ - CONFORMIDAD - CONFORMIDADE

DM174

Tutti i materiali della Serie SPRINGFIT sono stati testati seconda la norma DM174

All SPRINGFIT Series materials have been tested according to DM174

Alle Materialien der SPRINGFIT-Serie wurden gemäß DM174 getestet

Tous les matériaux de la série SPRINGFIT ont été testés conformément à la norme DM174

Todos los materiales de la serie SPRINGFIT han sido probados de acuerdo con la norma DM174

Todos os materiais da série SPRINGFIT foram testados de acordo com a norma DM174



CONFORMITÀ REACH - REACH COMPLIANCE - REACH KONFORMITÄT - CONFORMITÉ REACH - CONFORMIDAD REACH - CONFORMIDADE REACH

Tutti i prodotti della Serie SPRINGFIT sono conformi al regolamento REACH: CE N°1907 / 2006 riguardo l'autorizzazione e restrizione delle sostanze chimiche.

All the SPRINGFIT products comply with the REACH regulation: EC N°1907 / 2006 concerning the authorisation and restriction of chemicals

Alle SPRINGFIT-Produkte erfüllen die Anforderungen der REACH-Verordnung: EC N°1907 / 2006 über die Zulassung und Beschränkung von Chemikalien

Tous les produits SPRINGFIT sont conformes au règlement REACH : CE N°1907 / 2006 concernant l'autorisation et la restriction des produits chimiques

Todos los productos de la Serie SPRINGFIT son conformes con la regulación REACH: CE N°1907 / 2006 referente a la autorización y restricción de sustancias químicas

Todos os produtos SPRINGFIT atendem ao regulamento REACH: EC N°1907 / 2006 relativo à autorização e restrição de químicos



CONFORMITÀ ROHS - ROHS COMPLIANCE - ROHS KONFORMITÄT - CONFORMITÉ ROHS - CONFORMIDAD ROHS - CONFORMIDADE ROHS

Tutti i prodotti della Serie SPRINGFIT sono conformi alle direttive ROHS: 2011/65/UE riguardante la restrizione di sostanze pericolose nelle apparecchiature

All the SPRINGFIT products comply with the ROHS directives: 2011/65/EU on the restriction of hazardous substances in (EEE) Electrical and electronic equipment

Alle SPRINGFIT-Produkte entsprechen den ROHS-Richtlinien: 2011/65/EU zur Beschränkung der Verwendung bestimmter gefährlicher Stoffe in Elektro- und Elektronikgeräten (EEE)

Tous les produits SPRINGFIT sont conformes aux directives ROHS : 2011/65/UE sur la restriction des substances dangereuses dans les Équipements électriques et électroniques (EEE)

Todos los productos de la serie SPRINGFIT son conformes con la directiva ROHS: 2011/65/UE referente a la restricción de sustancias peligrosas en equipos

Todos os produtos SPRINGFIT atendem às diretivas ROHS: 2011/65/EU na restrição de substâncias perigosas em (EEE) Equipamentos Elétricos e Eletrônicos



CONFORMITÀ - COMPLIANCE - RICHTLINIE - CONFORMITÉ - CONFORMIDAD - CONFORMIDADE

2014/68/UE

Tutti i prodotti della Serie SPRINGFIT soddisfano i requisiti della Direttiva Europea 2014/68/UE (PED: Pressure Equipment Directive)

All the SPRINGFIT products meet the requirements as per the European Directive 2014/68/EU (PED: Pressure Equipment Directive)

Alle SPRINGFIT-Produkte erfüllen die Anforderungen gemäß der europäischen Richtlinie 2014/68/EU (PED: Pressure Equipment Directive)

Tous les produits SPRINGFIT répondent aux exigences de la Directive Européenne 2014/68/UE (PED : Directive Équipements Sous Pression)

Todos los productos de la Serie SPRINGFIT satisfacen los requisitos de la Directiva Europea 2014/68/UE (PED: Directiva de Equipos a Presión)

Todos os produtos SPRINGFIT atendem aos requisitos da European Directive 2014/68/EU (PED: Diretriz para Equipamentos de Pressão)



I prodotti della Serie SPRINGFIT sono certificati secondo lo standard NSF 169

SPRINGFIT Series products are certified according to NSF Standard 169
Die Produkte der SPRINGFIT-Serie sind nach NSF Standard 169 zertifiziert
Les produits de la série SPRINGFIT sont certifiés conformes à la norme NSF 169
Los productos de la serie SPRINGFIT están certificados según la norma NSF 169
Os produtos da série SPRINGFIT são certificados de acordo com a Norma NSF 169



Il materiale plastico soddisfa i requisiti previsti dallo standard

Plastic material meets the requirements of the standard
Kunststoffmaterial den Anforderungen der Norm entspricht
La matière plastique répond aux exigences de la norme
El material plástico cumple con los requisitos de la norma
O material plástico atende aos requisitos da norma



Il materiale plastico soddisfa i requisiti previsti dallo standard

Plastic material meets the requirements of the standard
Kunststoffmaterial den Anforderungen der Norm entspricht
La matière plastique répond aux exigences de la norme
El material plástico cumple con los requisitos de la norma
O material plástico atende aos requisitos da norma



Il materiale plastico soddisfa i requisiti previsti dallo standard

Plastic material meets the requirements of the standard
Kunststoffmaterial den Anforderungen der Norm entspricht
La matière plastique répond aux exigences de la norme
El material plástico cumple con los requisitos de la norma
O material plástico atende aos requisitos da norma



Il materiale plastico soddisfa i requisiti previsti dallo standard

Plastic material meets the requirements of the standard
Kunststoffmaterial den Anforderungen der Norm entspricht
La matière plastique répond aux exigences de la norme
El material plástico cumple con los requisitos de la norma
O material plástico atende aos requisitos da norma



Il materiale plastico soddisfa i requisiti previsti dallo standard CFR 177.1500

Plastic material meets the requirements of the standard CFR 177.1500
Kunststoffmaterial den Anforderungen der Norm entspricht CFR 177.1500
La matière plastique répond aux exigences de la norme CFR 177.1500
El material plástico cumple con los requisitos de la norma CFR 177.1500
O material plástico atende aos requisitos da norma CFR 177.1500

Aignep con la Serie SPRINGFIT, nel rispetto della continua evoluzione normativa del settore alimentare, propone una gamma di prodotti conformi alla 1935/2004/CE. I corpi dei raccordi sono realizzati in tecnopolimero alimentare che combinano la compatibilità alimentare alla resistenza ad alte temperature fino a +80°C. Le guarnizioni sono in EPDM alimentare.

Principali vantaggi

- Conformi 1935/2004/CE
- Connessione e sconnessione istantanea
- Pieno passaggio e tenuta al vuoto
- Peso ridotto
- No pumping-effect
- Vasta gamma
- Silicon Free

Applicazioni

- Industria agroalimentare
- Macchine per caffè e vending
- Food & Beverage
- Trattamento acqua
- Medica
- Vuoto

Avec la série SPRINGFIT Aignep, en ligne avec les évolutions continues de la réglementation du secteur alimentaire, propose une gamme de produits conformes aux normes 1935/2004/CE. Les corps des raccords sont constitués d'un technopolymère qui allie la compatibilité alimentaire avec une résistance à des températures allant jusqu'à +80°C. Les joints sont en EPDM de qualité alimentaire.

Principaux avantages

- Conformés 1935/2004/CE
- Connexion et déconnexion rapides
- Plein débit et excellente tenue au vide primaire
- Faible poids
- No pumping-effect
- Large gamme
- Sans silicone

Applications

- Industries agroalimentaire
- Machines à café
- Distributeurs de boisson
- Traitement de l'eau
- Médical
- Vide

With the SPRINGFIT Series Aignep, in line with the continuous food sector regulation developments, offers a range of products in compliance with 1935/2004/EC. The fittings' bodies are made of a technopolymer that combines the food compatibility with the resistance to temperatures as high as +80°C. Gaskets are made of food-grade EPDM.

Main advantages

- Compliance with 1935/2004/CE
- Quick connection and disconnection
- Full Flow and Vacuum resistant
- Light weight
- No pumping-effect
- Large range
- Silicon Free

Applications

- Dairy
- Coffee Machines, Vending
- Food & Beverage
- Water treatment
- Medical
- Vacuum

Mit der SPRINGFIT-Serie wird Aignep den kontinuierlichen Entwicklungen im Lebensmittelsektor gerecht, eine Produktserie Anzubieten die den Anforderungen nach 1935/2004/EG entspricht. Die Gehäuse der Fittings sind aus einem Technopolymer, das die Lebensmittelverträglichkeit mit einer Temperaturbeständigkeit von bis zu +80°C verbindet. Die Dichtungen sind aus lebensmittelechtem EPDM hergestellt.

Hauptvorteile

- Entsprechen 1935/2004/CE
- Schnelles Verbinden und Trennen
- Voller Durchfluss und Vakuum geeignet
- Geringes Gewicht
- No pumping-effect
- Viele Varianten
- Silikonfrei

Anwendungen

- Milchprodukte
- Kaffeemaschinen und Automaten
- Lebensmittel & Getränke
- Wasseraufbereitung
- Pharmaindustrie
- Vakuum

Aignep con la Serie SPRINGFIT, respetando la continua evolución en la regulación del sector de la alimentación, ofrece una gama de productos que cumplen con la normativa 1935/2004/CE. Los cuerpos de los racores están fabricados en tecnopolimero alimentario, que combinan la compatibilidad con alimentos con la resistencia a altas temperaturas de hasta +80°C. Las juntas son de EPDM alimentario.

Principales ventajas

- Cumplen 1935/2004/CE
- Conexión y desconexión instantánea
- Paso completo y sellado al vacío.
- Peso reducido
- No pumping-effect
- Amplia gama
- Libre de silicona

Aplicaciones

- Industria agroalimentaria
- Máquinas de café y vending
- Alimentos y bebidas
- Tratamiento del agua
- Medical
- Vacío

Com a série de SPRINGFIT, fortemente alinhada com os desenvolvimentos contínuos dos regulamentos do setor alimentar, a Aignep oferece uma nova gama de produtos em conformidade com a normativa 1935/2004/EC. O corpo das conexões é fabricado em tecnopolimero que combina a compatibilidade alimentar com a resistência a temperaturas de até +80°C. As vedações são fabricadas em EPDM alimentar.

Principais vantagens

- Conformidade 1935/2004/CE
- Conexão e desconexão instantânea
- Passagem plena e vedação para vácuo
- Peso reduzido
- No pumping-effect
- Vasta gama de variações
- Silicon Free

Aplicações

- Indústria Agro-alimentar
- Máquinas de café, vending machines
- Alimentícia e bebidas
- Tratamento de água
- Médica
- Vácuo



CARATTERISTICHE TECNICHE
 TECHNICAL CHARACTERISTICS
 TECHNISCHE ANGABEN
 CARACTÉRISTIQUES TECHNIQUES
 CARACTERÍSTICAS TÉCNICAS
 CARACTERÍSTICAS TÉCNICAS



Norma di Riferimento
 Reference standard
 Entspricht der Norm
 Norme de référence
 Normativa de referencia
 Norma de referência



Certificazioni del materiale plastico
 Certification of the plastic material
 Zertifizierungen für den Kunststoff
 Certifications des matières plastiques
 Certificaciones del material plástico
 Certificação do material de plástico

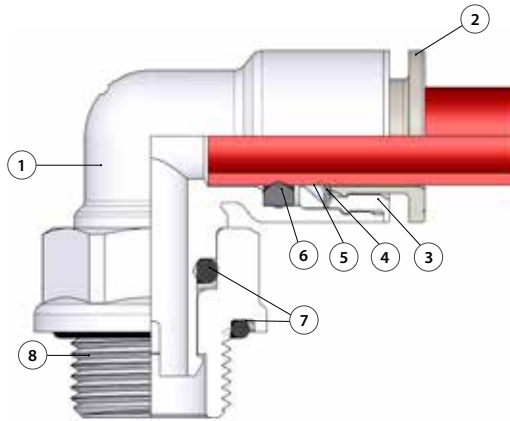
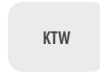

Materiali e Componenti	IT	Component Parts and Materials	GB	Komponenten und Materialien	DE
1 Corpo in tecnopolimero alimentare		1 Food-grade technopolymer body		1 Körper aus Technopolymer für den Lebensmittelbereich	
2 Spintore sgancio tubo in tecnopolimero alimentare		2 Food-grade technopolymer collet		2 Spannzange aus Technopolymer für den Lebensmittelbereich	
3 Capsula in tecnopolimero alimentare		3 Food-grade technopolymer capsule		3 Kapsel aus Technopolymer für den Lebensmittelbereich	
4 Pinza d'aggraffaggio in acciaio inox AISI 301		4 AISI 301 Steel gripping ring		4 Greifring aus AISI 301 Stahl	
5 Anello di posizionamento in tecnopolimero alimentare		5 Food-grade technopolymer positioning ring		5 Positionierring aus Technopolymer für den Lebensmittelbereich	
6 Guarnizione sagomata in EPDM alimentare		6 Food-grade EPDM moulded seal		6 Formdichtung aus EPDM für den Lebensmittelbereich	
7 Guarnizione O-ring EPDM alimentare		7 Food-grade EPDM O-ring		7 O-Ring aus EPDM für den Lebensmittelbereich	
8 Basetta filettata in tecnopolimero alimentare		8 Food-grade technopolymer threaded adaptor		8 Gewindeadapter aus Technopolymer für den Lebensmittelbereich	

Matériaux et Composants	FR	Materiales y componentes	ES	Materiais e Componentes	PT
1 Corps en technopolymère alimentaire		1 Cuerpo en tecnopolímero alimentario		1 Corpo em tecnopolímero alimentar	
2 Bouton poussoir en technopolymère alimentaire		2 Anillo de extracción en tecnopolímero alimentario		2 Anilha de liberação do tubo em tecnopolímero alimentar	
3 Capsule en technopolymère alimentaire		3 Cápsula en tecnopolímero alimentario		3 Cápsula em tecnopolímero alimentar	
4 Rondelle accrochage en Inox AISI 301		4 Pinza de agarre acero inox AISI 301		4 Pinça de travamento em aço inox AISI 301	
5 Bague de positionnement en technopolymère alimentaire		5 Anillo de posicionamiento en tecnopolímero alimentario		5 Anel de posicionamento em tecnopolímero alimentar	
6 Joint de forme en EPDM de qualité alimentaire		6 Junta de forma EPDM alimentario		6 Vedação moldada em EPDM alimentar	
7 Joint torique en EPDM alimentaire		7 Junta EPDM alimentario		7 Vedação O-ring em EPDM alimentar	
8 Embase fileté en technopolymère alimentaire		8 Base roscada tecnopolímero alimentario		8 Base roscada em tecnopolímero alimentar	



Fluidi compatibili

Vuoto / Acqua / Acqua calda (max 80°C) / Alimenti / Azoto / Gas compatibili con la natura dei materiale

Fluids

Vacuum / Water / Hot water (max 80 °C) / Food / Nitrogen / Gases compatible with the nature of the materials

Geeignete Medien

Vakuum / Wasser / Warmwasser (max. 80°C) / Lebensmittel / Stickstoff / Gase, die mit der Beschaffenheit des Materials kompatibel sind

Fluides compatibles

Vide / Eau / Eau chaude (max 80° C) / Boissons / Azote / Gaz compatibles avec la nature du matériau

Fluidos compatibles

Vacio / Agua / Agua caliente (máximo 80°C) / Alimentos / Nitrógeno / Gases compatibles con la naturaleza del material

Fluidos compatíveis

Vácuo / Água / Água quente (máx 80 °C) / Alimentos / Nitrogênio / Gases compatíveis com a natureza do material



Pressione - Temperatura	IT	Pressures - Temperatures	GB	Druckbereich - Temperatur	DE
Pressioni e temperature dei diversi diametri della linea di raccordi SPRINGFIT®		Pressures and temperatures of the different diameters of the SPRINGFIT line®		Drücke und Temperaturen der verschiedenen Durchmesser der SPRINGFIT®-Verbindungsline Serie	
Temperatura		Temperatures		Temperatur	
-10 °C / +80 °C		-10 °C / +80 °C		-10 °C / +80 °C	
Pressions - Températures	FR	Presiones - Temperaturas	ES	Pressões - Temperaturas	PT
Pressions et températures de différents diamètres de la ligne de raccords SPRINGFIT®		Presiones y temperaturas de los diferentes diámetros de la línea de accesorios SPRINGFIT®		Pressões e temperaturas dos diferentes diâmetros da linha SPRINGFIT®	
Températures		Temperaturas		Temperaturas	
-10 °C / +80 °C		-10 °C / +80 °C		-10 °C / +80 °C	

Ø	Pressures	-10 °C	20 °C	40 °C	65 °C	80 °C
4 mm	16 bar	100 %	100 %	80 %	50 %	50 %
6 mm	16 bar	100 %	100 %	80 %	50 %	50 %
8 mm	16 bar	100 %	100 %	80 %	50 %	50 %
10 mm	13 bar	100 %	100 %	70 %	40 %	33 %
12 mm	11 bar	100 %	100 %	63 %	40 %	36 %



Tubi di Collegamento	IT	Connection Tubes	GB	Geeignete Rohre	DE
Tubi in materiale plastico: PA6, PA11, PA12, Polietilene, *Poliuretano, PTFE, FEP. *Utilizzo da 90 a 98 Shore, per la massima prestazione è consigliato 98 Shore A.		Plastic tubes: PA6, PA11, PA12, Polyethylene, *Polyurethane, PTFE, FEP. *Use from 90 to 98 Shore, for maximum performance is recommended 98 Shore A.		Kunststoffrohre: PA6, PA11, PA12, Polyethylene, *Polyurethan, PTFE, FEP. *Verwenden Sie 90 bis 98 Shore, für maximale Leistung wird 98 Shore A empfohlen.	
Tubes Conseillés	FR	Tubos de Conexión	ES	Tubos de Conexão	PT
Tubes plastiques: PA6, PA11, PA12, Polyéthylène, *Polyuréthane, PTFE, FEP. *Utilisation de 90 à 98 Shore, pour une performance maximale recommandée 98 Shore A.		Tubos en material plástico: PA6, PA11, PA12, Polietileno, *Poliuretano, PTFE, FEP. *Uso de 90 a 98 Shore, para un máximo rendimiento se recomienda 98 Shore A.		Tubos em material plástico: PA6, PA11, PA12, Polietileno, *Poliuretano, PTFE, FEP. *Uso de 90 a 98 Shore, para o desempenho máximo é recomendado 98 Shore A.	



Filettatura	IT	Threads	GB	Gewindearten	DE
Gas cilindrica conforme ISO 228.		BSPP gas in conformity with ISO 228.		Zylindrisches Gewinde nach Norm ISO 228.	
Filetages	FR	Roscas	ES	Roscas	PT
Filetage cylindrique conforme: ISO 228.		Gas cilíndrica conforme ISO 228.		Gas paralela conforme ISO 228.	



Coppia di serraggio

Torque specifications

Angaben Drehmoment

Couple de serrage

Par de apriete

Especificações de Torque

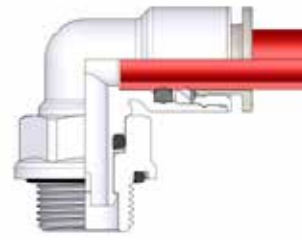

ISO 228

I valori di rottura possono variare in base all'articolo
 Breaking values may vary according to the item
 Die maximal werte dienen nur zu informationszwecken
 Les valeurs maximales sont présentées à titre indicatif
 Los valores de rotura pueden variar en función del artículo
 Os valores de ruptura podem variar em função do item

MISURA SIZE GRÖSSE DIMENSIONS MEDIDA MEDIDA	COPPIA CONSIGLIATA Nm RECOMMENDED TORQUE Nm EMPFOHLENES DREHMOMENT Nm COUPLE DE SERRAGE Nm PAR ACONSEJADO Nm TORQUE RECOMENDADO Nm
1/8	2 ÷ 2,5
1/4	3,5 ÷ 4,5
3/8	4,5 ÷ 5,5
1/2	5,5 ÷ 6,5

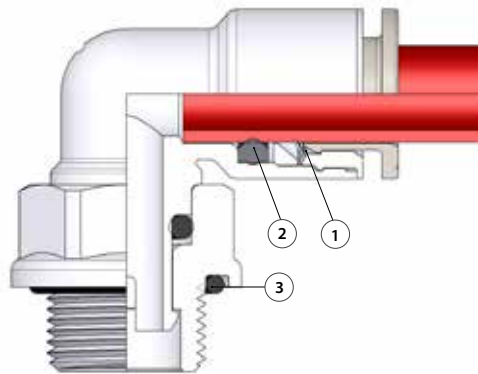

Vantaggi

- 1 La pinza in acciaio inox garantisce il perfetto aggraffaggio di tubi di qualsiasi materiale senza danneggiarne la superficie. Il collegamento tra tubo e raccordo assicura una tenuta totale anche in condizioni di urti e vibrazioni.
- 2 La guarnizione sagomata permette inoltre l'utilizzo dei raccordi anche con il vuoto.
- 3 Tutte le filettature di questa Serie sono state dotate di elementi di tenuta che permettono l'immediato utilizzo dei raccordi riducendo notevolmente i tempi di installazione.

IT

Advantages

- 1 The stainless steel gripping ring guarantees a perfect joint with tubes of any material without damaging the surface. The connection between the tube and the fitting ensures a perfect sealing even under severe conditions such as shock and vibration.
- 2 The shaped gasket shape makes the fittings suitable for vacuum too.
- 3 All the SPRINGFIT threads comes with a sealing ring for an immediate use, to drastically reduce the installation time.

GB

Vorteile

- 1 Konisches Gewinde "kurz" Die Zahnscheibe sorgt für eine perfekte Halterung des Rohres ohne die Oberfläche zu beschädigen. Die Dichtheit zwischen Rohr und Verschraubung ist auch bei Erschütterungen und Vibrationen gewährleistet.
- 2 Die Formdichtung Dichtung ermöglicht auch die Anwendung der Verschraubungen in Verbindung mit Vakuum.
- 3 Alle Verschraubungen in dieser Serie sind mit Gewindeabdichtungen ausgestattet, die den sofortigen Einsatz ermöglichen und daher die Montagezeit stark reduzieren.

DE

Avantages

- 1 La rondelle en acier inoxydable garantit la parfaite tenue du tube quelle que soit la matière et sans l'endommager. La connexion entre le tube et le raccord assure une étanchéité totale même dans des conditions d'impact ou de vibrations.
- 2 Le joint façonné du joint permet l'utilisation des raccords avec le vide.
- 3 Tous les filetages de cette série sont équipés d'éléments d'étanchéité qui permettent l'utilisation immédiate des raccords réduisant ainsi le temps d'installation.

FR

Ventajas

- 1 La pinza en acero inoxidable garantiza el perfecto agarre del tubo de cualquier material sin perjudicar la superficie. La conexión entre tubo y racor asegura una estanqueidad total aun en condiciones de impacto o vibración.
- 2 La junta perfilada garantiza una perfecta estanqueidad incluso en vacío.
- 3 Todas las rosas de esta Serie están fabricadas con junta de cierre que permite la inmediata utilización del racor reduciendo notablemente el tiempo de instalación.

ES

Vantagens

- 1 A pinça em aço-inox garante o perfeito travamento do tubo de qualquer material sem danificar a superfície do mesmo. A conexão entre o tubo e a conexão assegura uma vedação total também em condições de impactos e vibrações.
- 2 A gaxeta moldada permite a utilização da conexão também para aplicações com vácuo.
- 3 Todas as rosas desta série são dotadas de elementos de vedação, o que permite a imediata utilização das conexões, reduzindo notavelmente o tempo de instalação.

PT

54020

RACCORDO DIRITTO MASCHIO CILINDRICO

STRAIGHT MALE ADAPTOR (PARALLEL)
 GERADE EINSCHRAUBVERSCHRAUBUNG ZYLINDRISCH
 RACCORD DROIT MÂLE, CYLINDRIQUE
 RACOR RECTO MACHO CILÍNDRICO CON TÓRICA
 CONEXÃO RETA COM ROSCA PARALELA

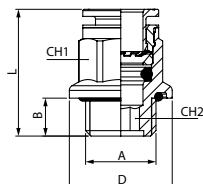

Code	Tube	A	B	L	CH1	CH2	D	Pack.
54020 00 002	4	1/8	6	18.7	10	3	16	10
54020 00 022	4	1/4	7	20.2	10	3	19	10
54020 00 003	6	1/8	6	20.7	12	4	16	10
54020 00 004	6	1/4	7	20.7	12	4	19	10
54020 00 005	8	1/8	6	26.4	14	5	16	10
54020 00 006	8	1/4	7	23.4	14	6	19	10
54020 00 007	8	3/8	8	24.4	14	6	22	10
54020 00 008	10	1/4	7	30	18	7	19	10
54020 00 009	10	3/8	8	28	18	8	22	10
54020 00 031	10	1/2	10	29	18	8	27	10
54020 00 011	12	3/8	8	32.4	20	8	22	10
54020 00 023	12	1/2	10	32.4	22	10	27	10

54040

RACCORDO DIRITTO INTERMEDIO

STRAIGHT CONNECTOR
 VERBINDUNGSVERSCHRAUBUNG
 RACCORD UNION DOUBLE
 RACOR RECTO INTERMEDIO
 CONEXÃO RETA TUBO-TUBO

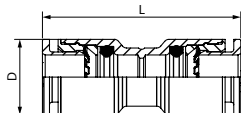

Code	Tube	Tube	D	L	Pack.
54040 00 002	4	4	8.7	25.4	10
54040 00 009	6	4	10.7	30.6	10
54040 00 004	6	6	10.7	30.9	10
54040 00 015	8	4	14	36	10
54040 00 010	8	6	14	36.3	10
54040 00 005	8	8	14	36.8	10
54040 00 014	10	6	17.3	42.9	10
54040 00 011	10	8	17.3	43.4	10
54040 00 006	10	10	17.3	44	10
54040 00 016	12	8	20	48.8	10
54040 00 012	12	10	20	49.4	10
54040 00 007	12	12	20	49.8	10

54050

RACCORDO DIRITTO INTERMEDIO DI ATTRAVERSAMENTO

BULKHEAD CONNECTOR
 SCHOTTVERSCHRAUBUNG
 TRAVERSÉE DE CLOISON
 RACOR RECTO INTERMEDIO PASATABIQUES
 CONEXÃO PASSA-MURO RETA TUBO-TUBO

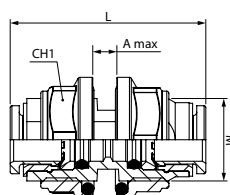

Ø4 - Ø6

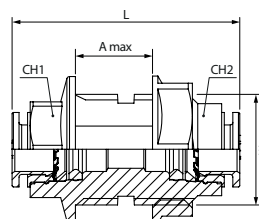

Ø8 - Ø10 - Ø12

Code	Tube	M	L	CH1	CH2	A max	Pack.
54050 00 001	4	M10x1	25	13	-	5.5	10
54050 00 002	6	M12x1	28	15	-	8.5	10
54050 00 003	8	G 1/2	42.8	18	25	14.5	10
54050 00 004	10	G 1/2	44	18	25	14.5	10
54050 00 005	12	G 3/4	53.8	22	32	18.5	10

54116

RACCORDO A L ORIENTABILE MASCHIO CILINDRICO RIDOTTO

REDUCED SWIVELING ELBOW MALE ADAPTOR (PARALLEL)
 WINKELVERSCHRAUBUNG ZYLINDRISCH (DREHBAR) REDUZIERT
 EQUERRE ORIENTABLE MÂLE, CYLINDRIQUE REDUITE
 RACOR A L ORIENTABLE MACHO CILÍNDRICO CON TÓRICA REDUCIDO
 CONEXÃO MACHO EM "L" ORIENTÁVEL COM ROSCA PARALELA REDUZIDO

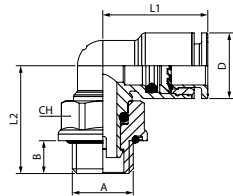

Code	Tube	A	B	L1	L2	CH	D	Pack.
54116 00 004	4	1/8	6	14.9	18.8	12	8.7	10
54116 00 005	4	1/4	7	14.9	20.3	12	8.7	10
54116 00 013	6	1/8	6	16.4	19.8	14	10.7	10
54116 00 014	6	1/4	7	16.4	20.8	14	10.7	10
54116 00 017	8	1/8	6	22.4	21.5	14	14	10
54116 00 018	8	1/4	7	22.4	23	16	14	10
54116 00 019	8	3/8	8	22.4	25	16	14	10
54116 00 021	10	1/4	7	27	25	16	17.3	10
54116 00 022	10	3/8	8	27	27	18	17.3	10
54116 00 023	10	1/2	10	27	30.5	18	17.3	10
54116 00 025	12	3/8	8	30.9	28	18	20	10
54116 00 026	12	1/2	10	30.9	31.5	20	20	10

54117

RACCORDO A L ORIENTABILE MASCHIO CILINDRICO

SWIVELING ELBOW MALE ADAPTOR (PARALLEL)
 WINKELVERSCHRAUBUNG ZYLINDRISCH (DREHBAR)
 EQUERRE ORIENTABLE MÂLE, CYLINDRIQUE
 RACOR A L ORIENTABLE MACHO CILÍNDRICO CON TÓRICA
 CONEXÃO MACHO EM "L" ORIENTÁVEL COM ROSCA PARALELA

New

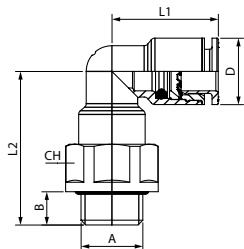

Code	Tube	A	B	L1	L2	CH	D	Pack.
54117 00 004	4	1/8	6	14.9	23.5	12	8.7	10
54117 00 005	4	1/4	7	14.9	24.5	12	8.7	10
54117 00 013	6	1/8	6	17.7	26.5	14	10.7	10
54117 00 014	6	1/4	7	17.7	27.5	14	10.7	10
54117 00 015	6	3/8	8	21.9	33.4	18	14	10
54117 00 017	8	1/8	6	22.4	32.4	18	14	10
54117 00 018	8	1/4	7	22.4	32.4	18	14	10
54117 00 019	8	3/8	8	22.4	33.4	18	14	10
54117 00 020	8	1/2	10	26.4	39.7	22	17.3	10
54117 00 021	10	1/4	7	27	38.7	22	17.3	10
54117 00 022	10	3/8	8	27	38.7	22	17.3	10
54117 00 023	10	1/2	10	27	39.7	22	17.3	10
54117 00 025	12	3/8	8	30.9	43.7	25	20	10
54117 00 026	12	1/2	10	30.9	44.7	25	20	10

54130

RACCORDO A L INTERMEDIO

ELBOW CONNECTOR
 WINKELVERSCHRAUBUNG
 RACCORD EQUERRE
 RACOR A L INTERMEDIO
 CONEXÃO EM "L" TUBO-TUBO

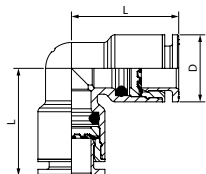

Code	Tube	Tube	D	L	Pack.
54130 00 002	4	4	8.7	14.9	10
54130 00 014	6	4	10.7	17.7	10
54130 00 004	6	6	10.7	17.7	10
54130 00 009	8	6	14	22.4	10
54130 00 005	8	8	14	22.4	10
54130 00 010	10	8	17.3	27	10
54130 00 006	10	10	17.3	27	10
54130 00 011	12	10	20	30.9	10
54130 00 007	12	12	20	30.9	10

54140

RACCORDO A L CON CODA LISCIA CORTA

ORIENTING ELBOW

WINKELSTECKVERSCHRAUBUNG KURZ

RACCORD EQUERRE ENCLIQUETABLE

RACOR A L ORIENTABLE CON ESPIGA LISA CORTA

CONEXÃO EM "L" COM PONTA LISA E CURTA

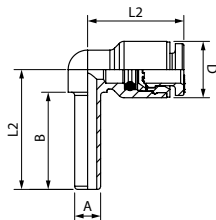

Code	Tube	A	B	L1	L2	D	Pack.
54140 00 001	4	4	15	14.9	18.5	8.7	10
54140 00 002	4	6	17.5	17.5	22.5	10.7	10
54140 00 005	6	6	17.5	17.7	22.5	10.7	10
54140 00 012	6	8	20.5	21.9	26.5	14	10
54140 00 007	8	8	20.5	22.4	26.5	14	10
54140 00 008	8	10	24	26.4	31.5	17.3	10
54140 00 009	10	10	24	27	31.5	17.3	10
54140 00 010	10	12	27	30.5	35.5	20	10
54140 00 011	12	12	27	30.9	35.5	20	10

54216

RACCORDO A T ORIENTABILE MASCHIO CILINDRICO RIDOTTO

REDUCED SWIVELING TEE MALE ADAPTOR (PARALLEL)-CENTRE LEG

T-EINSCHRAUBVERSCHRAUBUNG ZYLINDRISCH (DREHBAR) REDUZIERT

TÉ ORIENTABLE À PIQUAGE MÂLE CENTRAL, CYLINDRIQUE REDUITE

RACOR A T ORIENTABLE MACHO CILÍNDRICO CON TÓRICA REDUCIDO

CONEXÃO EM "T" ORIENTÁVEL COM ROSCA MACHO PARALELA REDUZIDO

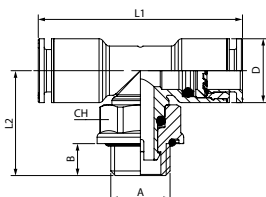

Code	Tube	A	B	L1	L2	CH	D	Pack.
54216 00 004	4	1/8	6	29.8	18.8	12	8.7	10
54216 00 005	4	1/4	7	29.8	20.3	12	8.7	10
54216 00 013	6	1/8	6	32.8	19.8	14	10.7	10
54216 00 014	6	1/4	7	32.8	20.8	14	10.7	10
54216 00 017	8	1/8	6	44.8	21.5	14	14	10
54216 00 018	8	1/4	7	44.8	23	16	14	10
54216 00 019	8	3/8	8	44.8	25	16	14	10
54216 00 021	10	1/4	7	54	25	16	17.3	10
54216 00 022	10	3/8	8	54	27	18	17.3	10
54216 00 023	10	1/2	10	54	30.5	18	17.3	10
54216 00 025	12	3/8	8	61.8	28	18	20	10
54216 00 026	12	1/2	10	61.8	31.5	20	20	10

54217

New

RACCORDO A T ORIENTABILE MASCHIO CILINDRICO

SWIVELING TEE MALE ADAPTOR (PARALLEL)-CENTRE LEG

T-EINSCHRAUBVERSCHRAUBUNG ZYLINDRISCH (DREHBAR)

TÉ ORIENTABLE À PIQUAGE MÂLE CENTRAL, CYLINDRIQUE

RACOR A T ORIENTABLE MACHO CILÍNDRICO CON TÓRICA

CONEXÃO EM "T" ORIENTÁVEL COM ROSCA MACHO PARALELA

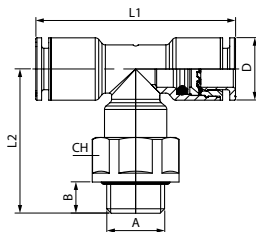

Code	Tube	A	B	L1	L2	CH	D	Pack.
54217 00 004	4	1/8	6	29.8	23.5	12	8.7	10
54217 00 005	4	1/4	7	29.8	24.5	12	8.7	10
54217 00 013	6	1/8	6	35.4	26.5	14	10.7	10
54217 00 014	6	1/4	7	35.4	27.5	14	10.7	10
54217 00 017	8	1/8	6	44.8	32.4	18	14	10
54217 00 018	8	1/4	7	44.8	32.4	18	14	10
54217 00 019	8	3/8	8	44.8	33.4	18	14	10
54217 00 021	10	1/4	7	54	38.7	22	17.3	10
54217 00 022	10	3/8	8	54	38.7	22	17.3	10
54217 00 023	10	1/2	10	54	39.7	22	17.3	10
54217 00 025	12	3/8	8	61.8	43.7	25	20	10
54217 00 026	12	1/2	10	61.8	44.7	25	20	10

54227

New



RACCORDO A T ORIENTABILE MASCHIO LATERALE CILINDRICO

ORIENTING TEE MALE ADAPTOR (PARALLEL) - OFF - SET LEG
 L-EINSCHRAUBVERSCHRAUBUNG ZYLINDRISCH (DREHBAR)
 TÉ ORIENTABLE À PIQUAGE LATÉRAL, CYLINDRIQUE
 RACOR A T ORIENTABLE MACHO LATERAL CILÍNDRICO CON TÓRICA
 CONEXÃO MACHO EM "T" LATERAL ORIENTÁVEL COM ROSCA PARALELA

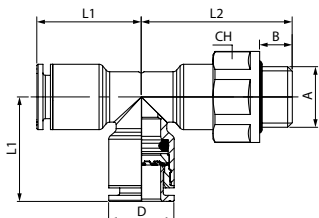

Code	Tube	A	B	L1	L2	CH	D	Pack.
54227 00 004	4	1/8	6	14.9	23.5	12	8.7	10
54227 00 005	4	1/4	7	14.9	24.5	12	8.7	10
54227 00 013	6	1/8	6	17.7	26.5	14	10.7	10
54227 00 014	6	1/4	7	17.7	27.5	14	10.7	10
54227 00 017	8	1/8	6	22.4	32.4	18	14	10
54227 00 018	8	1/4	7	22.4	32.4	18	14	10
54227 00 019	8	3/8	8	22.4	33.4	18	14	10
54227 00 021	10	1/4	7	27	38.7	22	17.3	10
54227 00 022	10	3/8	8	27	38.7	22	17.3	10
54227 00 023	10	1/2	10	27	39.7	22	17.3	10
54227 00 025	12	3/8	8	30.9	43.7	25	20	10
54227 00 026	12	1/2	10	30.9	44.7	25	20	10

54230

RACCORDO A T INTERMEDIO

TEE CONNECTOR
 T-ANSCHLUSS
 RACCORD TÉ
 RACOR A T INTERMEDIO
 CONEXÃO EM "T" TUBO-TUBO

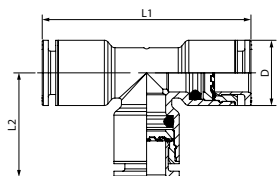

Code	Tube	L1	L2	D	Pack.
54230 00 002	4	29.8	14.9	8.7	10
54230 00 004	6	35.4	17.7	10.7	10
54230 00 005	8	44.8	22.4	14	10
54230 00 006	10	54	27	17.3	10
54230 00 007	12	61.8	30.9	20	10

54600

ADATTATORE MASCHIO CILINDRICO

MALE ADAPTOR PARALLEL
 EINSCHRAUBSTECKVERSCHRAUBUNG ZYLINDRISCH
 ADAPTATEUR ENLIQUETABLE MÂLE, CYLINDRIQUE
 ADAPTADOR MACHO CILÍNDRICO CON TÓRICA
 ADAPTADOR MACHO COM ROSCA PARALELA

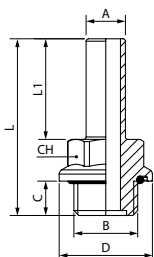

Code	A	B	C	D	L	L1	CH	Pack.
54600 00 002	4	1/8	6	16	29	15	12	10
54600 00 003	6	1/8	6	16	31	17.5	13	10
54600 00 004	6	1/4	7	19	33	17.5	14	10
54600 00 019	6	3/8	8	22	35	17.5	14	10
54600 00 005	8	1/8	6	16	34	20.5	13	10
54600 00 006	8	1/4	7	19	36	20.5	14	10
54600 00 007	8	3/8	8	22	38	20.5	16	10
54600 00 008	10	1/4	7	19	40	24	16	10
54600 00 009	10	3/8	8	22	42	24	16	10
54600 00 017	10	1/2	10	27	46	24	18	10
54600 00 011	12	3/8	8	22	45	27	18	10
54600 00 020	12	1/2	10	27	33.5	22	20	10

54625

GIUNZIONE DOPPIA

DOUBLE JOINT
 DOPPELSTECKER
 JONCTION DOUBLE (TECHNOPOLYMÈRE)
 UNIÓN DOBLE
 JUNÇÃO DUPLA



Code	Tube	L	L1	Pack.
54625 00 B4 X1 00	4	34.5	16	10
54625 00 B4 X4 00	6	39.5	18.5	10
54625 00 B4 X7 00	8	42	19.5	10
54625 00 B4 X9 00	10	51.5	24	10
54625 00 B4 Y1 00	12	60	28	10

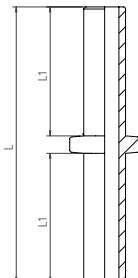

54610

TAPPO

PLUG
 VERSCHLUSSZAPFEN
 BOUCHON
 TAPÓN
 TAMPÃO



Code	ØD1	G	L	L1	Pack.
54610 00 B4 X1 00	4	6	29.5	15.5	10
54610 00 B4 X4 00	6	8	32	15.5	10
54610 00 B4 X7 00	8	10	35.5	19.5	10
54610 00 B4 X9 00	10	12	40	19.5	10
54610 00 B4 Y1 00	12	14	41.5	20	10

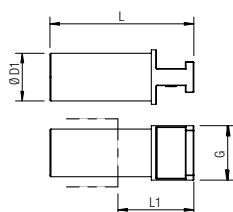

54700

RIDUZIONE

REDUCER
 REDUZIERUNG
 RÉDUCTION ENCLIQUETABLE
 REDUCCION
 REDUÇÃO

New



Code	A	B	L	D	Pack.
54700 00 001	6	4	28.7	8.7	10
54700 00 008	8	4	35.2	11.2	10
54700 00 002	8	6	35.4	11.2	10
54700 00 011	10	6	39.4	14	10
54700 00 003	10	8	39.9	14	10
54700 00 007	12	8	45.9	17.3	10
54700 00 010	12	10	46.5	17.3	10

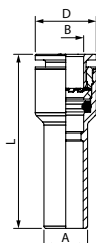

TUBI CONSIGLIATI TBPE (VEDI CAPITOLO TUBI)

RECOMMENDED TBPE TUBES (SEE CHAPTER PIPES)
 EMPFOHLENE TBPE-ROHRE (SIEHE KAPITEL ROHRE)
 TUBES TBPE RECOMMANDÉS (VOIR CHAPITRE TUBES)
 TUBOS TBPE RECOMENDADOS (VÉASE EL CAPÍTULO TUBOS)
 TUBOS TBPE RECOMENDADOS (CONSULTE OS TUBOS DO CAPÍTULO)



55800EN

CARTUCCE A COMPRESIONE (EPDM)

(EPDM) PUSH-FIT CARTRIDGES
 EINPRESSPATRONEN (EPDM)
 CARTOUCHE (EPDM)
 CARTUCHO A COMPRESIÓN (EPDM)
 CARTUCHO DE COMPRESSÃO (EPDM)

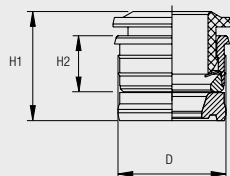

Code	Tube	D	H1	H2	Pack.
55800 E0 N01	4	8.7	10.9	5.6	25
55800 E0 N03	6	10.75	12.9	6.9	25
55800 E0 N04	8	12.7	13	6.85	25
55800 E0 N05	10	15.7	15.5	8.5	25
55800 E0 N06	12	18.3	17.7	9.5	25

SEDE

SEAT
 BOHRUNGEN
 IMPLANTATION
 SEDE
 SEDE

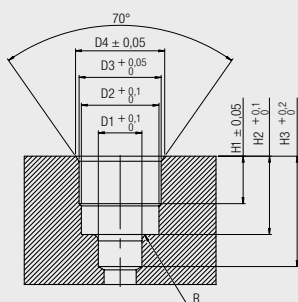

Dimensioni sedi cartucce a compressione.

Seats dimensions push-fit cartridges.
 Bohrungsangaben für die einpresspatronen.
 Dimensions des logements des cartouches.
 Dimensiones sede cartucho a compresión.
 Dimensão da sede do cartucho de compressão.

Tube	D1	D2	D3	D4	H1	H2	H3	R
4	4.2	7.45	8.4	9	3.75	6.5	9.5	0.5
6	6.2	9.35	10.45	11.35	5	8.5	11.5	0.5
8	8.2	11.4	12.4	12.9	5.2	8.5	12.5	0.75
10	10.2	14.5	15.4	16	6.7	10.5	15	0.75
12	12.2	17	18	19	7.5	12.1	17	1

ISTRUZIONI DI MONTAGGIO CARTUCCE A COMPRESIONE ART. 55800EN

PUSH-FIT CARTRIDGES ASSEMBLING INSTRUCTIONS ART. 55800EN
 ANLEITUNG FÜR DIE MONTAGE DER EINPRESSPATRONEN ART. 55800EN
 INSTRUCTION DE MONTAGE POUR CARTOUCHE RÉF. 55800EN
 INSTRUCCIONES DE MONTAJE CARTUCHO A COMPRESIÓN ART. 55800EN
 INSTRUÇÕES DE MONTAGEM DO CARTUCHO DE COMPRESSÃO CÓD. 55800EN

1

Realizzare la sede per la cartuccia utilizzando l'apposita fresa Art. 55801.

Make the seat for the cartridge utilizing the suitable tool Art. 55801.

Machen sie die Sitze für die Einpresspatronen mit dem entsprechenden Stufenbohrer Art. 55801.

Usiner le logement de la cartouche à l'aide de l'outil de perçage réf. 55801.

Realizar la sede para el cartucho utilizando la correspondiente fresa Art. 55801.

Realize a furação da sede para o cartucho utilizando a fresa de cód. 55801.



2

Inserire la guarnizione sagomata nell'apposita sede.

Insert the seal inside of the seat.

Legen sie die dichtung in die Bohrung ein.

Insérer le joint dans le logement.

Insertar la junta en la correspondiente sede.

Insira vedação no fundo da sede.



3

Inserire la cartuccia nel canotto di montaggio Art. 55802.

Insert the cartridge into the assembling tool Art. 55802.

Legen sie die Einpress- patrone in das Montage- werkzeug Art. 55802.

Insérer la cartouche dans l'outil de montage réf. 55802.

Insertar el cartucho en el útil de montaje Art. 55802.

Insira o cartucho no tubete de montagem Cód. 55802.



4

Premere la cartuccia all'interno della sede fino ad arrivare in battuta sul piano con il canotto.

Press the cartridge inside of the seat until it will be reached the abutment surface with the assembling tool.

Drücken sie die Einpress- patrone in die Bohrung, bis das Montagewerkzeug am Werkstück ansteht.

Presser la cartouche dans le logement jusqu'à ce que l'outil de montage soit en contact avec la surface.

Empujar el cartucho al interior de la sede hasta llegar al plano con el útil de montaje.

Pressione o cartucho no interior da sede até tocar a superfície de montagem com o tubete.



55801

FRESA SEDE CARTUCCE A COMPRESSIONE

TOOL FOR PUSH-FIT CARTRIDGES SEAT

STUFENBOHRER FÜR EINPRESSPATRONEN

OUTIL DE PERCAGE POUR CARTOUCHE

FRESA SEDE CARTUCHO A COMPRESIÓN

FRESA PARA FURAÇÃO DA SEDE DO CARTUCHO DE COMPRESSÃO



Code	Tube	ø Body	Pack.
55801 00 001	4	10	1
55801 00 002	6	12	1
55801 00 003	8	12	1
55801 00 004	10	16	1
55801 00 005	12	16	1

55802

CANOTTO MONTAGGIO CARTUCCE A COMPRESSIONE

ASSEMBLING TOOL FOR PUSH-FIT CARTRIDGES

MONTAGWERKZEUG FÜR EINPRESSPATRONEN

OUTIL DE MONTAGE POUR CARTOUCHE

ÚTIL DE MONTAJE CARTUCHO A COMPRESIÓN

TUBETE PARA MONTAGEM DO CARTUCHO DE COMPRESSÃO

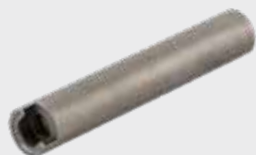

Code	Tube	Pack.
55802 00 002	4	1
55802 00 004	6	1
55802 00 005	8	1
55802 00 006	10	1
55802 00 007	12	1

ACCESSORI SPRINGFIT

SPRINGFIT ACCESSORIES
ZUBEHÖR SPRINGFIT
ACCESSOIRES SPRINGFIT
ACCESORIOS SPRINGFIT
ACESSÓRIOS SPRINGFIT

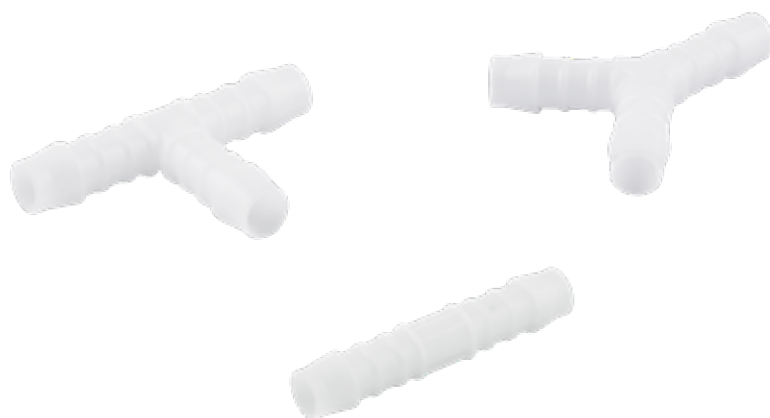

Fluidi compatibili
Vuoto / Acqua / Alimenti

Fluids
Vacuum / Water / Food

Geeignete Medien
Vakuum / Wasser / Lebensmittel

Fluides compatibles
Vide / Eau / Boissons

Fluidos compatibles
Vacío / Agua / Alimentos

Fluidos compatíveis
Vácuo / Água / Alimentos



Certificazioni del materiale plastico

Certification of the plastic material
Zertifizierungen für den Kunststoff
Certifications des matières plastiques
Certificaciones del material plástico
Certificação do material de plástico



Pressioni

Pressures
Druckbereich
Pressions
Presiones
Pressões

10 bar (1.0 MPa)



Temperature

Temperatures
Temperatur
Températures
Temperaturas
Temperaturas

- 40 °C
+ 80 °C
+ 100 °C (Max 1 hour)



Materiali

Materials
Materialen
Matériaux
Materiales
Materiais

POM FOOD GRADE

14040

RACCORDO PORTAGOMMA DIRITTO INTERMEDIO

STRAIGHT HOSE ADAPTOR
GERADER SCHLAUCHVERBINDER
DOUILLE ANNELÉE DE JONCTION
ESPIGA DOBLE INTERMEDIA
CONEXÃO TIPO ESPIGÃO RETA

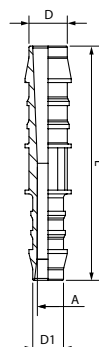

Code	D	D1	A	L	Pack.
14040 00 95 X1 00	4	4	2.7	35	20
14040 00 95 FM 00	6	4	2.7	42.5	20
14040 00 95 X4 00	6	6	4	49	20
14040 00 95 GF 00	8	6	4	54	20
14040 00 95 X7 00	8	8	5.6	56	20
14040 00 95 PR 00	10	6	4	58	20
14040 00 95 FQ 00	10	8	5.6	60.5	20
14040 00 95 X9 00	10	10	7	63	20
14040 00 95 GT 00	12	8	5.6	62.5	20
14040 00 95 FS 00	12	10	7	64	20
14040 00 95 Y1 00	12	12	8.6	66.5	20

14130

RACCORDO PORTAGOMMA A L INTERMEDIO

ELBOW HOSE ADAPTOR
WINKEL SCHLAUCHVERBINDER
EQUERRE ANNELÉE DE JONCTION
ESPIGA L INTERMEDIA
CONEXÃO TIPO ESPIGÃO EM L

Code	D	A	L1	L2	Pack.
14130 00 95 X1 00	4	2.5	17.5	19.5	20
14130 00 95 X4 00	6	4	25	26	20
14130 00 95 X7 00	8	5.6	29	30	20
14130 00 95 X9 00	10	7	31	33.5	20
14130 00 95 Y1 00	12	8.6	34.5	36	20

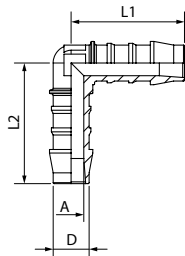

14230

RACCORDO PORTAGOMMA A T INTERMEDIO

TEE HOSE ADAPTOR
T-STÜCK SCHLAUCHVERBINDER
TE ANNELÉ DE JONCTION
ESPIGA T INTERMEDIA
CONEXÃO TIPO ESPIGÃO EM T

Code	D	D1	D2	A	B	L1	L2	Pack.
14230 00 95 X1 00	4	4	4	2.7	2.7	35	19.5	20
14230 00 95 GR 00	4	6	4	2.7	4	37	24	20
14230 00 95 X4 00	6	6	6	4	4	50	26	20
14230 00 95 KC 00	8	4	8	5.6	2.5	56	22	20
14230 00 95 GF 00	8	6	8	5.6	4	56	28	20
14230 00 95 X7 00	8	8	8	5.6	5.6	58	30	20
14230 00 95 PR 00	10	6	10	7	4	62	28	20
14230 00 95 FQ 00	10	8	10	7	5.6	62	31	20
14230 00 95 X9 00	10	10	10	7	7	62.5	33.5	20
14230 00 95 F5 00	12	10	12	8.6	7	69	33	20
14230 00 95 Y1 00	12	12	12	8.6	8.6	69	36	20

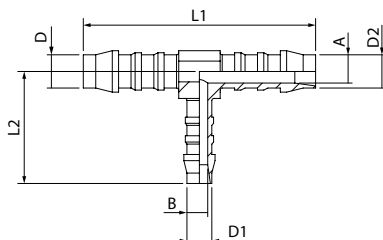

14310

RACCORDO PORTAGOMMA A Y INTERMEDIO

Y HOSE ADAPTOR
Y-STÜCK SCHLAUCHVERBINDER
Y ANNELÉ DE JONCTION
ESPIGA Y INTERMEDIA
CONEXÃO TIPO ESPIGÃO EM Y

Code	D	D1	D2	A	B	L	Pack.
14310 00 95 X1 00	4	4	4	2.5	2.5	25.5	20
14310 00 95 GR 00	4	6	4	2.7	4	35	20
14310 00 95 X4 00	6	6	6	4	4	44	20
14310 00 95 GS 00	6	8	6	4	5.6	49	20
14310 00 95 X7 00	8	8	8	5.6	5.6	51	20
14310 00 95 X9 00	10	10	10	7	7	54	20
14310 00 95 Y1 00	12	12	12	8.6	8.6	64	20

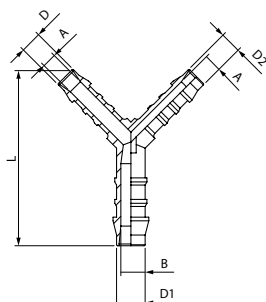

A080 MINI

REGOLATORE PER ACQUA ALIMENTARE

FOOD-GRADE WATER REGULATOR
 LEBENSMITTELECHTER WASSERREGLER
 RÉGULATEUR POUR EAU ALIMENTAIRE
 REGULADOR DE AGUA PARA USO ALIMENTARIO
 REGULADOR DE ÁGUA DE GRAU ALIMENTÍCIO



CARATTERISTICHE TECNICHE

TECHNICAL CHARACTERISTICS
 TECHNISCHE ANGABEN
 CARACTÉRISTIQUES TECHNIQUES
 CARACTERÍSTICAS TÉCNICAS
 CARACTERÍSTICAS TÉCNICAS



Norma di Riferimento

Reference standard
 Entspricht der Norm
 Norme de référence
 Normativa de referencia
 Norma de referència

1907/2006
REACH ✓

2011/65/CE
RoHS ✓

PED
 2014/68/UE

	FLUIDO FLUID MEDIEN FLUIDE FLUIDO FLUIDO	Acqua Water Wasser Eau Água Água
	ATTACCO FILETTATO THREADED ANSCHLUSS CONNEXION ROSCA CONEXÃO ROSCADA	1/8" 1/4"
	CAMPO DI REGOLAZIONE REGULATION RANGE REGELBEREICH PLAGE DE RÉGLAGE CAMPO DE REGULACIÓN FAIXA DE REGULAGEM	0 ÷ 2 bar 0 ÷ 4 bar 0 ÷ 8 bar STANDARD 0 ÷ 12 bar
	PRESSIONE MAX MAX PRESSURE DRUCK MAX PRESSION MAX PRESIÓN MAX PRESSÃO MAX	15 bar

	TEMPERATURA TEMPERATURE BETRIEBSTEMPERATUR TEMPÉRATURE DE TRAVAIL TEMPERATURA TEMPERATURA	5 °C + 50 °C
	POSIZIONE DI MONTAGGIO ASSEMBLY POSITION EINBAULAGE POSITION DE MONTAGE POSICIÓN DE MONTAJE POSIÇÃO DE MONTAGEM	Verticale Vertical Senkrecht Vertical Vertical Vertical
	ATTACCO MANOMETRO MANOMETER FASTENING MANOMETERANSCHLUSS CONNEXION MANOMÈTRE CONEXIÓN MANÓMETRO ROSCA DO MANÓMETRO	G 1/8



Tabella dei codici di ordinazione

Ordering codes
 Bestellschlüssel
 Code de commande
 Tabla de codificación para pedidos
 Tabela de codificação para compra

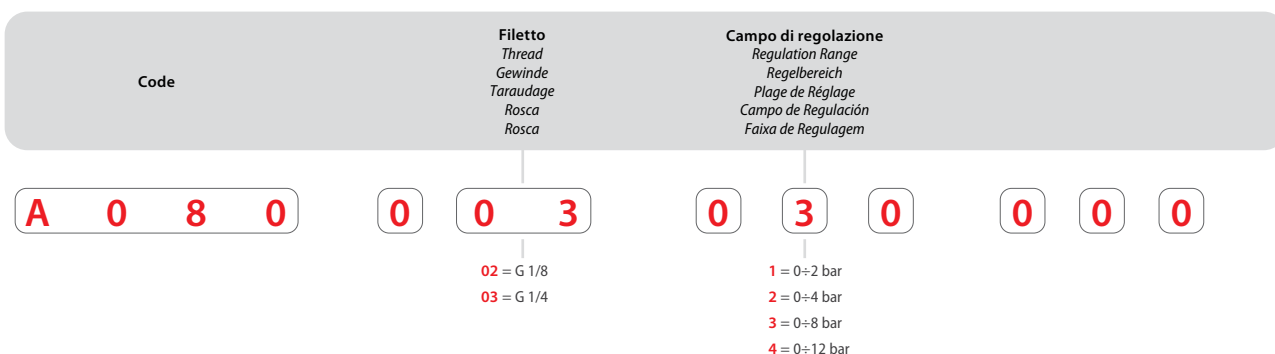

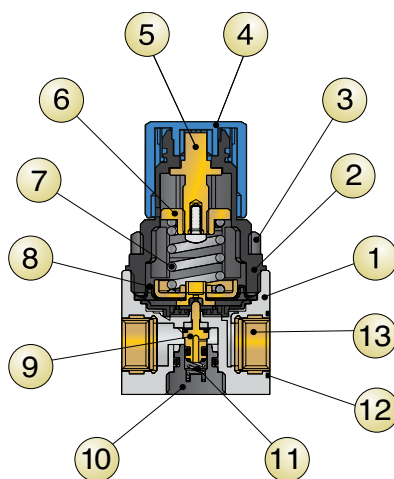

Materiali e Componenti	IT	Component Parts and Materials	GB	Komponenten und Materialien	DE
1 Corpo in tecnopolimero		1 Technopolymeric Body		1 Technopolymer Gehäuse	
2 Campana in tecnopolimero		2 Technopolymeric Bell		2 Technopolymer Glocke	
3 Ghiera di fissaggio in tecnopolimero		3 Technopolymeric Fixing nut		3 Technopolymer Befestigungsmutter	
4 Manopola in tecnopolimero		4 Technopolymeric Knob		4 Technopolymer Reglerknopf	
5 Vite di registro in ottone		5 Brass Register screw		5 Messing Einstellschraube	
6 Chiocciola in ottone		6 Brass Female screw		6 Messingmutter	
7 Molla di registro in acciaio		7 Steel Register spring		7 Regulierfeder	
8 Membrana a rotolamento - Alimentare		8 Rolling membrane - Food & grade		8 Rollmembran - Lebensmittel	
9 Otturatore con guarnizione vulcanizzata in NBR - Alimentare		9 Shutter with NBR vulcanized seal - Food & grade		9 Verschluss mit vulkanisierter NBR-Dichtung - Lebensmittel	
10 Tappo in tecnopolimero - Alimentare		10 Technopolymeric Plug - Food & grade		10 Technopolymer Stopfen - Lebensmittel	
11 Molla premiotturatore in acciaio inox		11 Stainless steel Push-shutter spring		11 Feder Edelstahl	
12 O-Ring in FKM		12 FKM O-Ring - Food & grade		12 O-Ring FKM - Lebensmittel	
13 Inserto filettato in ottone - CW510L		13 Brass Threaded insert - CW510L		13 Messing Gewindebuchse - CW510L	

Matériaux et Composants	FR	Materiales y componentes	ES	Materiais e Componentes	PT
1 Corps en technopolymère		1 Cuerpo en tecnopolímero		1 Corpo em tecnopolímero	
2 Cloche en technopolymère		2 Campana en tecnopolímero		2 Suporte interno em tecnopolímero	
3 Écrou de fixation technopolymère		3 Tuerca de fijación en tecnopolímero		3 Porca de fixação em tecnopolímero	
4 Bouton de réglage technopolymère		4 Pomo en tecnopolímero		4 Manopola em tecnopolímero	
5 Vis de réglage en laiton		5 Tornillo de registro en latón		5 Parafuso de regulagem em latão	
6 Écrou en laiton		6 Tuerca hembra en latón		6 Guia da mola em latão	
7 Ressort de régulation		7 Muelle de registro en acero		7 Mola de regulagem em aço	
8 Membrane roulante - Alimentation		8 Membrana rodante - Alimentación		8 Membrana de laminação - Alimentos	
9 Obturateur avec joint NBR vulcanisé - Alimentation		9 Obturador con junta vulcanizada en NBR - Alimentación		9 Obturador com vedação vulcanizada em NBR - Alimentos	
10 Bouchon en technopolymère - Alimentation		10 Tapón en tecnopolímero - Alimentación		10 Tampão em tecnopolímero - Alimentos	
11 Ressort acier inox		11 Muelle obturador en acero inox		11 Mola de compensação em aço inox	
12 Joint torique en FKM - Alimentation		12 Junta tórica en FKM - Alimentación		12 O-Ring em FKM - Alimentos	
13 Insert taraudé en laiton - CW510L		13 Inserción roscada en latón - CW510L		13 Inserto roscado em latão - CW510L	

A080 Mini

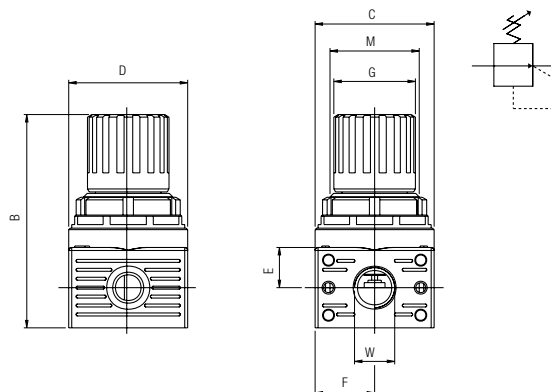

Dimensioni - Dimensions - Abmessungen - Dimensões - Dimensões.

B	C	D	E	F	G	I	M	W
74	40	40	13.5	20	27.5	27	M30X1.5	1/8 - 1/4

Standard code in stock	Misura Size Grösse Dimensions Medida Tamanho	Filetto Thread Gewinde Taraudage Rosca Rosca	Regolazione Regulation Regulation Réglage Regulación Regulagem
A080 002 030 000	WATER REG. 0	1/8	0 ÷ 8 bar
A080 003 030 000	WATER REG. 0	1/4	0 ÷ 8 bar