

## Serie 1000

 <b>1000</b> Pag. 10.6	 <b>1010</b> Pag. 10.6	 <b>1015</b> Pag. 10.6	<b>New</b>  <b>1020</b> Pag. 10.7	 <b>1021</b> Pag. 10.7	 <b>1025</b> Pag. 10.7	 <b>1026</b> Pag. 10.8	 <b>1027</b> Pag. 10.8	 <b>1028</b> Pag. 10.8
 <b>1029</b> Pag. 10.9	 <b>1030</b> Pag. 10.9	 <b>1035</b> Pag. 10.9	 <b>1040</b> Pag. 10.10	 <b>1050</b> Pag. 10.10	 <b>1100</b> Pag. 10.10	 <b>1101</b> Pag. 10.11	 <b>1110</b> Pag. 10.11	<b>New</b>  <b>1115</b> Pag. 10.11
 <b>1120</b> Pag. 10.12	 <b>1130</b> Pag. 10.12	 <b>1200</b> Pag. 10.12	 <b>1210</b> Pag. 10.13	 <b>1215</b> Pag. 10.13	 <b>1220</b> Pag. 10.13	 <b>1230</b> Pag. 10.14	 <b>1300</b> Pag. 10.14	 <b>51410</b> Pag. 10.14
 <b>51420</b> Pag. 10.15	 <b>51430</b> Pag. 10.15	 <b>51440</b> Pag. 10.15	 <b>1500</b> Pag. 10.16	 <b>1510</b> Pag. 10.16	 <b>LG 410</b> Pag. 10.16	 <b>LG 500</b> Pag. 10.17	 <b>1600</b> Pag. 10.17	 <b>1610</b> Pag. 10.17
 <b>1612</b> Pag. 10.17	 <b>1613</b> Pag. 10.18	 <b>1700</b> Pag. 10.18	 <b>1710</b> Pag. 10.18	 <b>1750</b> Pag. 10.19	 <b>8610</b> Pag. 10.19			

## RACCORDI A CALZAMENTO

*PUSH-ON FITTINGS*

*ÜBERWURFVERSCHRAUBUNGEN*

*RACCORDS À COIFFE*

*RACORDAJE RÁPIDO*

*CONEXÕES PUSH-ON*



**Serie 1000**

I raccordi Aignep della serie 1000, sfruttano la collaudata tecnologia a "calzamento", per poter connettere in estrema sicurezza tubi termoplastici per applicazioni pneumatiche e fluidiche. Non hanno elementi di tenuta elastomerica e consentono in maniera semplice ed affidabile connessioni in svariati mercati. Il particolare profilo del portagomma consente una migliore connessione dei tubi, mentre l'esagono del dado di serraggio posto in alto semplifica notevolmente il serraggio con la chiave.

### Principali vantaggi

- Tecnologia collaudata
- Compatibilità numerosi fluidi industriali
- Tenuta garantita su differenti tipologie di tubi
- Senza elementi di tenuta (elastomeri)
- Robustezza meccanica
- Silicon Free

### Applicazioni

- Aria Compressa
- Automazione Pneumatica
- Circuiti acqua industriale
- Gas inerti, vapore, fluidi
- Vuoto

The 1000 serie are push-on brass fittings to connect safely with thermoplastic tubes in pneumatic and fluid applications.

The sealing is metallic and the connection is very easy thanks to the particular shape of the hose adaptor.

The hexagon of the locking nut is always on top to facilitate mounting.

### Main advantages

- Tested technology
- All Fluids Compatibility
- Safely connection
- Metallic sealing
- Mechanical resistance
- Silicon Free

### Applications

- Compressed Air
- Pneumatic Automation
- Industrial Cooling
- Inert Gases, Steam, fluids
- Vacuum

Die 1.000-Serie sind Überwurf-Verschraubungen aus Messing, für die sichere Verbindung von thermoplastischen Rohren in Pneumatik- und Fluidik-Anwendungen. Die Dichtung ist metallisch und die Verbindung sehr einfach, dank der besonderen Form des Schlauchadapters.

Zur Erleichterung der Montage ist der Sechskant der immer am Kopf der Sicherungsmutter.

### Hauptvorteile

- Getestete Technologie
- Kompatibel mit allen Medien
- Sichere Verbindung
- Metallische Dichtung
- Mechanische Festigkeit
- Silikonfrei

### Anwendungen

- Druckluft
- Pneumatische Automation
- Industrie-Kühlung
- Inertgase, Dampf
- Vakuum

La série 1000 sont raccords de compression "push on" tout en laiton pour se raccorder en toute sécurité directement avec des tubes en thermoplastiques pour les applications pneumatiques et tous fluides.

L'étanchéité est directe sur le tube et la connexion est facilitée grâce à la forme particulière de la coiffe.

Le six pans de l'écrou de serrage est toujours sur l'extrémité pour faciliter le montage.

### Principaux avantages

- Technologie éprouvée
- Large compatibilité avec les fluides industriels
- Raccordement sécurisé
- Étanchéité métal/métal
- Grande résistance mécanique
- Sans Silicone

### Applications

- Air comprimé
- Automatisation pneumatique
- Refroidissement industriel
- Gaz neutres, vapeur
- Vide

Los racores Aignep de la serie 1000, aprovechan la probada tecnología a "calzamiento", para poder conectar con extremada seguridad tubos termoplásticos para aplicaciones neumáticas y fluidicas.

No disponen de elementos de estanqueidad elastomerica y consienten de modo simple y fiable conexiones en diferentes mercados.

El particular perfil de la espiga consiente una mejor conexión del tubo, mientras que el hexágono de la tuerca de bloqueo en la parte superior simplifica notablemente el bloqueo con la llave.

### Principales ventajas

- Tecnología probada
- Compatibilidad con numerosos fluidos industriales
- Estanqueidad garantizada con diferentes tipos de tubo
- Sin elementos de estanqueidad (elástomeros)
- Robustez mecánica
- Libre de silicona

### Aplicaciones

- Aire comprimido
- Automatización neumática
- Circuitos de agua industrial
- Gases inertes, vapor, fluidos
- Vacío

A série 1000 é uma linha de conexões push-on fabricadas em latão niquelado utilizadas para conectar com segurança tubos termo-plásticos em aplicações pneumáticas e de fluidos.

A vedação é metálica e a conexão é muito facilitada, graças ao design particular do adaptador de encaixe dos tubos.

O sextavado da porca de travamento é localizado sempre no topo para facilitar a montagem.

### Principais vantagens

- Tecnologia testada
- Compatibilidade com todos os fluidos
- Segurança na conexão
- Vedação metálica
- Resistência Mecânica
- Livre de Silicone

### Aplicações

- Ar Comprimido
- Automação pneumática
- Refrigeração Industrial
- Gases Inertes, Vapor
- Vácuo



### CARATTERISTICHE TECNICHE

TECHNICAL CHARACTERISTICS  
TECHNISCHE ANGABEN  
CARACTÉRISTIQUES TECHNIQUES  
CARACTERÍSTICAS TÉCNICAS  
CARACTERÍSTICAS TÉCNICAS



### Norma di Riferimento

Reference standard

Entspricht der Norm

Norme de référence

Normativa de referencia

Norma de referència

1907/2006

REACH

2011/65/CE

RoHS

PED  
2014/68/UE

SILICON  
FREE

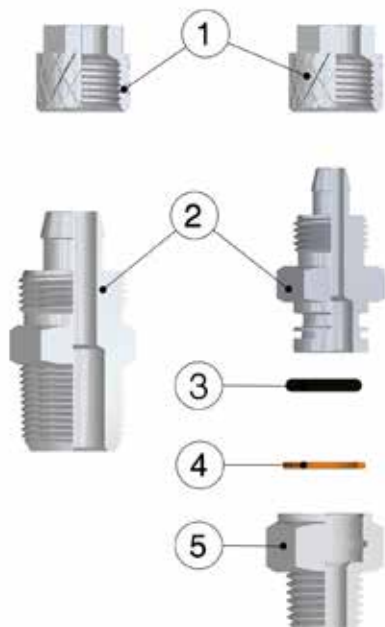

In nessun caso i raccordi "girevoli" devono essere impiegati come giunti rotanti.  
Under no circumstances, the "orienting" fittings can be used as revolving joints.  
In keinem Fall sollten "drehbare" verschraubungen als rotierende eingesetzt werden.  
Ne pas utiliser les raccords orientables comme raccords tournants.  
En ningún caso los racores "giratorios" deben ser empleados como rotativos.  
Em nenhum caso as conexões "orientáveis" devem ser aplicadas como juntas rotativas.

Materiali e Componenti	IT	Component Parts and Materials	GB	Komponenten und Materialien	DE
1 Dado in Ottone Nichelato 2 Corpo in Ottone Nichelato 3 Guarnizione O-Ring in NBR 4 Seeger in Bronzo 5 Basetta in ottone Nichelato		1 Nickel-plated Brass Nut 2 Nickel-plated Brass Body 3 NBR O-RING Seals 4 Bronze Seeger 5 Nickel-plated Brass Base		1 Überwurfmutter Messing vernickelt 2 Körper Messing vernickelt 3 O-Ring NBR 4 Sicherungsring Bronze 5 Grundkörper Messing vernickelt	
Matériaux et Composants	FR	Materiales y Componentes	ES	Materiais e Componentes	PT
1 Ecrou: Laiton nickelé 2 Corps: Laiton nickelé 3 Joint torique: NBR 4 Bague de sécurité: bronze 5 Corps: Laiton nickelé		1 Tuerca en latón niquelado 2 Cuerpo en latón niquelado 3 Junta tórica O-Ring en NBR 4 Seeger en bronce 5 Base en latón niquelado		1 Porca em Latão Niquelado 2 Corpo em Latão Niquelado 3 Vedação O-Ring em NBR 4 Anel de Retenção tipo Seeger em Bronze 5 Base em Latão Niquelado	



### Pressioni e Temperature

Pressioni e temperature sono determinate dal tipo di tubo impiegato, pertanto tali valori sono da definirsi in base alle caratteristiche del tubo stesso.

Per i raccordi nella versione "girevole e O-RING sul filetto" i valori sono: - 20 °C / + 80 °C

### Pressures and Temperatures

The working pressures and working temperatures depend on which type of tube is used, for this reason, the values must be determined in accordance with the tube's features.

For the "orienting and thread with O-RING" fittings, the values are: - 20 °C / + 80 °C

### Druckbereich und Temperatur

Die Drücke und Temperaturen sind vom eingesetzten Rohr abhängig, die Werte werden durch die Eigenschaften des Rohres definiert.

Für Verschraubungen der Version "Drehbar" sind folgende Werte zu beachten: - 20 °C / + 80 °C

### Pressions et Températures

La pression et la température d'utilisation des raccords sont liées au type de tube utilisé. Pour définir ces valeurs, se référer aux caractéristiques techniques du tube utilisé.

Les valeurs suivantes sont à respecter pour les raccords "orientable": - 20 °C / + 80 °C

### Presiones y Temperaturas

Presión y temperatura son determinadas en función del tubo empleado, por tanto estos valores se definen en base a las características del mismo tubo.

Para los racores de la versión "giratoria" los valores son: - 20 °C / + 80 °C

### Pressões e Temperaturas

Pressões e temperaturas são determinadas pelo tipo de tubo empregado, portanto tais valores devem ser definidos com base nas características do tubo em utilização

Para as conexões na versão "orientável e com O-RING na rosca" os valores são: - 20 °C / + 80 °C



### Fluidi compatibili

Aria compressa

Fluidi e liquidi compatibili con il tipo di raccordo.

### Fluids

Compressed air

Fluids and liquids compatible with the connection.

### Geignete Medien

Druckluft

Medien und Flüssigkeiten, die beständig mit den Komponenten der Verschraubungen sind.

### Fluides compatibles

Air comprimé

Fluides et liquides compatibles avec les matériaux constituant les raccords.

### Fluidos compatibles

Aire comprimido

Fluidos y líquidos compatibles con el tipo de conexión.

### Fluidos compatíveis

Ar comprimido

Fluidos e líquidos compatíveis com o tipo de conexão.



<b>Tubi di Collegamento</b>	<b>IT</b>	<b>Connection Tubes</b>	<b>GB</b>	<b>Geeignete Rohre</b>	<b>DE</b>
Tubi in materiale plastico: PA6, PA11, PA12, Polietilene, *Poliuretano, PTFE, FEP. *Utilizzo da 90 a 98 Shore, per la massima prestazione è consigliato 98 Shore A.		Plastic tubes: PA6, PA11, PA12, Polyethylene, *Polyurethane, PTFE, FEP. *Use from 90 to 98 Shore, for maximum performance is recommended 98 Shore A.		Kunststoffrohre: PA6, PA11, PA 12, Polyethylene, *Polyurethan, PTFE, FEP. *Verwenden Sie 90 bis 98 Shore, für maximale Leistung wird 98 Shore A empfohlen.	
<b>Tubes Conseillés</b>	<b>FR</b>	<b>Tubos de Conexión</b>	<b>ES</b>	<b>Tubos de Conexão</b>	<b>PT</b>
Tubes plastiques: PA6, PA11, PA12, Polyéthylène, *Polyuréthane, PTFE, FEP. *Utilisation de 90 à 98 Shore, pour une performance maximale recommandée 98 Shore A.		Tubos en material plástico: PA6, PA11, PA 12, Polietileno, *Poliuretano, PTFE, FEP. *Uso de 90 a 98 Shore, para un máximo rendimiento se recomienda 98 Shore A.		Tubos em material plástico: PA6, PA11, PA12, Polietileno, *Poliuretano, PTFE, FEP. *Uso de 90 a 98 Shore, para o desempenho máximo é recomendado 98 Shore A.	



<b>Filettatura</b>	<b>IT</b>	<b>Threads</b>	<b>GB</b>	<b>Gewindearten</b>	<b>DE</b>
Gas conica conforme ISO 7.1, BS 21, DIN 2999. Gas cilindrica conforme ISO 228 Classe A. Metrica conforme ISO R/262.		Tapered gas in conformity with ISO 7.1, BS 21, DIN 2999. Parallel gas in conformity with ISO 228 Class A. Metric in conformity with ISO R/262.		Konisches Gewinde nach Norm ISO 7.1, BS 21, DIN 2999. Zylindrisches Gewinde nach Norm ISO 228 Classe A. Metrisches Gewinde nach Norm ISO R/262.	
<b>Filetages</b>	<b>FR</b>	<b>Roscas</b>	<b>ES</b>	<b>Roscas</b>	<b>PT</b>
Filetage conique conforme: ISO 7.1, BS 21, DIN 2999. Filetage cylindrique conforme: ISO 228 Classe A. Filetage métrique conforme: ISO R/262.		Gas cónica conforme ISO 7.1, BS 21, DIN 2999. Gas cilíndrica conforme ISO 228 Clase A. Métrica conforme ISO R/262.		Gas cônica conforme ISO 7.1, BS 21, DIN 2999. Gas paralela conforme ISO 228 Classe A. Métrica conforme ISO R/262.	



**Misure specifiche per tubi in POLIURETANO**

- Particular sizes for the POLYURETHANE tubing
- Spezial Abmessungen für POLYURETHAN Rohre
- Dimensions spécifiques pour tube POLYURETHANE
- Medidas específicas para tubo en POLIURETANO
- Tamanhos específicos para tubos de POLIURETANO

Polyurethane tubing	Suggested size
8/5 - 8/5.5	<b>8/6</b>
12/9	<b>12/8</b>



**Montaggio**

- Assembling
- Montageanleitung
- Assemblage
- Montaje
- Montagem



- 1** Inserire il tubo nel dado.  
 Insert the tube on the nut.  
 Schieben sie das Rohr durch die Überwurfmutter.  
 Insérer le tube à travers l'écrou.  
 Insertar el tubo en la tuerca.  
 Insira o tubo na porca.

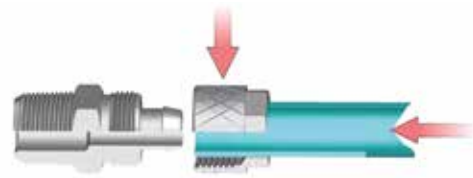

- 2** Infilare il tubo sul cono di calzamento.  
 Thread the tube on the fitting cone.  
 Stecken sie das Rohr auf den Konus der Verschraubung.  
 Insérer le tube sur la canule.  
 Introducir el tubo en el cono del racor.  
 Engate o tubo no cone de engate da conexão.

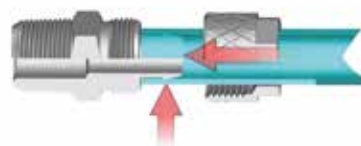

- 3** Avvitare il dado di bloccaggio a mano o con una chiave.  
 Tighten the nut by hand or with a spanner.  
 Ziehen sie die Überwurf-mutter von Hand oder mit einem Schlüssel an.  
 Assembler et serrer l'écrou à la main ou avec une clé.  
 Atornillar la tuerca de bloqueo a mano o con una llave.  
 Aperte a porca apertando com a mão ou com uma chave adequada.



**1000**

**RACCORDO DIRITTO MASCHIO CONICO**

STRAIGHT MALE ADAPTOR (TAPER)  
 GERADE EINSCHRAUBVERSCHRAUBUNG KONISCH  
 RACCORD DROIT MÂLE CONIQUE  
 RACOR RECTO MACHO CÓNICO  
 CONEXÃO RETA MACHO COM ROSCA CÔNICA

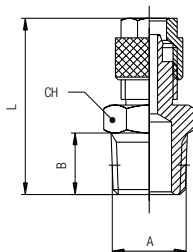

Code	Tube	A	B	L	CH	Pack.
01000 00 001	4/2.7	1/8	7.5	23.5	12	10
01000 00 002	5/3	1/8	7.5	23	12	10
01000 00 003	6/4	1/8	7.5	25.6	12	10
01000 00 004	6/4	1/4	11	29.6	14	10
01000 00 005	6/4	3/8	11.5	30	17	10
01000 00 006	8/6	1/8	7.5	26.9	14	10
01000 00 007	8/6	1/4	11	30.9	14	10
01000 00 008	8/6	3/8	11.5	31.4	17	10
01000 00 009	8/6	1/2	14	34	22	10
01000 00 010	10/8	1/8	7.5	29	14	10
01000 00 011	10/8	1/4	11	33	14	10
01000 00 012	10/8	3/8	11.5	33.5	17	10
01000 00 013	10/8	1/2	14	36.5	22	10
01000 00 014	12/10	3/8	11.5	35	17	10
01000 00 015	12/10	1/2	14	38	22	10
01000 00 016	15/12.5	1/2	14	40	22	10

**1010**

**RACCORDO DIRITTO ORIENTABILE MASCHIO CONICO**

ORIENTING STRAIGHT MALE ADAPTOR (TAPER)  
 GERADE EINSCHRAUBVERSCHRAUBUNG KONISCH (DREHBAR)  
 RACCORD ORIENTABLE DROIT MÂLE CONIQUE  
 RACOR RECTO ORIENTABLE MACHO CÓNICO  
 CONEXÃO RETA MACHO ORIENTÁVEL COM ROSCA CÔNICA

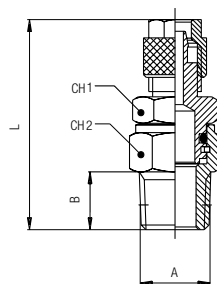

Code	Tube	A	B	L	CH1	CH2	Pack.
01010 00 001	6/4	1/8	7.5	33.5	12	13	10
01010 00 002	6/4	1/4	11	40	14	15	10
01010 00 003	8/6	1/8	7.5	33.5	12	13	10
01010 00 004	8/6	1/4	11	40	14	15	10
* 01010 00 007	10/6.5	1/4	11	41	14	15	10
01010 00 005	10/8	1/4	11	41	14	15	10
* 01010 00 008	12/8	3/8	11.5	43.5	17	17	10
01010 00 006	12/10	3/8	11.5	43.5	17	17	10

\* Misure specifiche per tubi in POLIURETANO.  
 \* Particular sizes for the POLYURETHANE tubing.  
 \* Spezial Abmessungen für POLYURETHAN Rohre.  
 \* Dimensions spécifiques pour tube POLYURETHANE.  
 \* Medidas específicas para tubo en POLIURETANO.  
 \* Tamanhos específicos para tubos de POLIURETANO.

**1015**

**RACCORDO DIRITTO ORIENTABILE MASCHIO CILINDRICO**

ORIENTING STRAIGHT MALE ADAPTOR (PARALLEL)  
 GERADE EINSCHRAUBVERSCHRAUBUNG ZYLINDRISCH (DREHBAR)  
 RACCORD ORIENTABLE DROIT MÂLE CYLINDRIQUE  
 RACOR RECTO ORIENTABLE MACHO CILÍNDRICO CON TÓRICA  
 CONEXÃO RETA MACHO ORIENTÁVEL COM ROSCA PARALELA

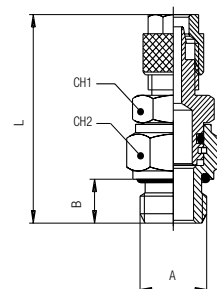

Code	Tube	A	B	L	CH1	CH2	Pack.
01015 00 001	6/4	1/8	5.4	34	12	13	10
01015 00 002	6/4	1/4	7.1	38	14	16	10
01015 00 003	8/6	1/8	5.4	34	12	13	10
01015 00 004	8/6	1/4	7.1	38	14	16	10
* 01015 00 005	10/6.5	1/4	7.1	40	14	16	10
01015 00 006	10/8	1/4	7.1	39	14	16	10
* 01015 00 007	12/8	3/8	8.1	42.5	17	18	10
01015 00 008	12/10	3/8	8.1	42.5	17	18	10

\* Misure specifiche per tubi in POLIURETANO.  
 \* Particular sizes for the POLYURETHANE tubing.  
 \* Spezial Abmessungen für POLYURETHAN Rohre.  
 \* Dimensions spécifiques pour tube POLYURETHANE.  
 \* Medidas específicas para tubo en POLIURETANO.  
 \* Tamanhos específicos para tubos de POLIURETANO.

## 1020

New

### RACCORDO DIRITTO MASCHIO CILINDRICO

STRAIGHT MALE ADAPTOR (PARALLEL)  
 GERADE EINSCHRAUBVERSCHRÄUBUNG ZYLINDRISCH  
 RACCORD DROIT MÂLE, CYLINDRIQUE  
 RACOR RECTO MACHO CILÍNDRICO CON TÓRICA  
 CONEXÃO RETA MACHO COM ROSCA PARALELA

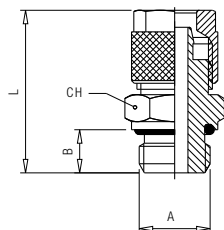

Code	Tube	A	B	L	CH	Pack.
01020 00 001	4/2.7	1/8	5.4	23	13	10
01020 00 002	5/3	1/8	5.4	25.1	13	10
01020 00 003	6/4	1/8	5.4	25.1	13	10
01020 00 004	6/4	1/4	7.1	28.1	16	10
01020 00 005	6/4	3/8	8.1	29.1	19	10
01020 00 006	6/4	1/2	9.6	32	24	10
01020 00 007	8/6	1/8	5.4	26.4	14	10
01020 00 008	8/6	1/4	7.1	29.4	16	10
01020 00 009	8/6	3/8	8.1	30.4	19	10
01020 00 010	8/6	1/2	9.6	32	24	10
01020 00 020	10/6.5	1/4	7.1	31.5	16	10
01020 00 021	10/6.5	3/8	8.1	32.5	19	10
01020 00 011	10/8	1/8	5.4	28.5	14	10
01020 00 012	10/8	1/4	7.1	31.5	16	10
01020 00 013	10/8	3/8	8.1	32.5	19	10
01020 00 014	10/8	1/2	9.6	34.5	24	10
01020 00 022	12/8	3/8	8.1	32.5	19	10
01020 00 023	12/8	1/2	9.6	34.5	24	10
01020 00 015	12/10	3/8	8.1	34	19	10
01020 00 016	12/10	1/2	9.6	36	24	10
01020 00 017	15/12.5	1/2	9.6	38	24	10

## 1021

### RACCORDO DIRITTO MASCHIO CON FILETTATURE METRICHE

STRAIGHT MALE ADAPTOR WITH METRIC THREAD  
 GERADE EINSCHRAUBVERSCHRÄUBUNG METRISCHE GEWINDE  
 RACCORD DROIT MÂLE, FILETAGE METRIQUE  
 RACOR RECTO MACHO CON TÓRICA CON ROSCA MÉTRICA  
 CONEXÃO RETA MACHO COM ROSCA MÉTRICA

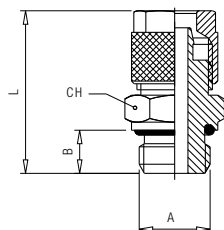

Code	Tube	A	B	L	CH	Pack.
01021 00 001	4/2.7	M5	3.6	20.5	8	10
01021 00 002	4/2.7	M6	3.6	21.5	8	10
01021 00 003	5/3	M5	3.6	23.1	8	10
01021 00 004	5/3	M6	3.6	23.1	8	10
01021 00 005	6/4	M5	3.6	23.1	8	10
01021 00 006	6/4	M6	3.6	23.1	8	10
01021 00 007	6/4	M12x1	7.3	28.1	15	10
01021 00 008	6/4	M12x1.25	7.3	28.1	15	10
01021 00 009	6/4	M12x1.5	7.3	28.1	15	10

## 1025

### RACCORDO DIRITTO MASCHIO CONICO + DADO CON MOLLA

STRAIGHT MALE ADAPTOR (TAPER) + NUT WITH SPRING  
 GERADE VERSCHRÄUBUNG KONISCH + KNICKSCHUTZFEDER  
 RACCORD DROIT MÂLE, CONIQUE AVEC RESSORT DE PROTECTION  
 RACOR RECTO MACHO CÔNICO + TUERCA CON MUELLE  
 CONEXÃO RETA MACHO COM ROSCA CÔNICA + PORCA COM MOLA

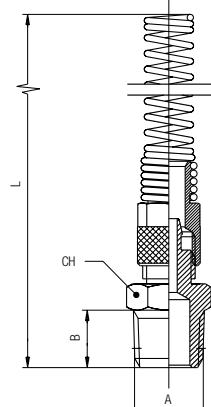

Code	Tube	A	B	L	CH	Pack.
01025 00 001	6/4	1/8	7.5	108	12	10
01025 00 002	6/4	1/4	11	112.5	14	10
01025 00 003	8/6	1/8	7.5	113.5	14	10
01025 00 004	8/6	1/4	11	118	14	10
01025 00 005	8/6	3/8	11.5	119	17	10
01025 00 006	8/6	1/2	14	121	22	10
01025 00 007	10/8	1/8	7.5	122	14	10
01025 00 008	10/8	1/4	11	126	14	10
01025 00 009	10/8	3/8	11.5	127	17	10
01025 00 010	10/8	1/2	14	130	22	10
01025 00 011	12/10	3/8	11.5	134	17	10
01025 00 012	12/10	1/2	14	137	22	10

Molla Acciaio Inox AISI 304 - EN 1.4301  
 Stainless Steel Spring AISI 304 - EN 1.4301  
 Edelstahlfeder AISI 304 - EN 1.4301  
 Ressort Acier Inoxydable AISI 304 - EN 1.4301  
 Muelle Acero Inoxidable AISI 304 - EN 1.4301  
 Mola Aço Inoxidável AISI 304 - EN 1.4301

## 1026

### RACCORDO DIRITTO ORIENTABILE MASCHIO CONICO + DADO CON MOLLA

ORIENTING STRAIGHT MALE ADAPTOR (TAPER) + NUT WITH SPRING  
 GERADE VERSCHRAUBUNG KONISCH (DREHBAR) + KNICKSCHUTZFEDER  
 RACCORD ORIENTABLE DROIT MÂLE, CONIQUE AVEC RESSORT DE PROTECTION  
 RACOR RECTO ORIENTABLE MACHO CÓNICO + TUERCA CON MUELLE  
 CONEXÃO RETA ORIENTÁVEL MACHO COM ROSCA CÔNICA + PORCA COM MOLA

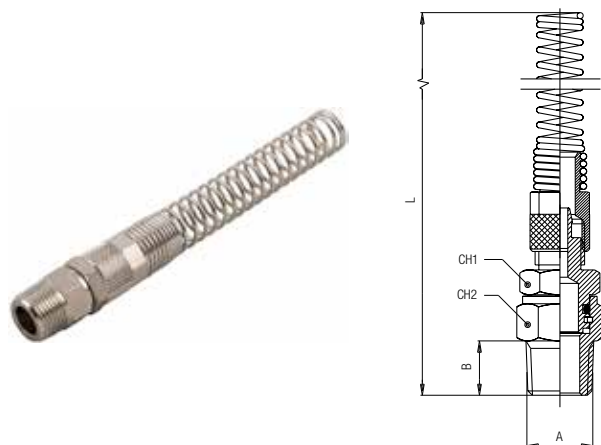

Code	Tube	A	B	L	CH1	CH2	Pack.
01026 00 001	6/4	1/8	7.5	117.5	12	13	10
01026 00 002	6/4	1/4	11	121	14	15	10
01026 00 003	8/6	1/8	7.5	121	12	13	10
01026 00 004	8/6	1/4	11	128	14	15	10
* 01026 00 005	10/6.5	1/4	11	135	14	15	10
01026 00 006	10/8	1/4	11	136	14	15	10
* 01026 00 007	12/8	3/8	11.5	144	17	17	10
01026 00 008	12/10	3/8	11.5	144	17	17	10

\* Misure specifiche per tubi in POLIURETANO.  
 \* Particular sizes for the POLYURETHANE tubing.  
 \* Spezial Abmessungen für POLYURETHAN Rohre.  
 \* Dimensions spécifiques pour tube POLYURETHANE.  
 \* Medidas específicas para tubo en POLIURETANO.  
 \* Tamanhos específicos para tubos de POLIURETANO.

**Molla Acciaio Inox AISI 304 - EN 1.4301**  
 Stainless Steel Spring AISI 304 - EN 1.4301  
 Edelstahlfeder AISI 304 - EN 1.4301  
 Ressort Acier Inoxydable AISI 304 - EN 1.4301  
 Muelle Acero Inoxidable AISI 304 - EN 1.4301  
 Mola Aço Inoxidável AISI 304 - EN 1.4301

## 1027

### RACCORDO DIRITTO ORIENTABILE MASCHIO CILINDRICO + DADO CON MOLLA

ORIENTING STRAIGHT MALE ADAPTOR (PARALLEL) + NUT WITH SPRING  
 GERADE VERSCHRAUBUNG ZYLINDRISCH (DREHBAR) + KNICKSCHUTZFEDER  
 RACCORD ORIENTABLE DROIT MÂLE, CYLINDRIQUE AVEC RESSORT DE PROTECTION  
 RACOR RECTO ORIENTABLE MACHO CILÍNDRICO CON TÓRICA + TUERCA CON MUELLE  
 CONEXÃO RETA ORIENTÁVEL MACHO COM ROSCA PARALELA + PORCA COM MOLA

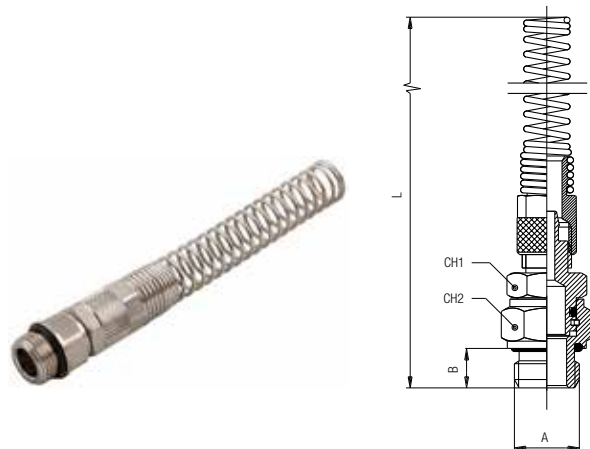

Code	Tube	A	B	L	CH1	CH2	Pack.
01027 00 001	6/4	1/8	5.4	116	12	13	10
01027 00 002	6/4	1/4	7.1	121	14	16	10
01027 00 003	8/6	1/8	5.4	122	12	13	10
01027 00 004	8/6	1/4	7.1	126	14	16	10
* 01027 00 005	10/6.5	1/4	7.1	134	14	16	10
01027 00 006	10/8	1/4	7.1	134	14	16	10
* 01027 00 007	12/8	3/8	8.1	143	17	18	10
01027 00 008	12/10	3/8	8.1	142	17	18	10

\* Misure specifiche per tubi in POLIURETANO.  
 \* Particular sizes for the POLYURETHANE tubing.  
 \* Spezial Abmessungen für POLYURETHAN Rohre.  
 \* Dimensions spécifiques pour tube POLYURETHANE.  
 \* Medidas específicas para tubo en POLIURETANO.  
 \* Tamanhos específicos para tubos de POLIURETANO.

**Molla Acciaio Inox AISI 304 - EN 1.4301**  
 Stainless Steel Spring AISI 304 - EN 1.4301  
 Edelstahlfeder AISI 304 - EN 1.4301  
 Ressort Acier Inoxydable AISI 304 - EN 1.4301  
 Muelle Acero Inoxidable AISI 304 - EN 1.4301  
 Mola Aço Inoxidável AISI 304 - EN 1.4301

## 1028

### RACCORDO DIRITTO MASCHIO CILINDRICO + DADO CON MOLLA

STRAIGHT MALE ADAPTOR (PARALLEL) + NUT WITH SPRING  
 GERADE VERSCHRAUBUNG ZYLINDRISCH + KNICKSCHUTZFEDER  
 RACCORD DROIT MÂLE, CYLINDRIQUE AVEC RESSORT DE PROTECTION  
 RACOR RECTO MACHO CILÍNDRICO CON TÓRICA + TUERCA CON MUELLE  
 CONEXÃO RETA MACHO COM ROSCA PARALELA + PORCA COM MOLA

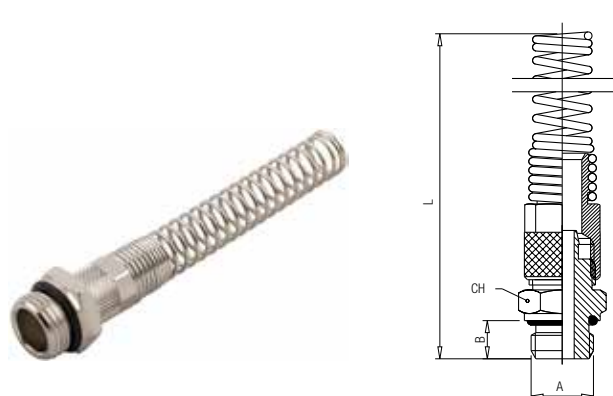

Code	Tube	A	B	L	CH	Pack.
01028 00 001	6/4	1/8	5.4	109	13	10
01028 00 002	6/4	1/4	7.1	111	16	10
01028 00 003	6/4	3/8	8.1	112	19	10
01028 00 004	6/4	1/2	9.6	114	24	10
01028 00 005	8/6	1/8	5.4	114	14	10
01028 00 006	8/6	1/4	7.1	116.5	16	10
01028 00 007	8/6	3/8	8.1	117.5	19	10
01028 00 008	8/6	1/2	9.6	119.5	24	10
01028 00 009	10/8	1/8	5.4	121.5	14	10
01028 00 010	10/8	1/4	7.1	125.5	16	10
01028 00 011	10/8	3/8	8.1	125.5	19	10
01028 00 012	10/8	1/2	9.6	128.5	24	10
01028 00 013	12/10	3/8	8.1	133	19	10
01028 00 014	12/10	1/2	9.6	134.5	24	10

**Molla Acciaio Inox AISI 304 - EN 1.4301**  
 Stainless Steel Spring AISI 304 - EN 1.4301  
 Edelstahlfeder AISI 304 - EN 1.4301  
 Ressort Acier Inoxydable AISI 304 - EN 1.4301  
 Muelle Acero Inoxidable AISI 304 - EN 1.4301  
 Mola Aço Inoxidável AISI 304 - EN 1.4301



## 1029

### RACCORDO DIRITTO MASCHIO CON FILETTATURE METRICHE + DADO CON MOLLA

STRAIGHT MALE ADAPTOR WITH METRIC THREAD + NUT WITH SPRING  
 GERADE VERSCHRAUBUNG METRISCHE GEWINDE + KNICKSCHUTZFEDER  
 RACCORD DROIT MÂLE, FILETAGE MÉTRIQUE AVEC RESSORT DE PROTECTION  
 RACOR RECTO MACHO CON ROSCA MÉTRICA + TUERCA CON MUELLE  
 CONEXÃO RETA MACHO COM ROSCA MÉTRICA + PORCA COM MOLA

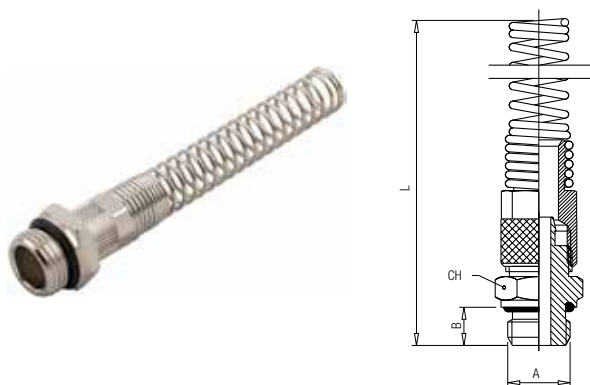

Code	Tube	A	B	L	CH	Pack.
01029 00 001	6/4	M12x1	7.3	111	15	10
01029 00 002	6/4	M12x1.25	7.3	111	15	10
01029 00 003	6/4	M12x1.5	7.3	111	15	10

Molla Acciaio Inox AISI 304 - EN 1.4301  
 Stainless Steel Spring AISI 304 - EN 1.4301  
 Edelstahlfeder AISI 304 - EN 1.4301  
 Ressort Acier Inoxydable AISI 304 - EN 1.4301  
 Muelle Acero Inoxidable AISI 304 - EN 1.4301  
 Mola Aço Inoxidável AISI 304 - EN 1.4301

## 1030

### RACCORDO DIRITTO FEMMINA

STRAIGHT FEMALE ADAPTOR  
 AUFSCHRAUBVERSCHRAUBUNG  
 RACCORD DROIT, TARAUEE  
 RACOR RECTO HEMBRA  
 CONEXÃO RETA COM ROSCA FÊMEA

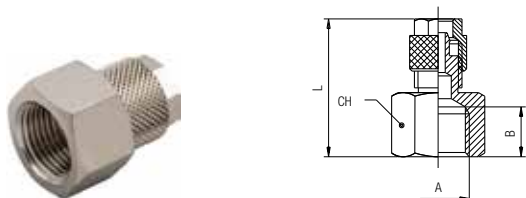

Code	Tube	A	B	L	CH	Pack.
01030 00 001	6/4	1/8	8.5	23.3	14	10
01030 00 002	6/4	1/4	11	27	17	10
01030 00 003	6/4	3/8	11.5	28	22	10
01030 00 004	8/6	1/8	8	24.7	14	10
01030 00 005	8/6	1/4	11	28.7	17	10
01030 00 006	8/6	3/8	11.5	29.2	22	10
01030 00 007	8/6	1/2	15.5	33	24	10
01030 00 008	10/8	1/4	11	30.5	17	10
01030 00 009	10/8	3/8	11.5	31	22	10
01030 00 010	10/8	1/2	15.5	34.5	24	10
01030 00 011	12/10	3/8	11.5	32.5	22	10

## 1035

### RACCORDO DIRITTO FEMMINA + DADO CON MOLLA

STRAIGHT FEMALE ADAPTOR + NUT WITH SPRING  
 AUFSCHRAUBVERSCHRAUBUNG + KNICKSCHUTZFEDER  
 RACCORD DROIT, TARAUEE AVEC RESSORT DE PROTECTION  
 RACOR RECTO HEMBRA + TUERCA CON MUELLE  
 CONEXÃO RETA COM ROSCA FÊMEA + PORCA COM MOLA

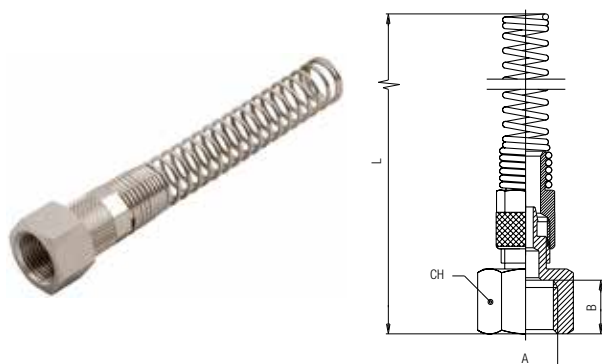

Code	Tube	A	B	L	CH	Pack.
01035 00 001	6/4	1/8	8.5	106	14	10
01035 00 002	6/4	1/4	11	109	17	10
01035 00 003	6/4	3/8	11.5	110	22	10
01035 00 004	8/6	1/8	8	112	14	10
01035 00 005	8/6	1/4	11	115.5	17	10
01035 00 006	8/6	3/8	11.5	116	22	10
01035 00 007	8/6	1/2	15.5	119.5	24	10
01035 00 008	10/8	1/4	11	123	17	10
01035 00 009	10/8	3/8	11.5	124.5	22	10
01035 00 010	10/8	1/2	15.5	128.5	24	10
01035 00 011	12/10	3/8	11.5	131	22	10

Molla Acciaio Inox AISI 304 - EN 1.4301  
 Stainless Steel Spring AISI 304 - EN 1.4301  
 Edelstahlfeder AISI 304 - EN 1.4301  
 Ressort Acier Inoxydable AISI 304 - EN 1.4301  
 Muelle Acero Inoxidable AISI 304 - EN 1.4301  
 Mola Aço Inoxidável AISI 304 - EN 1.4301

## 1040

### RACCORDO DIRITTO INTERMEDIO

STRAIGHT CONNECTOR  
 VERBINDUNGSVERSCHRAUBUNG  
 RACCORD UNION DOUBLE  
 RACOR RECTO INTERMEDIO  
 CONEXÃO RETA TUBO-TUBO

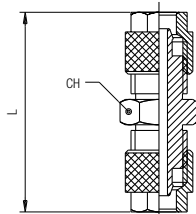

Code	Tube	Tube	L	CH	Pack.
01040 00 001	4/2.7	4/2.7	27.5	8	10
01040 00 002	5/3	5/3	31.7	8	10
01040 00 003	6/4	5/3	32.2	12	10
01040 00 004	6/4	6/4	32.2	12	10
01040 00 005	8/6	6/4	33.5	12	10
01040 00 006	8/6	8/6	34.8	12	10
01040 00 007	10/8	6/4	35.6	14	10
01040 00 008	10/8	8/6	36.9	14	10
01040 00 009	10/8	10/8	39	14	10
01040 00 010	12/10	12/10	43	17	10
01040 00 011	15/12.5	15/12.5	47	22	10

## 1050

### RACCORDO DIRITTO INTERMEDIO DI ATTRAVERSAMENTO

BULKHEAD CONNECTOR  
 SCHOTTVERSCHRAUBUNG  
 RACCORD TRAVERSÉE DE CLOISON  
 RACOR RECTO INTERMEDIO PASATABIQUES  
 CONEXÃO PASSA-MURO RETA TUBO-TUBO

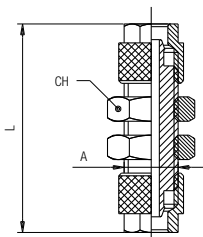

Code	Tube	Tube	A	L	CH	Pack.
01050 00 001	4/2.7	4/2.7	M6x0.5	35	10	10
01050 00 002	5/3	5/3	M7x0.75	35	10	10
01050 00 003	6/4	5/3	M10x1	45.5	14	10
01050 00 004	6/4	6/4	M10x1	45.5	14	10
01050 00 005	8/6	6/4	M12x1	47.3	17	10
01050 00 006	8/6	8/6	M12x1	48.4	17	10
01050 00 007	10/8	6/4	M14x1	49.8	17	10
01050 00 008	10/8	8/6	M14x1	51.2	17	10
01050 00 009	10/8	10/8	M14x1	52	17	10
01050 00 010	12/10	12/10	M16x1	57	19	10
01050 00 011	15/12.5	15/12.5	M20x1	59	24	10

## 1100

### RACCORDO A L MASCHIO CONICO

ELBOW MALE ADAPTOR (TAPER)  
 WINKELVERSCHRAUBUNG KONISCH (NICHT DREHBAR)  
 EQUERRE MÂLE NON ORIENTABLE, CONIQUE  
 RACOR A L MACHO CÔNICO  
 CONEXÃO EM "L" COM ROSCA MACHO CÔNICA

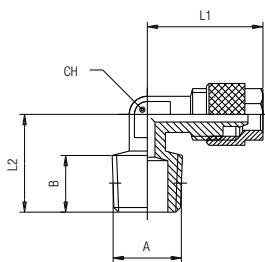

Code	Tube	A	B	L1	L2	CH	Pack.
01100 00 001	4/2.7	1/8	7.5	19.5	15	8	10
01100 00 002	5/3	1/8	7.5	19.5	15	8	10
01100 00 003	6/4	1/8	7.5	19.5	15	8	10
01100 00 004	6/4	1/4	11	20.6	19	8	10
01100 00 005	6/4	3/8	11.5	21	21	9	10
01100 00 006	8/6	1/8	7.5	19.9	16.5	9	10
01100 00 007	8/6	1/4	11	21.9	19	9	10
01100 00 008	8/6	3/8	11.5	23.4	21	9	10
01100 00 009	8/6	1/2	14	26	28	16	10
01100 00 010	10/8	1/8	7.5	25	18	11	10
01100 00 011	10/8	1/4	11	24	22	11	10
01100 00 012	10/8	3/8	12.5	25.5	22.5	11	10
01100 00 013	10/8	1/2	14	28	28	16	10
01100 00 014	12/10	3/8	11.5	27	22.5	13	10
01100 00 015	12/10	1/2	14	30	28	16	10
01100 00 016	15/12.5	1/2	14	31.5	28	16	10

# 1101

## RACCORDO A L MASCHIO METRICO

ELBOW MALE ADAPTOR WITH METRIC THREAD  
 WINKELVERSCHRAUBUNG METRISCHE GEWINDE (NICHT DREHBAR)  
 EQUERRE MÂLE NON ORIENTABLE, FILETAGE MÉTRIQUE  
 RACOR A L MACHO CON ROSCA MÉTRICA  
 CONEXÃO EM "L" COM ROSCA MACHO METRICA

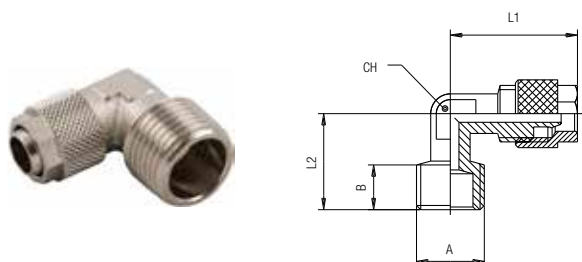

Code	Tube	A	B	L1	L2	CH	Pack.
01101 00 001	6/4	M12x1	11	20.6	19	8	10
01101 00 002	6/4	M12x1.25	11	20.6	19	8	10
01101 00 003	6/4	M12x1.5	11	20.6	19	8	10

# 1110

## RACCORDO A L ORIENTABILE MASCHIO CONICO

ORIENTING ELBOW MALE ADAPTOR (TAPER)  
 WINKELVERSCHRAUBUNG KONISCH (DREHBAR)  
 EQUERRE MÂLE ORIENTABLE, CONIQUE  
 RACOR A L ORIENTABLE MACHO CÓNICO  
 CONEXÃO EM "L" ORIENTÁVEL COM ROSCA MACHO CÔNICA

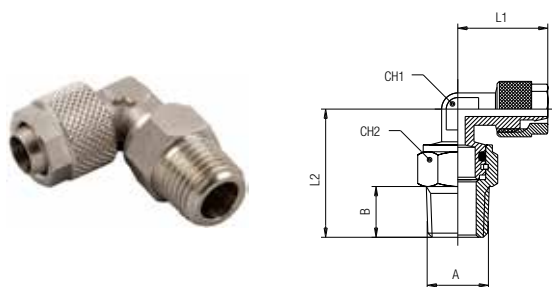

Code	Tube	A	B	L1	L2	CH1	CH2	Pack.
01110 00 006	4/2.7	1/8	7.5	20	22.5	8	13	10
01110 00 001	6/4	1/8	7.5	20.6	22.5	8	13	10
01110 00 002	6/4	1/4	11	20.6	28	8	15	10
01110 00 003	8/6	1/8	7.5	21.6	22.5	9	13	10
01110 00 004	8/6	1/4	11	23.1	28.5	9	15	10
01110 00 005	10/8	1/4	11	24	30.5	11	15	10

# 1115

**New**

## RACCORDO A L ORIENTABILE MASCHIO CILINDRICO

ORIENTING ELBOW MALE ADAPTOR (PARALLEL)  
 WINKELVERSCHRAUBUNG ZYLINDRISCH (DREHBAR)  
 EQUERRE MÂLE ORIENTABLE, CYLINDRIQUE  
 RACOR A L ORIENTABLE MACHO CILÍNDRICO CON TÓRICA  
 CONEXÃO EM "L" ORIENTÁVEL COM ROSCA MACHO PARALELA

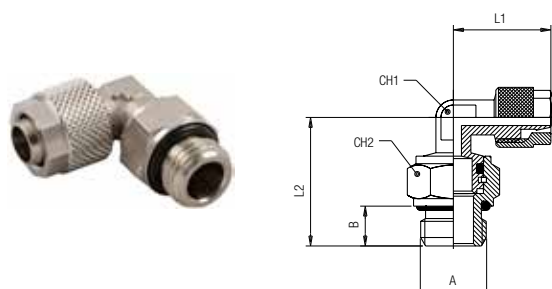

Code	Tube	A	B	L1	L2	CH1	CH2	Pack.
01115 00 006	4/2.7	1/8	5.4	18.5	22	8	13	10
01115 00 011	6/4	M5	3.6	19.5	20	8	8	10
01115 00 001	6/4	1/8	5.4	20.6	22	8	13	10
01115 00 002	6/4	1/4	7.1	20.6	26	8	16	10
01115 00 003	8/6	1/8	5.4	21.6	21.6	9	13	10
01115 00 004	8/6	1/4	7.1	23.1	26.5	9	16	10
01115 00 014	10/6.5	1/4	7.1	24	27.5	11	16	10
01115 00 015	10/6.5	3/8	8.1	24	29.5	11	18	10
01115 00 005	10/8	1/4	7.1	24	27.5	11	16	10
01115 00 013	10/8	3/8	8.1	24	29.9	11	18	10
01115 00 018	12/8	3/8	8.1	25.5	31.1	13	18	10
01115 00 019	12/8	1/2	9	25.5	32.1	13	22	10
01115 00 016	12/10	3/8	8.1	25.5	31.1	13	18	10
01115 00 017	12/10	1/2	9.6	25.5	32.1	13	22	10

## 1120

### RACCORDO A L FEMMINA

ELBOW FEMALE ADAPTOR

AUFSCHRAUB-WINKELSCHRAUBUNG (NICHT DREHBAR)

EQUERRE FEMELLE ORIENTABLE

RACOR A L HEMBRA

CONEXÃO EM "L" COM ROSCA FÊMEA

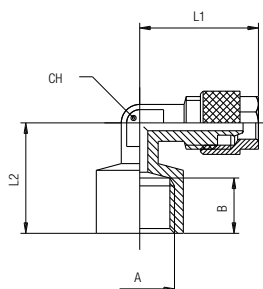

Code	Tube	A	B	L1	L2	CH	Pack.
01120 00 001	5/3	1/8	8.5	20.6	18	8	10
01120 00 002	6/4	1/8	8.5	20.6	18	8	10
01120 00 003	6/4	1/4	10.5	21	21	9	10
01120 00 004	8/6	1/8	8.5	21.9	19	9	10
01120 00 005	8/6	1/4	10.5	23.4	21	9	10
01120 00 006	10/8	1/4	10.5	25.5	22.5	11	10
01120 00 007	10/8	3/8	11.5	28	27	16	10

## 1130

### RACCORDO A L INTERMEDIO

ELBOW CONNECTOR

WINKELVERSCHRAUBUNG

RACCORD EQUERRE

RACOR A L INTERMEDIO

CONEXÃO EM "L" TUBO-TUBO

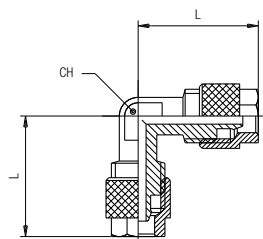

Code	Tube	Tube	L	CH	Pack.
01130 00 001	4/2.7	4/2.7	20	8	10
01130 00 002	5/3	5/3	20.6	8	10
01130 00 003	6/4	6/4	20.6	8	10
01130 00 004	8/6	6/4	21.9	9	10
01130 00 005	8/6	8/6	21.9	9	10
01130 00 006	10/8	10/8	25.5	11	10
01130 00 007	12/10	12/10	27	13	10
01130 00 008	15/12.5	15/12.5	33.5	16	10

## 1200

### RACCORDO A T MASCHIO CONICO

TEE MALE ADAPTOR (TAPER) - CENTRE LEG

T-EINSCHRAUBVERSCHRAUBUNG KONISCH (NICHT DREHBAR)

TÉ NON ORIENTABLE À PIQUAGE MÂLE CENTRAL, CONIQUE

RACOR A T MACHO CENTRAL CÔNICO

CONEXÃO EM "T" COM ROSCA MACHO CÔNICA

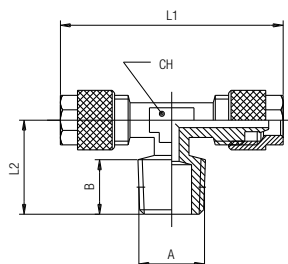

Code	Tube	A	B	L1	L2	CH	Pack.
01200 00 001	4/2.7	1/8	7.5	37	15.5	8	10
01200 00 002	5/3	1/8	7.5	39	15.5	8	10
01200 00 003	6/4	1/8	7.5	39	15.5	8	10
01200 00 004	6/4	1/4	11	41.2	19	8	10
01200 00 005	8/6	1/8	7.5	39.8	16.5	9	10
01200 00 006	8/6	1/4	11	43.8	20.5	9	10
01200 00 007	10/8	1/8	7.5	48	19	11	10
01200 00 008	10/8	1/4	11	48	22	11	10
01200 00 009	10/8	3/8	11.5	51	22	11	10
01200 00 010	12/10	3/8	11.5	54	22.5	14	10
01200 00 011	15/12.5	1/2	14	63	28	16	10

## 1210

### RACCORDO A T ORIENTABILE MASCHIO CONICO

ORIENTING TEE MALE ADAPTOR (TAPER) - CENTRE LEG

T-EINSCHRAUBVERSCHRAUBUNG KONISCH (DREHBAR)

TÉ ORIENTABLE À PIQUAGE MÂLE CENTRAL, CONIQUE

RACOR A T ORIENTABLE MACHO CENTRAL CÓNICO

CONEXÃO EM "T" ORIENTÁVEL COM ROSCA MACHO CÔNICA

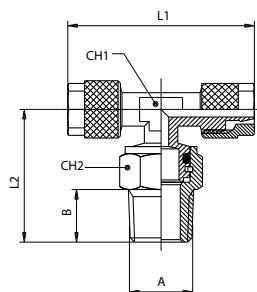

Code	Tube	A	B	L1	L2	CH1	CH2	Pack.
01210 00 001	6/4	1/8	7.5	41.2	22.5	8	13	10
01210 00 002	6/4	1/4	11	41.2	28	8	15	10
01210 00 003	8/6	1/8	7.5	43.2	24.5	9	13	10
01210 00 004	8/6	1/4	11	43.2	29.5	9	15	10
01210 00 005	10/8	1/4	11	48	29.5	11	15	10

## 1215

### RACCORDO A T ORIENTABILE MASCHIO CILINDRICO

ORIENTING TEE MALE ADAPTOR (PARALLEL) - CENTRE LEG

T-EINSCHRAUBVERSCHRAUBUNG ZYLINDRISCH (DREHBAR)

TÉ ORIENTABLE À PIQUAGE MÂLE CENTRAL, CYLINDRIQUE

RACOR A T ORIENTABLE MACHO CENTRAL CILÍNDRICO CON TÓRICA

CONEXÃO EM "T" ORIENTÁVEL COM ROSCA MACHO PARALELA

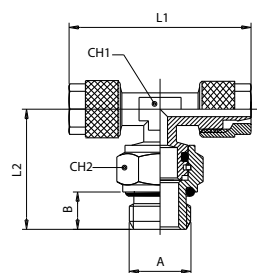

Code	Tube	A	B	L1	L2	CH1	CH2	Pack.
01215 00 001	6/4	1/8	5.4	41.2	22	8	13	10
01215 00 002	6/4	1/4	7.1	41.2	26	8	16	10
01215 00 003	8/6	1/8	5.4	43.2	24	9	13	10
01215 00 004	8/6	1/4	7.1	43.2	27.5	9	16	10
01215 00 006	10/8	1/8	5.4	48	22.5	11	13	10
01215 00 005	10/8	1/4	7.1	48	27.5	11	16	10

## 1220

### RACCORDO A T MASCHIO LATERALE CONICO

TEE MALE ADAPTOR (TAPER) - OFF SET LEG

L-EINSCHRAUBVERSCHRAUBUNG KONISCH (NICHT DREHBAR)

TÉ NON ORIENTABLE À PIQUAGE LATÉRAL, CONIQUE

RACOR A T MACHO LATERAL CÓNICO

CONEXÃO EM "T" LATERAL COM ROSCA MACHO CÔNICA

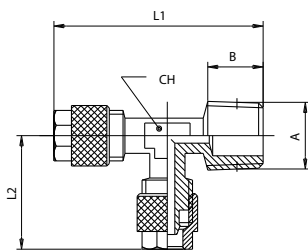

Code	Tube	A	B	L1	L2	CH	Pack.
01220 00 001	5/3	1/8	7.5	36.7	20.6	8	10
01220 00 002	6/4	1/8	7.5	36.7	20.6	8	10
01220 00 003	6/4	1/4	11	40.2	20.6	8	10
01220 00 004	8/6	1/8	7.5	38	21.9	9	10
01220 00 005	8/6	1/4	11	41.5	21.9	9	10
01220 00 006	10/8	1/8	7.5	40	25.5	11	10
01220 00 007	10/8	1/4	11	43	25.5	11	10
01220 00 008	10/8	3/8	11.5	44	25.5	11	10
01220 00 009	12/10	3/8	11.5	48.5	28	13	10
01220 00 010	15/12.5	1/2	14	57.5	32.5	16	10

## 1230

### RACCORDO A T INTERMEDIO

TEE CONNECTOR  
T-ANSCHLUSS  
RACCORD TÉ  
RACOR A T INTERMEDIO  
CONEXÃO EM "T" TUBO-TUBO

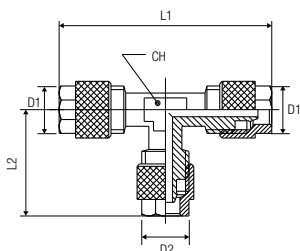

Code	D1	D2	L1	L2	CH	Pack.
01230 00 001	4/2.7	4/2.7	40	20.5	8	10
01230 00 002	5/3	5/3	41.2	20.6	8	10
01230 00 003	6/4	6/4	41.2	20.6	8	10
01230 00 004	8/6	6/4	43.8	20.6	9	10
01230 00 005	8/6	8/6	43.8	21.9	9	10
01230 00 006	10/8	6/4	51	20.6	11	10
01230 00 007	10/8	8/6	51	21.9	11	10
01230 00 008	10/8	10/8	51	25.5	11	10
01230 00 009	12/10	12/10	54	28	13	10
01230 00 010	15/12.5	15/12.5	63	32.5	16	10

## 1300

### RACCORDO A CROCE INTERMEDIO

EQUAL CROSS CONNECTOR  
KREUZ-ANSCHLUSS  
CROIX ÉGALE  
RACOR A CRUZ INTERMEDIO  
CONEXÃO CRUZETA TUBO-TUBO

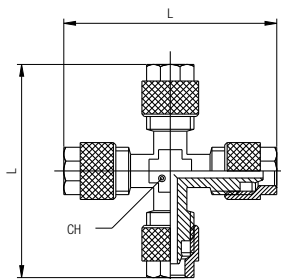

Code	Tube	L	CH	Pack.
01300 00 001	5/3	41.6	8	10
01300 00 002	6/4	41.6	8	10
01300 00 003	8/6	44.4	9	10
01300 00 004	10/8	49	11	10
01300 00 005	12/10	58	13	10
01300 00 006	15/12.5	64	17	10

## 51410

### VITE CAVA SINGOLA

BANJO SCREW SINGLE  
EINFACHE HOHLSCHRAUBE  
VIS POUR BANJO SIMPLE  
TORNILLO SIMPLE  
HASTE PARA CONEXÃO BANJO COM 1 CAVIDADE

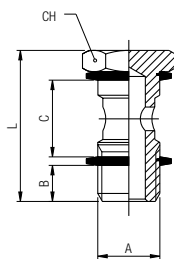

Code	A	B	C	L	CH	Pack.
51410 00 011	M5	4	12.5	22	8	10
51410 00 012	M6	5	12.5	23	8	10
51410 00 013	1/8	6	15	28	14	10
51410 00 014	1/4	8	17	32	17	10
51410 00 015	3/8	9	20	36	19	10
51410 00 016	1/2	10	24	42	24	10
* 51410 00 017	M12x1.5	8	17	32	17	10

Questo articolo viene fornito completo di rondelle in PA66 (art. 1610).

This item will be supplied with the PA66 washers (art. 1610).

Dieser artikel wird mit dichtungen aus PA66 (art. 1610) Mitgeliefert.

Livré avec joints en PA66 (art. 1610).

Este artículo viene completo de arandelas en nylon (art.1610).

Este item vem acompanhado de arruelas em PA66 (cód. 1610).

\* Con questa vite utilizzare gli anelli orientabili da 1/4.

\* With this banjo SCREW using 1/4 orienting banjo body.

\* Bei dieser größe können dichtringe für 1/4 eingesetzt werden.

\* Compatible avec joint 1/4".

\* Con este tornillo utilizar el anillo orientable de 1/4.

\* Com esta haste para banjo utilizar os anéis orientáveis de 1/4.

## 51420

### VITE CAVA DOPPIA

BANJO SCREW DOUBLE  
DOPPELTE HOHLSCHRAUBE  
VIS POUR BANJO DOUBLE  
TORNILLO DOBLE

HASTE PARA CONEXÃO BANJO COM 2 CAVIDADES

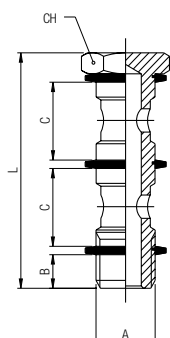

Code	A	B	C	L	CH	Pack.
51420 00 011	1/8	6	15	44.5	14	10
51420 00 012	1/4	8	17	50.5	17	10
51420 00 013	3/8	9	20	58	19	10
51420 00 014	1/2	10	24	68	24	10
51420 00 015	*M12x1.5	8	17	50.5	17	10

Questo articolo viene fornito completo di rondelle in PA66 (art. 1610).

This item will be supplied with the PA66 washers (art. 1610).

Dieser artikel wird mit dichtringen aus PA66 (art. 1610) Mitgeliefert.

Livré avec joints en PA66 (art. 1610).

Este artículo viene completo de arandelas en nylon (art.1610).

Este item vem acompanhado de arruelas em PA66 (cód. 1610).

\* Con questa vite utilizzare gli anelli orientabili da 1/4.

\* With this banjo SCREW using 1/4 orienting banjo body.

\* Bei dieser größe können dichtringe für 1/4 eingesetzt werden.

\* Compatible avec joint 1/4".

\* Con este tornillo utilizar el anillo orientable de 1/4.

\* Com esta haste para banjo utilizar os anéis orientáveis de 1/4.

## 51430

### VITE CAVA TRIPLA

BANJO SCREW TRIPLE  
DREIFACH HOHLSCHRAUBE  
VIS POUR BANJO TRIPLE  
TORNILLO TRIPLE

HASTE PARA CONEXÃO BANJO COM 3 CAVIDADES

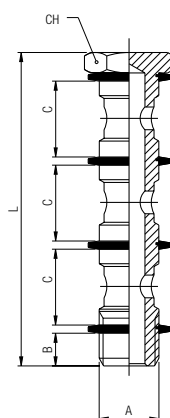

Code	A	B	C	L	CH	Pack.
51430 00 011	1/8	6	15	61	14	10
51430 00 012	1/4	8	17	69	17	10
51430 00 013	3/8	9	20	80	19	10
51430 00 014	1/2	10	24	94	24	10

Questo articolo viene fornito completo di rondelle in PA66 (art. 1610).

This item will be supplied with the PA66 washers (art. 1610).

Dieser artikel wird mit dichtringen aus PA66 (art. 1610) Mitgeliefert.

Livré avec joints en PA66 (art. 1610).

Este artículo viene completo de arandelas en nylon (art.1610).

Este item vem acompanhado de arruelas em PA66 (cód. 1610).

## 51440

### VITE CAVA SINGOLA MASCHIO - FEMMINA

MALE - FEMALE BANJO SCREW SINGLE  
AUFSCHRAUBHOHLSCHRAUBE MIT INNENGEWINDE  
VIS CREUSE TARAUDÉE POUR BANJO SIMPLE  
TORNILLO SIMPLE MACHO - HEMBRA

HASTE PARA CONEXÃO BANJO COM 1 CAVIDADE MACHO - FÊMEA

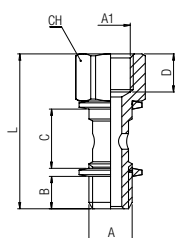

Code	A	A1	B	C	D	L	CH	Pack.
51440 00 001	1/8	1/8	6	15	8.5	34.5	14	10
51440 00 002	1/4	1/4	8	17	11	40.5	17	10
51440 00 003	3/8	3/8	9	20	12	45.5	19	10

Questo articolo viene fornito completo di rondelle in PA66 (art. 1610).

This item will be supplied with the PA66 washers (art. 1610).

Dieser artikel wird mit dichtringen aus PA66 (art. 1610) Mitgeliefert.

Livré avec joints en PA66 (art. 1610).

Este artículo viene completo de arandelas en nylon PA66 (art.1610).

Este item vem acompanhado de arruelas em PA66 (cód. 1610).

**1500**

**ANELLO ORIENTABILE A L**

SINGLE BANJO BODY  
RINGANSCHLUSS  
CORPS SIMPLE POUR BANJO  
ANILLO ORIENTABLE SIMPLE  
ANEL ORIENTÁVEL EM "L"

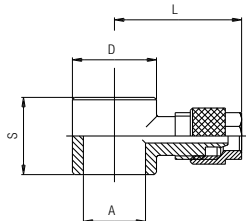

Code	Tube	A	D	S	L	Pack.
01500 00 001	4/2.7	M5	9	12.5	21.5	10
01500 00 002	4/2.7	M6	9	12.5	21.5	10
01500 00 003	4/2.7	1/8	14	15	22.5	10
01500 00 004	5/3	M5	9	12.5	22	10
01500 00 005	5/3	1/8	14	15	22.5	10
01500 00 006	6/4	M5	9	12.5	22	10
01500 00 007	6/4	M6	9	12.5	22	10
01500 00 008	6/4	1/8	14	15	23	10
01500 00 009	6/4	1/4	18	17	25	10
01500 00 010	6/4	3/8	21	20	27	10
01500 00 011	8/6	1/8	14	15	24.5	10
01500 00 012	8/6	1/4	18	17	26	10
01500 00 013	8/6	3/8	21	20	27	10
01500 00 014	8/6	1/2	26	24	31	10
01500 00 015	10/8	1/8	14	15	27.5	10
01500 00 016	10/8	1/4	18	17	27.5	10
01500 00 017	10/8	3/8	21	20	30.5	10
01500 00 018	10/8	1/2	26	24	34	10
01500 00 019	12/10	3/8	21	20	31.5	10
01500 00 020	12/10	1/2	26	24	35	10
01500 00 021	15/12.5	1/2	26	24	36.5	10

**1510**

**ANELLO ORIENTABILE A T**

DOUBLE BANJO BODY  
DOPPELTER RINGANSCHLUSS  
CORPS DOUBLE POUR BANJO  
ANILLO ORIENTABLE DOBLE  
ANEL ORIENTÁVEL EM "T"

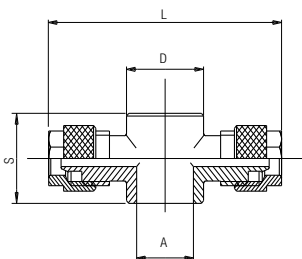

Code	Tube	A	D	S	L	Pack.
01510 00 001	4/2.7	M5	9	12.5	43	10
01510 00 002	4/2.7	1/8	14	15	43	10
01510 00 003	5/3	M5	9	12.5	43	10
01510 00 004	5/3	1/8	14	15	46.6	10
01510 00 005	6/4	M5	9	12.5	43	10
01510 00 006	6/4	1/8	14	15	46.6	10
01510 00 007	6/4	1/4	18	17	50.6	10
01510 00 008	6/4	3/8	21	20	53.6	10
01510 00 009	8/6	1/8	14	15	49.4	10
01510 00 010	8/6	1/4	18	17	55.2	10
01510 00 011	8/6	3/8	21	20	55	10
01510 00 012	8/6	1/2	26	24	61	10
01510 00 013	10/8	1/8	14	15	53	10
01510 00 014	10/8	1/4	18	17	59	10
01510 00 015	10/8	3/8	21	20	61	10
01510 00 016	10/8	1/2	26	24	66	10
01510 00 017	12/10	3/8	21	20	63	10
01510 00 018	12/10	1/2	26	24	70	10
01510 00 019	15/12.5	1/2	26	24	73	10

**LG 410**

**VITE CAVA SINGOLA SERIE LEGGERA**

BANJO SCREW SINGLE LIGHT  
EINFACHE HOHLSCHRAUBE LEICHTE SERIE  
VIS POUR BANJO SIMPLE - SÉRIE LÉGÈRE  
TORNILLO SIMPLE SERIE LIGERA  
HASTE PARA CONEXÃO BANJO COM 1 CAVIDADE SÉRIE LEVE

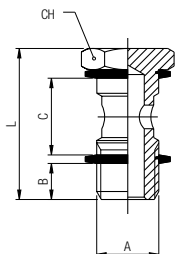

Code	A	B	C	L	CH	Pack.
LG410 00 002	M5	3.5	9	18	8	10
LG410 00 003	M6	4	9	19	8	10

Questo articolo viene fornito completo di rondelle in PA66 (art. 1610).  
This item will be supplied with the PA66 washers (art. 1610).  
Dieser artikel wird mit dichtungen aus PA66 (art. 1610) Mitgeliefert.  
Livré avec joints en PA66 (art. 1610).  
Este artículo viene completo de arandelas en nylon PA66 (art. 1610).  
Este item vem acompanhado de aruelas em PA66 (cód. 1610).



## LG 500

**ANELLO ORIENTABILE SERIE LEGGERA**  
 SINGLE BANJO BODY LIGHT  
 RINGANSCHLUSS LEICHTE SERIE  
 CORPS SIMPLE POUR BANJO - SÉRIE LÉGÈRE  
 ANILLO ORIENTABLE SIMPLE SERIE LIGERA  
 ANEL ORIENTÁVEL SÉRIE LEVE

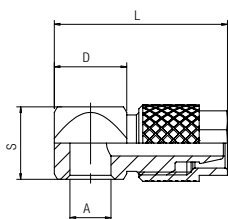

Code	Tube	A	D	S	L	Pack.
LG500 00 003	4/2.7	M5	9	9	21	10
LG500 00 005	4/2.7	M6	9	9	21	10
LG500 00 004	5/3	M5	9	9	21	10
LG500 00 002	6/4	M5	9	9	21	10
LG500 00 006	6/4	M6	9	9	21	10

## 1600

**RONDELLA IN ALLUMINIO**  
 ALUMINIUM WASHER  
 DICHTSCHEIBE AUS ALUMINIUM  
 JOINT EN ALUMINIUM  
 ARANDELA EN ALUMINIO  
 ARRUELA DE ALUMÍNIO

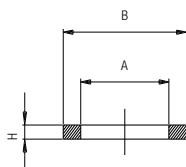

Code	Size	A	B	H	Pack.
01600 00 11 B5 00	M5	5.2	8	1	20
01600 00 11 02 00	1/8	10	14	1.5	20
01600 00 11 D7 00	M12	12.5	18	1.5	20
01600 00 11 03 00	1/4	13.5	18	1.5	20
01600 00 11 04 00	3/8	16.8	21	1.5	20
01600 00 11 05 00	1/2	21.1	26	1.5	20
01600 00 11 07 00	3/4	27.3	32	2.5	20
01600 00 11 09 00	1"	33.7	39.5	2.5	20

## 1610

**RONDELLA DENTELLATA IN PA66**  
 PA66 NOTCHED-WASHER  
 UNVERLIERBARE DICHTSCHEIBE AUS PA66  
 JOINT IMPERDABLE EN PA66  
 ARANDELA DENTADA EN NYLON PA66  
 ARRUELA DENTADA DE PA66

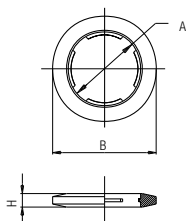

Code	Size	A	B	H	Pack.
01610 00 25 A7 00	M3	2.5	5.5	0.5	20
01610 00 25 B5 00	M5	5.1	8	1.3	20
01610 00 25 B8 00	M6	6.1	9	1.3	20
01610 00 25 02 00	1/8	9.8	14	1.8	20
01610 00 25 03 00	1/4	13.2	18	1.8	20
01610 00 25 04 00	3/8	16.6	21.9	1.6	20
01610 00 25 05 00	1/2	21	26	1.8	20
01610 00 25 07 00	3/4	26.5	33	2.5	20
01610 00 25 09 00	1"	33.3	41	2.5	20

	min	max
Temperature	- 20 °C	+ 90 °C

## 1612

**RONDELLA BIMATERIALE IN ACCIAIO E NBR**  
 STEEL AND NBR BIMATERIAL WASHER  
 BI-MATERIAL STAHL SCHEIBE UND NBR  
 JOINT BI-MATIÈRE - ACIER/NBR  
 ARANDELA BIMATERIAL EN ACERO Y NBR  
 ARRUELA BI-MATERIAL EM AÇO E NBR

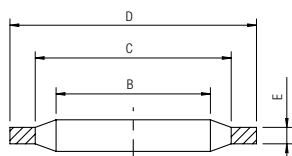

Code	Size	B	C	D	E	Pack.
01612 00 001	1/8	10.4	12	14.7	1.25	20
01612 00 002	1/4	13.85	15.75	18.7	1.25	20
01612 00 003	3/8	17.35	19.25	22.7	1.25	20
01612 00 004	1/2	21.65	23.55	26.7	1.25	20
01612 00 005	3/4	27.3	29.2	32.5	1.25	20
01612 00 006	1"	34.2	36.1	39.5	2	20

	min	max
Temperature	- 30 °C	+ 100 °C

## 1613

### RONDELLA AUTOCENTRANTE BIMATERIALE IN ACCIAIO E NBR

STEEL AND NBR CENTERING BIMATERIAL WASHER  
 BI-MATERIAL STAHL SCHEIBE UND NBR  
 JOINT BI-MATIÈRE - ACIER/NBR  
 ARANDELA BIMATERIAL EN ACERO Y NBR  
 ARRUELA BI-MATERIAL EM AÇO E NBR

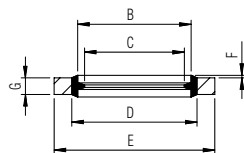

Code	Size	B	C	D	E	G	F	Pack.
01613 00 001	1/8	10.4	8.6	11.85	14	2	0.3	20
01613 00 002	1/4	13.75	11.45	15.2	17	2	0.3	20
01613 00 003	3/8	17.3	15	18.75	22	2	0.3	20
01613 00 004	1/2	21.55	18.65	23	26	2.5	0.4	20
01613 00 005	3/4	27.05	24.15	28.5	32	2.5	0.4	20
01613 00 006	1"	33.9	30.30	36.9	41	3.2	0.5	20

	min	max
Temperature	- 40 °C	+ 100 °C

## 1700

### DADO DI BLOCCAGGIO

LOCKING NUT  
 ÜBERWURFMUTTER  
 ÉCROU  
 TUERCA DE BLOCAJE  
 PORCA DE TRAVAMENTO

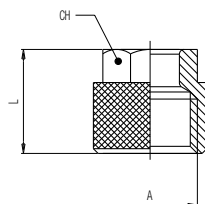

Code	Tube	A	L	CH	Pack.
01700 00 01 3Z NB	4/2.7	M6x0.5	9	7	50
01700 00 01 6Z NB	5/3	M7x0.75	11	8	50
01700 00 01 9Z NB	6/4	M8x0.75	11	8	50
01700 00 01 0X NB	6/4	M10x1	11	10	50
01700 00 01 4X NB	8/6	M12x1	11.5	12	50
01700 00 01 5X NB	10/8	M14x1	13.5	14	50
01700 00 01 6X NB	12/10	M16x1	15	15	50
01700 00 01 7X NB	15/12.5	M20x1	16	19	50

## 1710

### DADO DI BLOCCAGGIO OTTONE CON MOLLA INOX

BRASS LOCKING NUT WITH STAINLESS STEEL SPRING  
 MESSING ÜBERWURFMUTTER MIT KNICKSCHUTZFEDER EDELSTAHL  
 ÉCROU LAITON AVEC RESSORT DE PROTECTION ACIER INOXYDABLE  
 TUERCA DE BLOCAJE LATÃO COM MUELLE ACERO INOXIDABLE  
 PORCA DE TRAVAMENTO LATÃO COM MOLA AÇO INOXIDÁVEL

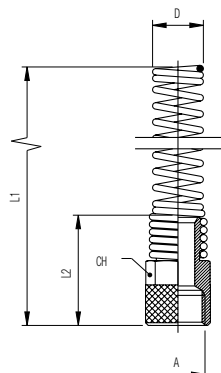

Code	Tube	A	D	L1	L2	CH	Pack.
01710 00 001	6/4	M10x1	9.4	93	20	11	20
01710 00 002	8/6	M12x1	11.4	98.5	21	13	20
01710 00 003	10/8	M14x1	13.4	107	24	14	20
01710 00 004	12/10	M16x1	16	116.5	27.5	17	20

Molla Acciaio Inox AISI 304 - EN 1.4301  
 Stainless Steel Spring AISI 304 - EN 1.4301  
 Edelstahlfeder AISI 304 - EN 1.4301  
 Ressort Acier Inoxydable AISI 304 - EN 1.4301  
 Muelle Acero Inoxidable AISI 304 - EN 1.4301  
 Mola Aço Inoxidável AISI 304 - EN 1.4301

## 1750

### TAGLIATUBO IN TECNOPOLIMERO

TECHNOPOLYMER PIPE CUTTER  
 ROHRSCHEIDER KUNSTSTOFF  
 COUPE TUBE POUR TUBE PLASTIQUE  
 CORTATUBOS EN PLÁSTICO  
 CORTADOR DE TUBO EM PLÁSTICO

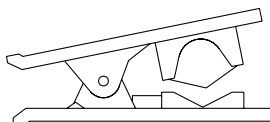

Code	Pack.
01750 00 001	10

## 8610

### TAPPO IN POLIAMIDE

POLYAMIDE PLUG  
 VERSCHLUSSZAPFEN POLYAMID  
 BOUCHON EN POLYAMIDE  
 TAPÓN EN POLIAMIDA  
 TAMPÃO EM POLIAMIDA

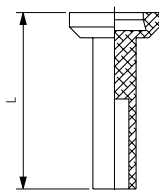

Code	Tube	L	Pack.
08610 00 31 X1 RO	4	23.5	10
08610 00 31 X3 RO	5	24.5	10
08610 00 31 X4 RO	6	24.5	10
08610 00 31 X7 RO	8	26	10
08610 00 31 X9 RO	10	28.5	10
08610 00 31 Y1 RO	12	28.5	10

