











































50N Series

 50000N Pg. 4.5	 50010N Pg. 4.5	 50110N Pg. 4.5	 50120N Pg. 4.5	 50210N Pg. 4.6	 50222N Pg. 4.6	 50010N Pg. 4.6	 50020N Pg. 4.7	 50030N Pg. 4.7
 50105N Pg. 4.8	 50115N Pg. 4.8	 50125N Pg. 4.8	 50215N Pg. 4.9	 50225N Pg. 4.9	 50326N Pg. 4.9	 50100N Pg. 4.10	 50200N Pg. 4.10	 50040N Pg. 4.10
 50050N Pg. 4.10	 50055N Pg. 4.10	 50465N Pg. 4.11	 50130N Pg. 4.11	 50310N Pg. 4.11	 50230N Pg. 4.11	 50500N Pg. 4.12	 50510N Pg. 4.12	 50600 Pg. 4.12
 50610 Pg. 4.13	 50625 Pg. 4.13	 50700N Pg. 4.13	 50900N Pg. 4.13	 55800N Pg. 4.14	 55801 Pg. 4.14	 55802 Pg. 4.14	 50980 Pg. 4.15	 50991 Pg. 4.15
 50006 Pg. 4.15								

Fitting Kits

 50861N-4 Pg. 4.16	 50861N-6 Pg. 4.16	 50861N-8 Pg. 4.16	 50861N-10 Pg. 4.17
 50861N-12 Pg. 4.17			

PUSH-TO-CONNECT FITTINGS
FOR METRIC TUBE



50N Series

5000N



TECHNICAL CHARACTERISTICS



Reference Standard

1907/2006
REACH ✓

2011/65/CE
RoHS ✓

PED
2014/68/UE

ISO
14743:2004

SILICON
FREE

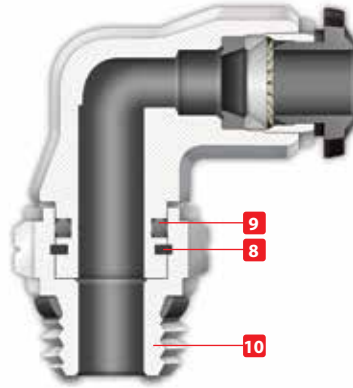
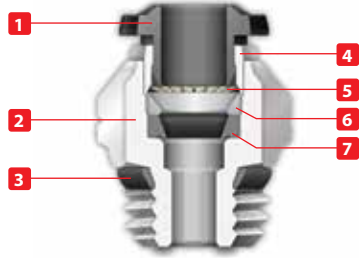

Pressure Rating

Vacuum ~ 290 PSI
-0.99 bar ~ 20 bar
-0.099 MPa ~ 2.0 MPa



Temperatures Rating

NBR
-4° F ~ 176° F
-20° C ~ 80° C



Media

- Compressed Air
- Vacuum
- Water
- Steam (FKM required)



Applications

- Pneumatic Automation
- Automotive
- Textile, Packaging
- Compressed Air Circuit
- Vacuum



Advantages

- 1 The 303 Stainless Steel gripper ensures a tight clamp for tubes of any material without damaging the tube's surface. The secure connection between the tube and the fitting will hold up to severe conditions such as impact and vibrations.
- 2 The shape of the safety ring and the molded seal perfectly seal off the tube, creating a vacuum.
- 3 Series with several types of threads:
SWIFFFIT
BSPP
BSPT
- 4 All straight fittings can be tightened with an Allen wrench because of our internal hex design. This enables the end user to tighten the fitting in spaces too small for an openend wrench.
- 5 Our rotating Swivel Elbow fittings are equipped with a safety ring that enables the fitting to rotate without losing a tight seal.



Component Parts and Materials

- 1 Composite Release Collet
- 2 Nickel Plated Brass Body
- 3 NBR Thread Seal
- 4 Nickel Plated Brass Sleeve
- 5 303 Stainless Steel Gripper
- 6 Technopolymer Safety Ring
- 7 NBR Molded Seal
- 8 Safety Ring
- 9 NBR Seal
- 10 Nickel Plated Thread Brass Body



Tubing Compatibility

- Nylon 6 - 11 -12
- Polyethylene
- Polyurethane ("98 Shore A for best result)
- PTFE
- FEP

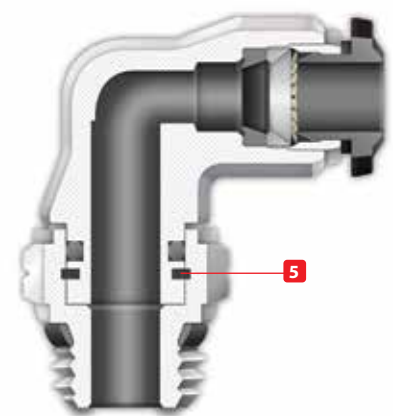
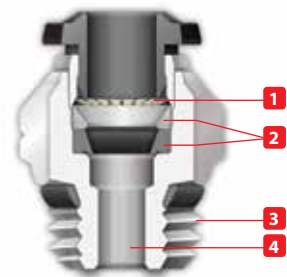



THREADS & ADVANTAGES



SWIFFFIT
Universal thread

One fitting... Endless possibilities

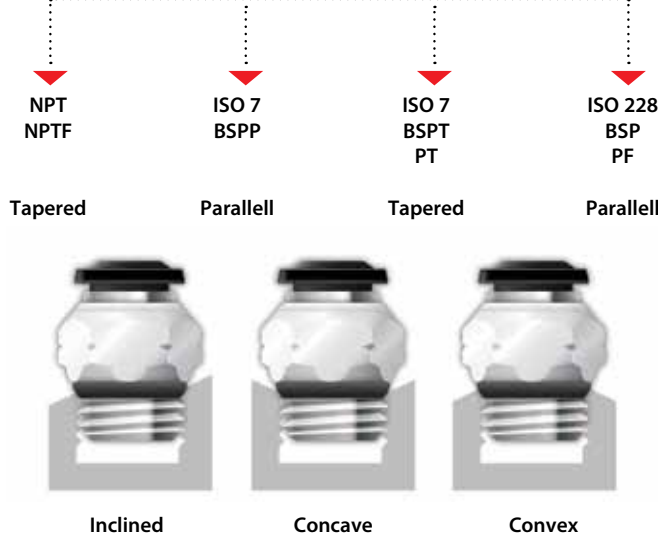

Our **SWIFFFIT** universal fittings also work on non-flat surfaces without compromising an air-tight seal.

The **SWIFFFIT** Universal Thread has been designed to offer the following advantages to the end users:

- Reduced overall length
- Smaller hex dimensions compared to parallel threads
- Fits with various parallel and tapered threads
- All **SWIFFFIT** fittings have been equipped with threads and an NBR thread seal that will universally connect to all thread types.

Torque Specifications

Recommended Torque		
Thread Size	Min.	Max.
1/8	5 Nm	7 Nm
1/4	5 Nm	7 Nm
3/8	5 Nm	7 Nm
1/2	5 Nm	7 Nm



BSPP Threads



The **BSPP** Thread has been designed to offer the following advantages to the end users:

- Standard ISO 228 and ISO R/262
- Designed for use in BSPP connections with an integrated NBR o-ring that provides a perfect seal
- Completely reusable

Torque Specifications

Recommended Torque		
Thread Size	Min.	Breaking torque
M5	0.8 Nm	3.2 Nm
M7	3 Nm	8 Nm
M8	3 Nm	8 Nm
1/2	3 Nm	8 Nm
1/4	9 Nm	30 Nm
3/8	10 Nm	60 Nm
1/2	12 Nm	50 Nm



BSPT Thread with seal



The **BSPT** Thread has been designed to offer the following advantages to the end users:

- Standard ISO 7.1, BS 21, DN 2999
- Designed for use in BSPT and BSPP connections with an integrated NBR thread seal that provides an additional seal

Torque Specifications

Recommended Torque		
Thread Size	Min.	Max.
1/8	5 Nm	7 Nm
1/4	5 Nm	7 Nm
3/8	5 Nm	7 Nm
1/2	5 Nm	7 Nm

50000N

STRAIGHT MALE

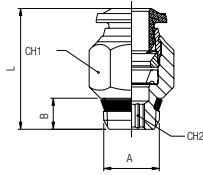

Part No.	Tube	A	B	L	CH1	CH2
50000N-4-1/8	5/32 (4)	1/8	.217 (5,5)	.709 (18)	.433 (11)	.118 (3)
50000N-4-1/4	5/32 (4)	1/4	.276 (7)	.748 (19)	.551 (14)	.118 (3)
50000N-5-1/8	5	1/8	.217 (5,5)	.787 (20)	.433 (11)	.157 (4)
50000N-5-1/4	5	1/4	.276 (7)	.787 (20)	.551 (14)	.157 (4)
50000N-6-1/8	6	1/8	.217 (5,5)	.846 (21,5)	.512 (13)	.157 (4)
50000N-6-1/4	6	1/4	.276 (7)	.827 (21)	.551 (14)	.157 (4)
50000N-6-3/8	6	3/8	.295 (7,5)	.906 (23)	.669 (17)	.157 (4)
50000N-6-1/2	6	1/2	.354 (9)	.925 (23,5)	.827 (21)	.157 (4)
50000N-8-1/8	5/16 (8)	1/8	.217 (5,5)	.965 (24,5)	.551 (14)	.197 (5)
50000N-8-1/4	5/16 (8)	1/4	.276 (7)	.866 (22)	.551 (14)	.236 (6)
50000N-8-3/8	5/16 (8)	3/8	.295 (7,5)	.906 (23)	.669 (17)	.236 (6)
50000N-8-1/2	5/16 (8)	1/2	.354 (9)	.925 (23,5)	.827 (21)	.236 (6)
50000N-10-1/4	10	1/4	.276 (7)	1.102 (28)	.669 (17)	.276 (7)
50000N-10-3/8	10	3/8	.295 (7,5)	1.004 (25,5)	.669 (17)	.315 (8)
50000N-10-1/2	10	1/2	.354 (9)	1.024 (26)	.827 (21)	.315 (8)
50000N-12-1/4	12	1/4	.276 (7)	1.240 (31,5)	.787 (20)	.276 (7)
50000N-12-3/8	12	3/8	.295 (7,5)	1.161 (29,5)	.787 (20)	.354 (9)
50000N-12-1/2	12	1/2	.354 (9)	1.240 (31,5)	.827 (21)	.394 (10)
50000N-14-3/8	14	3/8	.295 (7,5)	1.280 (32,5)	.827 (21)	.354 (9)
50000N-14-1/2	14	1/2	.354 (9)	1.240 (31,5)	.827 (21)	.394 (10)
50000N-16-3/8	16	3/8	.295 (7,5)	1.378 (35)	.905 (23)	.394 (10)
50000N-16-1/2	16	1/2	.354 (9)	1.378 (35)	.984 (25)	.472 (12)

50010N

STRAIGHT MALE WITH INTERNAL HEX

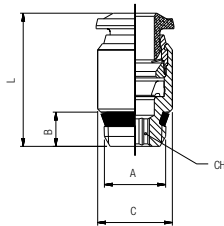

Part No.	Tube	A	B	C	L	CH
50010N-4-1/8	5/32 (4)	1/8	.217 (5,5)	.433 (11)	.709 (18)	.118 (3)
50010N-6-1/8	6	1/8	.217 (5,5)	.472 (12)	.867 (21,5)	.157 (4)
50010N-6-1/4	6	1/4	.276 (7)	.551 (14)	.827 (21)	.157 (4)
50010N-8-1/8	5/16 (8)	1/8	.217 (5,5)	.551 (14)	.984 (25)	.196 (5)
50010N-8-1/4	5/16 (8)	1/4	.276 (7)	.551 (14)	.886 (22,5)	.236 (6)

50110N

SWIVEL ELBOW

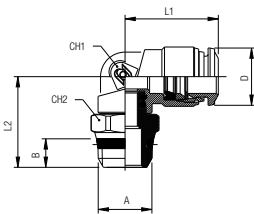

Part No.	Tube	A	B	L1	L2	CH1	CH2	D
50110N-4-1/8	5/32 (4)	1/8	.216 (5,5)	.708 (18)	.767 (19,5)	.354 (9)	.512 (13)	.394 (10)
50110N-4-1/4	5/32 (4)	1/4	.275 (7)	.748 (19)	.826 (21)	.354 (9)	.590 (15)	.394 (10)
50110N-5-1/8	5	1/8	.216 (5,5)	.788 (20)	.846 (21,5)	.433 (11)	.512 (13)	.492 (12,5)
50110N-6-1/8	6	1/8	.216 (5,5)	.826 (21)	.846 (21,5)	.433 (11)	.512 (13)	.492 (12,5)
50110N-6-1/4	6	1/4	.275 (7)	.826 (21)	.905 (23)	.433 (11)	.590 (15)	.492 (12,5)
50110N-8-1/8	5/16 (8)	1/8	.216 (5,5)	.885 (22,5)	.885 (22,5)	.472 (12)	.512 (13)	.571 (14,5)
50110N-8-1/4	5/16 (8)	1/4	.275 (7)	.885 (22,5)	.885 (22,5)	.472 (12)	.590 (15)	.571 (14,5)
50110N-8-3/8	5/16 (8)	3/8	.295 (7,5)	.885 (22,5)	.905 (23)	.472 (12)	.669 (17)	.571 (14,5)
50110N-8-1/2	5/16 (8)	1/2	.354 (9)	.885 (22,5)	1.003 (25,5)	.472 (12)	.826 (21)	.571 (14,5)
50110N-10-1/4	10	1/4	.275 (7)	1.043 (26,5)	1.043 (26,5)	.551 (14)	.629 (16)	.689 (17,5)
50110N-10-3/8	10	3/8	.295 (7,5)	1.043 (26,5)	.946 (24,5)	.551 (14)	.669 (17)	.689 (17,5)
50110N-10-1/2	10	1/2	.354 (9)	1.043 (26,5)	1.062 (27)	.551 (14)	.826 (21)	.689 (17,5)
50110N-12-3/8	12	3/8	.295 (7,5)	1.240 (31,5)	1.043 (26,5)	.629 (16)	.787 (20)	.846 (21,5)
50110N-12-1/2	12	1/2	.354 (9)	1.240 (31,5)	1.141 (29)	.629 (16)	.826 (21)	.846 (21,5)
50110N-14-3/8	14	3/8	.295 (7,5)	1.240 (31,5)	1.062 (27)	.629 (16)	.787 (20)	.846 (21,5)
50110N-14-1/2	14	1/2	.354 (9)	1.240 (31,5)	1.161 (29,5)	.629 (16)	.826 (21)	.846 (21,5)
50110N-16-3/8	16	3/8	.295 (7,5)	1.299 (33)	1.634 (41,5)	.748 (19)	.984 (25)	.925 (23,5)
50110N-16-1/2	16	1/2	.354 (9)	1.299 (33)	1.693 (43)	.748 (19)	.984 (25)	.925 (23,5)

50120N

SWIVEL MALE EXTENDED ELBOW

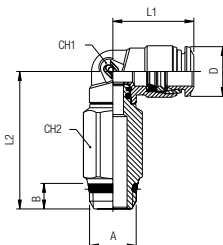

Part No.	Tube	A	B	L1	L2	CH1	CH2	D
50120N-4-1/8	5/32 (4)	1/8	.217 (5,5)	.709 (18)	1.240 (31,5)	.354 (9)	.472 (12)	.394 (10)
50120N-4-1/4	5/32 (4)	1/4	.276 (7)	.709 (18)	1.299 (33)	.354 (9)	.591 (15)	.394 (10)
50120N-5-1/8	5	1/8	.217 (5,5)	.787 (20)	1.417 (36)	.433 (11)	.472 (12)	.492 (12,5)
50120N-6-1/8	6	1/8	.217 (5,5)	.827 (21)	1.417 (36)	.433 (11)	.472 (12)	.492 (12,5)
50120N-6-1/4	6	1/4	.276 (7)	.827 (21)	1.476 (37,5)	.433 (11)	.591 (15)	.492 (12,5)
50120N-8-1/8	5/16 (8)	1/8	.197 (5)	.898 (22,5)	1.595 (40,5)	.472 (12)	.472 (12)	.571 (14,5)
50120N-8-1/4	5/16 (8)	1/4	.276 (7)	.886 (22,5)	1.595 (40,5)	.472 (12)	.591 (15)	.571 (14,5)
50120N-8-3/8	5/16 (8)	3/8	.296 (7,5)	.886 (22,5)	1.614 (41)	.472 (12)	.630 (16)	.571 (14,5)
50120N-10-1/4	10	1/4	.276 (7)	1.043 (26,5)	1.811 (46)	.551 (14)	.591 (15)	.689 (17,5)
50120N-10-3/8	10	3/8	.296 (7,5)	1.043 (26,5)	1.733 (44)	.551 (14)	.670 (17)	.689 (17,5)

50210N

SWIVEL BRANCH TEE

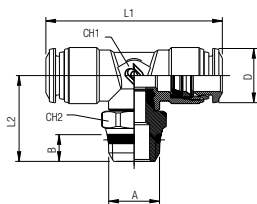

Part No.	Tube	A	B	L1	L2	CH1	CH2	D
50210N-4-1/8	5/32 (4)	1/8	.216 (5,5)	1.338 (34)	.787 (20)	.354 (9)	.511 (13)	.394 (10)
50210N-4-1/4	5/32 (4)	1/4	.275 (7)	1.338 (34)	.846 (21,5)	.354 (9)	.590 (15)	.394 (10)
50210N-5-1/8	5	1/8	.216 (5,5)	1.575 (40)	.866 (22)	.433 (11)	.511 (13)	.492 (12,5)
50210N-6-1/8	6	1/8	.216 (5,5)	1.653 (42)	.866 (22)	.433 (11)	.511 (13)	.492 (12,5)
50210N-6-1/4	6	1/4	.275 (7)	1.653 (42)	.925 (23,5)	.433 (11)	.590 (15)	.492 (12,5)
50210N-8-1/8	5/16 (8)	1/8	.216 (5,5)	1.771 (45)	1.003 (25,5)	.511 (13)	.511 (13)	.571 (14,5)
50210N-8-1/4	5/16 (8)	1/4	.275 (7)	1.771 (45)	1.003 (25,5)	.511 (13)	.590 (15)	.571 (14,5)
50210N-8-3/8	5/16 (8)	3/8	.295 (7,5)	1.771 (45)	1.023 (26)	.511 (13)	.669 (17)	.571 (14,5)
50210N-8-1/2	5/16 (8)	1/2	.354 (9)	1.771 (45)	1.122 (28,5)	.511 (13)	.826 (21)	.571 (14,5)
50210N-10-1/4	10	1/4	.275 (7)	2.086 (53)	1.141 (29)	.551 (14)	.629 (16)	.689 (17,5)
50210N-10-3/8	10	3/8	.295 (7,5)	2.086 (53)	1.062 (27)	.551 (14)	.669 (17)	.689 (17,5)
50210N-10-1/2	10	1/2	.354 (9)	2.086 (53)	1.161 (29,5)	.551 (14)	.826 (21)	.689 (17,5)
50210N-12-3/8	12	3/8	.295 (7,5)	2.460 (62,5)	1.161 (29,5)	.629 (16)	.787 (20)	.846 (21,5)
50210N-12-1/2	12	1/2	.354 (9)	2.460 (62,5)	1.259 (32)	.629 (16)	.826 (21)	.846 (21,5)
50210N-14-3/8	14	3/8	.295 (7,5)	2.460 (62,5)	1.161 (29,5)	.629 (16)	.787 (20)	.846 (21,5)
50210N-14-1/2	14	1/2	.354 (9)	2.460 (62,5)	1.259 (32)	.629 (16)	.826 (21)	.846 (21,5)
50210N-16-3/8	16	3/8	.295 (7,5)	2.578 (65,5)	1.575 (40)	.748 (19)	.984 (25)	.925 (23,5)
50210N-16-1/2	16	1/2	.354 (9)	2.578 (65,5)	1.634 (41,5)	.748 (19)	.984 (25)	.925 (23,5)

50222N

SWIVEL RUN TEE

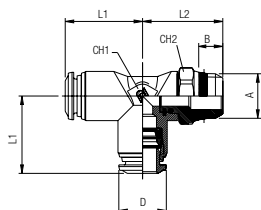

Part No.	Tube	A	B	L1	L2	CH1	CH2	D
50222N-4-1/8	5/32 (4)	1/8	.216 (5,5)	.669 (17)	.787 (20)	.354 (9)	.511 (13)	.394 (10)
50222N-4-1/4	5/32 (4)	1/4	.275 (7)	.669 (17)	.846 (21,5)	.354 (9)	.590 (15)	.394 (10)
50222N-5-1/8	5	1/8	.216 (5,5)	.788 (20)	.866 (22)	.433 (11)	.511 (13)	.492 (12,5)
50222N-6-1/8	6	1/8	.216 (5,5)	.826 (21)	.866 (22)	.433 (11)	.511 (13)	.492 (12,5)
50222N-6-1/4	6	1/4	.275 (7)	.826 (21)	.925 (23,5)	.433 (11)	.590 (15)	.492 (12,5)
50222N-8-1/8	5/16 (8)	1/8	.216 (5,5)	.885 (22,5)	.944 (24)	.511 (13)	.511 (13)	.571 (14,5)
50222N-8-1/4	5/16 (8)	1/4	.275 (7)	.885 (22,5)	.944 (24)	.511 (13)	.590 (15)	.571 (14,5)
50222N-8-3/8	5/16 (8)	3/8	.295 (7,5)	.885 (22,5)	1.062 (27)	.511 (13)	.669 (17)	.571 (14,5)
50222N-8-1/2	5/16 (8)	1/2	.354 (9)	.885 (22,5)	1.062 (27)	.511 (13)	.826 (21)	.571 (14,5)
50222N-10-1/4	10	1/4	.275 (7)	1.043 (26,5)	1.023 (26)	.551 (14)	.629 (16)	.689 (17,5)
50222N-10-3/8	10	3/8	.295 (7,5)	1.043 (26,5)	1.023 (26)	.551 (14)	.669 (17)	.689 (17,5)
50222N-10-1/2	10	1/2	.354 (9)	1.043 (26,5)	1.122 (28,5)	.551 (14)	.826 (21)	.689 (17,5)
50222N-12-3/8	12	3/8	.295 (7,5)	1.240 (31,5)	1.161 (29,5)	.629 (16)	.787 (20)	.847 (21,5)
50222N-12-1/2	12	1/2	.354 (9)	1.240 (31,5)	1.259 (32)	.629 (16)	.826 (21)	.847 (21,5)

50010N

STRAIGHT MALE WITH INTERNAL HEX

BSPP

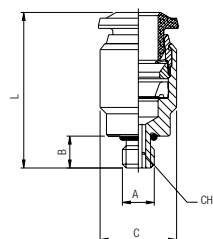

Part No.	Tube	A	B	C	L	CH
50010N-3-M5	3	M5	.141 (3,6)	.315 (8)	.748 (19)	.098 (2,5)
50010N-4-M5	5/32 (4)	M5	.141 (3,6)	.394 (10)	.768 (19,5)	.098 (2,5)
50010N-4-M7x1	5/32 (4)	M7x1	.188 (4,8)	.394 (10)	.827 (21)	.098 (2,5)
50010N-6-M5	6	M5	.141 (3,6)	.472 (12)	.965 (24,5)	.098 (2,5)
50010N-6-M6x1	6	M6x1	.141 (3,6)	.472 (12)	.944 (24)	.098 (2,5)

50020N

STRAIGHT MALE

BSPP

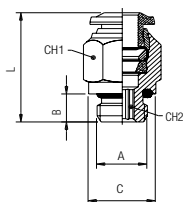

Part No.	Tube	A	B	C	L	CH1	CH2
50020N-3-M5	3	M5	.141 (3,6)	.315 (8)	.748 (19)	.315 (8)	.079 (2)
50020N-4-M3	5/32 (4)	M3	.118 (3)	.394 (10)	.827 (21)	-	.315 (8)
50020N-4-M5	5/32 (4)	M5	.141 (3,6)	.315 (8)	.827 (21)	.394 (10)	.079 (2)
50020N-4-1/8	5/32 (4)	1/8	.212 (5,4)	.512 (13)	.787 (20)	.394 (10)	.118 (3)
50020N-4-1/4	5/32 (4)	1/4	.279 (7,1)	.630 (16)	.768 (19,5)	.630 (16)	.118 (3)
50020N-4-3/8	5/32 (4)	3/8	.318 (8,1)	.787 (20)	.708 (18)	.787 (20)	.118 (3)
50020N-5-M5	5	M5	.141 (3,6)	.315 (8)	.925 (23,5)	.472 (12)	.079 (2)
50020N-5-1/8	5	1/8	.212 (5,4)	.512 (13)	.866 (22)	.472 (12)	.157 (4)
50020N-5-1/4	5	1/4	.279 (7,1)	.630 (16)	.866 (22)	.472 (12)	.157 (4)
50020N-6-M5	6	M5	.141 (3,6)	.394 (10)	.965 (24,5)	.512 (13)	.079 (2)
50020N-6-1/8	6	1/8	.212 (5,4)	.512 (13)	.925 (23,5)	.512 (13)	.157 (4)
50020N-6-1/4	6	1/4	.279 (7,1)	.630 (16)	.925 (23,5)	.512 (13)	.157 (4)
50020N-6-3/8	6	3/8	.318 (8,1)	.787 (20)	.984 (25)	.512 (13)	.157 (4)
50020N-6-1/2	6	1/2	.377 (9,6)	.984 (25)	1.063 (27)	.512 (13)	.157 (4)
50020N-8-1/8	5/16 (8)	1/8	.279 (7,1)	.512 (13)	.984 (25)	.551 (14)	.197 (5)
50020N-8-1/4	5/16 (8)	1/4	.318 (8,1)	.630 (16)	.906 (23)	.551 (14)	.236 (6)
50020N-8-3/8	5/16 (8)	3/8	.318 (8,1)	.787 (20)	.945 (24)	.551 (14)	.236 (6)
50020N-8-1/2	5/16 (8)	1/2	.377 (9,6)	.984 (25)	1.043 (26,5)	.551 (14)	.236 (6)
50020N-10-1/8	10	1/8	.216 (5,5)	.512 (13)	1.181 (30)	.669 (17)	.197 (5)
50020N-10-1/4	10	1/4	.279 (7,1)	.630 (16)	1.201 (30,5)	.669 (17)	.236 (6)
50020N-10-3/8	10	3/8	.318 (8,1)	.787 (20)	1.083 (27,5)	.669 (17)	.315 (8)
50020N-10-1/2	10	1/2	.377 (9,6)	.984 (25)	1.063 (27)	.669 (17)	.315 (8)
50020N-12-1/4	12	1/4	.279 (7,1)	.630 (16)	1.358 (34,5)	.787 (20)	.236 (6)
50020N-12-3/8	12	3/8	.318 (8,1)	.787 (20)	1.339 (34)	.787 (20)	.315 (8)
50020N-12-1/2	12	1/2	.377 (9,6)	.984 (25)	1.220 (31)	.866 (22)	.394 (10)
50020N-14-3/8	14	3/8	.318 (8,1)	.787 (20)	1.378 (35)	.827 (21)	.394 (10)
50020N-14-1/2	14	1/2	.377 (9,6)	.984 (25)	1.260 (32)	.866 (22)	.394 (10)
50020N-16-3/8	16	3/8	.318 (8,1)	.787 (20)	1.417 (36)	.905 (23)	.394 (10)
50020N-16-1/2	16	1/2	.377 (9,6)	.984 (25)	1.457 (37)	.984 (25)	.472 (12)
50020N-4-M6x1	4	M6x1	.216 (5,5)	.472 (12)	.728 (18,5)	.394 (10)	.118 (3)
50020N-4-M8x1	4	M8x1	.216 (5,5)	.472 (12)	.728 (18,5)	.394 (10)	.118 (3)
50020N-6-M8x1	6	M8x1	.212 (5,4)	.472 (12)	.965 (24,5)	.512 (13)	.118 (3)
50020N-6-M10x1	6	M10x1	.212 (5,4)	.512 (13)	.905 (23)	.512 (13)	.157 (4)
50020N-6-M12x1	6	M12x1	.287 (7,3)	.591 (15)	.925 (23,5)	.512 (13)	.157 (4)
50020N-6-M12x1,25	6	M12x1,25	.287 (7,3)	.591 (15)	.925 (23,5)	.512 (13)	.157 (4)
50020N-6-M12x1,5	6	M12x1,5	.287 (7,3)	.591 (15)	.925 (23,5)	.512 (13)	.157 (4)
50020N-8-M8x1	8	M8x1	.212 (5,4)	.472 (12)	1.004 (25,5)	.551 (14)	.157 (4)
50020N-8-M10x1	8	M10x1	.212 (5,4)	.512 (13)	1.004 (25,5)	.551 (14)	.157 (4)
50020N-8-M12x1,5	8	M12x1,5	.287 (7,3)	.591 (15)	1.083 (27,5)	.551 (14)	.236 (6)

50030N

STRAIGHT FEMALE

BSPP

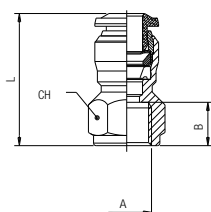

Part No.	Tube	A	B	L	CH
50030N-3-M5	3	M5	.216 (5,5)	.728 (18,5)	.355 (9)
50030N-4-M5	5/32 (4)	M5	.216 (5,5)	.826 (21)	.433 (11)
50030N-4-1/8	5/32 (4)	1/8	.334 (8,5)	.944 (24)	.511 (13)
50030N-4-1/4	5/32 (4)	1/4	.433 (11)	1.082 (27,5)	.629 (16)
50030N-5-1/8	5	1/8	.334 (8,5)	1.043 (26,5)	.511 (13)
50030N-6-1/8	6	1/8	.334 (8,5)	1.023 (26)	.511 (13)
50030N-6-1/4	6	1/4	.433 (11)	1.161 (29,5)	.629 (16)
50030N-8-1/8	5/16 (8)	1/8	.334 (8,5)	1.062 (27)	.590 (15)
50030N-8-1/4	5/16 (8)	1/4	.433 (11)	1.161 (29,5)	.669 (17)
50030N-8-3/8	5/16 (8)	3/8	.472 (12)	1.259 (32)	.748 (19)
50030N-10-1/4	10	1/4	.433 (11)	1.259 (32)	.708 (18)
50030N-10-3/8	10	3/8	.472 (12)	1.318 (33,5)	.748 (19)
50030N-10-1/2	10	1/2	.590 (15)	1.535 (39)	.944 (24)
50030N-12-3/8	12	3/8	.472 (12)	1.417 (36)	.826 (21)
50030N-12-1/2	12	1/2	.590 (15)	1.614 (41)	.944 (24)
50030N-16-3/8	16	3/8	.472 (12)	1.595 (40,5)	.944 (24)
50030N-16-1/2	16	1/2	.590 (15)	1.595 (40,5)	.944 (24)

50105N

FEMALE ELBOW

BSPP

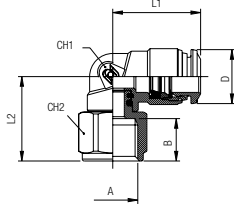

Part No.	Tube	A	B	L1	L2	CH1	CH2	D
50105N-4-1/8	5/32 (4)	1/8	.334 (8,5)	.708 (18)	.787 (20)	.354 (9)	.511 (13)	.394 (10)
50105N-4-1/4	5/32 (4)	1/4	.433 (11)	.708 (18)	.846 (21,5)	.354 (9)	.629 (16)	.394 (10)
50105N-6-1/8	6	1/8	.334 (8,5)	.826 (21)	.807 (20,5)	.433 (11)	.511 (13)	.492 (12,5)
50105N-6-1/4	6	1/4	.433 (11)	.826 (21)	.905 (23)	.433 (11)	.629 (16)	.492 (12,5)
50105N-8-1/8	5/16 (8)	1/8	.334 (8,5)	.885 (22,5)	.807 (20,5)	.472 (12)	.511 (13)	.571 (14,5)
50105N-8-1/4	5/16 (8)	1/4	.433 (11)	.885 (22,5)	.905 (23)	.472(12)	.629 (16)	.571 (14,5)
50105N-8-3/8	5/16 (8)	3/8	.472 (12)	.885 (22,5)	.905 (23)	.472(12)	.512 (13)	.571 (14,5)
50105N-10-1/4	10	1/4	.433 (11)	1.043 (26,5)	.984 (25)	.551 (14)	.748 (19)	.669 (17)
50105N-10-3/8	10	3/8	.472 (12)	1.043 (26,5)	1.102 (28)	.551 (14)	.748 (19)	.669 (17)
50105N-12-1/2	12	1/2	.590 (15)	1.240 (31,5)	1.358 (34,5)	.630 (16)	.944 (24)	.787 (20)

50115N

SWIVEL ELBOW

BSPP

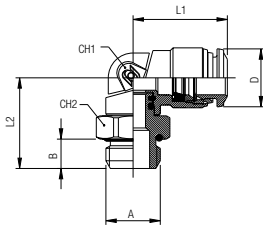

Part No.	Tube	A	B	L1	L2	CH1	CH2	D
50115N-3-M5	3	M5	.138 (3,5)	.650 (16,5)	.689 (17,5)	.354 (9)	.315 (8)	.394 (10)
50115N-4-M5	5/32 (4)	M5	.138 (3,5)	.709 (18)	.689 (17,5)	.354 (9)	.315 (8)	.394 (10)
50115N-4-1/8	5/32 (4)	1/8	.217 (5,5)	.709 (18)	.709 (18)	.354 (9)	.512 (13)	.394 (10)
50115N-4-1/4	5/32 (4)	1/4	.276 (7)	.709 (18)	.709 (18)	.354 (9)	.63 (16)	.394 (10)
50115N-5-M5	5	M5	.138 (3,5)	.787 (20)	.787 (20)	.433 (11)	.433 (11)	.492 (12,5)
50115N-5-1/8	5	1/8	.217 (5,5)	.787 (20)	.787 (20)	.433 (11)	.512 (13)	.492 (12,5)
50115N-6-M5	6	M5	.138 (3,5)	.827 (21)	.787 (20)	.433 (11)	.433 (11)	.492 (12,5)
50115N-6-1/8	6	1/8	.217 (5,5)	.827 (21)	.787 (20)	.433 (11)	.512 (13)	.492 (12,5)
50115N-6-1/4	6	1/4	.276 (7)	.827 (21)	.846 (21,5)	.433 (11)	.63 (16)	.492 (12,5)
50115N-6-3/8	6	3/8	.276 (7)	.846 (21,5)	.846 (21,5)	.433 (11)	.63 (16)	.492 (12,5)
50115N-8-1/8	5/16 (8)	1/8	.217 (5,5)	.886 (22,5)	.827 (21)	.472 (12)	.512 (13)	.571 (14,5)
50115N-8-1/4	5/16 (8)	1/4	.276 (7)	.886 (22,5)	.846 (21,5)	.472 (12)	.63 (16)	.571 (14,5)
50115N-8-3/8	5/16 (8)	3/8	.315 (8)	.886 (22,5)	.925 (23,5)	.472 (12)	.787 (20)	.571 (14,5)
50115N-8-1/2	5/16 (8)	1/2	.374 (9,5)	.886 (22,5)	.984 (25)	.472 (12)	.984 (25)	.571 (14,5)
50115N-10-1/4	10	1/4	.276 (7)	1.043 (26,5)	1.004 (25,5)	.551 (14)	.63 (16)	.689 (17,5)
50115N-10-3/8	10	3/8	.315 (8)	1.043 (26,5)	.984 (25)	.551 (14)	.787 (20)	.689 (17,5)
50115N-10-1/2	10	1/2	.374 (9,5)	1.043 (26,5)	1.043 (26,5)	.551 (14)	.984 (25)	.689 (17,5)
50115N-12-1/4	12	1/4	.276 (7)	1.201 (30,5)	1.142 (29)	.630 (16)	.630 (16)	.846 (21,5)
50115N-12-3/8	12	3/8	.315 (8)	1.240 (31,5)	1.063 (27)	.630 (16)	.787 (20)	.846 (21,5)
50115N-12-1/2	12	1/2	.374 (9,5)	1.240 (31,5)	1.122 (28,5)	.630 (16)	.984 (25)	.846 (21,5)
50115N-14-3/8	14	3/8	.315 (8)	1.240 (31,5)	1.083 (27,5)	.630 (16)	.787 (20)	.846 (21,5)
50115N-14-1/2	14	1/2	.374 (9,5)	1.240 (31,5)	1.142 (29)	.630 (16)	.984 (25)	.846 (21,5)
50115N-16-3/8	16	3/8	.315 (8)	1.299 (33)	1.575 (40)	.748 (19)	.984 (25)	.925 (23,5)
50115N-16-1/2	16	1/2	.374 (9,5)	1.299 (33)	1.634 (41,5)	.748 (19)	.984 (25)	.925 (23,5)
50115N-4-M6x1	4	M6x1	.138 (3,5)	.689 (17,5)	.709 (18)	.354 (9)	.315 (8)	.394 (10)
50115N-4-M8x1	4	M8x1	.217 (5,5)	.689 (17,5)	.709 (18)	.354 (9)	.472 (12)	.394 (10)
50115N-6-M10x1	6	M10x1	.276 (7)	.827 (21)	.846 (21,5)	.433 (11)	.512 (13)	.472 (12)
50115N-6-M12x1	6	M12x1	.295 (7,5)	.787 (20)	.866 (22)	.433 (11)	.63 (16)	.492 (12,5)
50115N-6-M12x1,25	6	M12x1,25	.295 (7,5)	.787 (20)	.866 (22)	.433 (11)	.63 (16)	.492 (12,5)
50115N-6-M12x1,5	6	M12x1,5	.295 (7,5)	.787 (20)	.866 (22)	.433 (11)	.63 (16)	.492 (12,5)
50115N-8-M12x1,5	8	M12x1,5	.295 (7,5)	.886 (22,5)	.866 (22)	.472 (12)	.63 (16)	.571 (14,5)

50125N

SWIVEL EXTENDED ELBOW

BSPP

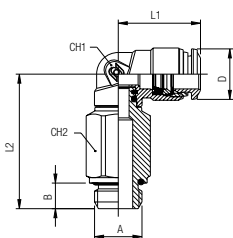

Part No.	Tube	A	B	L1	L2	CH1	CH2	D
50125N-4-1/8	5/32 (4)	1/8	.217 (5,5)	.709 (18)	1.181 (30)	.354 (9)	.472 (12)	.394 (10)
50125N-4-1/4	5/32 (4)	1/4	.276 (7)	.709 (18)	1.260 (32)	.354 (9)	.591 (15)	.394 (10)
50125N-5-1/8	5	1/8	.217 (5,5)	.787 (20)	1.358 (34,5)	.433 (11)	.472 (12)	.492 (12,5)
50125N-6-1/8	6	1/8	.217 (5,5)	.827 (21)	1.358 (34,5)	.433 (11)	.472 (12)	.492 (12,5)
50125N-6-1/4	6	1/4	.276 (7)	.827 (21)	1.417 (36)	.433 (11)	.591 (15)	.492 (12,5)
50125N-8-1/8	5/16 (8)	1/8	.197 (5)	.898 (22,8)	1.476 (37,5)	.472 (12)	.472 (12)	.571 (14,5)
50125N-8-1/4	5/16 (8)	1/4	.276 (7)	.886 (22,5)	1.496 (38)	.472 (12)	.591 (15)	.571 (14,5)
50125N-8-3/8	5/16 (8)	3/8	.315 (8)	.886 (22,5)	1.575 (40)	.472 (12)	.709 (18)	.571 (14,5)
50125N-10-1/4	10	1/4	.276 (7)	1.043 (26,5)	1.772 (45)	.551 (14)	.630 (16)	.689 (17,5)
50125N-10-3/8	10	3/8	.315 (8)	1.043 (26,5)	1.752 (44,5)	.551 (14)	.709 (18)	.689 (17,5)

50215N

SWIVEL BRANCH TEE

BSPP

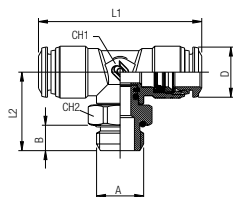

Part No.	Tube	A	B	L1	L2	CH1	CH2	D
50215N-3-M5	3	M5	.138 (3,5)	1.299 (33)	.669 (17)	.354 (9)	.315 (8)	.394 (10)
50215N-4-M5	5/32 (4)	M5	.138 (3,5)	1.339 (34)	.709 (18)	.354 (9)	.315 (8)	.394 (10)
50215N-4-1/8	5/32 (4)	1/8	.217 (5,5)	1.339 (34)	.728 (18,5)	.354 (9)	.512 (13)	.394 (10)
50215N-4-1/4	5/32 (4)	1/4	.276 (7)	1.339 (34)	.787 (20)	.354 (9)	.630 (16)	.394 (10)
50215N-5-M5	5	M5	.138 (3,5)	1.575 (40)	.807 (20,5)	.433 (11)	.433 (11)	.492 (12,5)
50215N-5-1/8	5	1/8	.217 (5,5)	1.575 (40)	.807 (20,5)	.433 (11)	.512 (13)	.492 (12,5)
50215N-6-M5	6	M5	.138 (3,5)	1.654 (42)	.807 (20,5)	.433 (11)	.433 (11)	.492 (12,5)
50215N-6-1/8	6	1/8	.217 (5,5)	1.654 (42)	.807 (20,5)	.433 (11)	.512 (13)	.492 (12,5)
50215N-6-1/4	6	1/4	.276 (7)	1.654 (42)	.866 (22)	.433 (11)	.630 (16)	.492 (12,5)
50215N-8-1/8	5/16 (8)	1/8	.217 (5,5)	1.772 (45)	.925 (23,5)	.512 (13)	.512 (13)	.571 (14,5)
50215N-8-1/4	5/16 (8)	1/4	.276 (7)	1.772 (45)	.945 (24)	.512 (13)	.630 (16)	.571 (14,5)
50215N-8-3/8	5/16 (8)	3/8	.315 (8)	1.772 (45)	1.024 (26)	.512 (13)	.787 (20)	.571 (14,5)
50215N-8-1/2	5/16 (8)	1/2	.374 (9,5)	1.772 (45)	1.083 (27,5)	.512 (13)	.984 (25)	.571 (14,5)
50215N-10-1/4	10	1/4	.276 (7)	2.087 (53)	1.083 (27,5)	.551 (14)	.630 (16)	.689 (17,5)
50215N-10-3/8	10	3/8	.315 (8)	2.087 (53)	1.063 (27)	.551 (14)	.787 (20)	.689 (17,5)
50215N-10-1/2	10	1/2	.374 (9,5)	2.087 (53)	1.122 (28,5)	.551 (14)	.984 (25)	.689 (17,5)
50215N-12-3/8	12	3/8	.315 (8)	2.461 (62,5)	1.161 (29,5)	.630 (16)	.787 (20)	.846 (21,5)
50215N-12-1/2	12	1/2	.374 (9,5)	2.461 (62,5)	1.220 (31)	.630 (16)	.984 (25)	.846 (21,5)
50215N-14-3/8	14	3/8	.315 (8)	2.461 (62,5)	1.161 (29,5)	.630 (16)	.787 (20)	.846 (21,5)
50215N-14-1/2	14	1/2	.374 (9,5)	2.461 (62,5)	1.220 (31)	.630 (16)	.984 (25)	.846 (21,5)
50215N-16-3/8	16	3/8	.315 (8)	2.578 (65,5)	1.575 (40)	.748 (19)	.984 (25)	.925 (23,5)
50215N-16-1/2	16	1/2	.374 (9,5)	2.578 (65,5)	1.634 (41,5)	.748 (19)	.984 (25)	.925 (23,5)
50215N-6-M12x1	6	M12x1	.295 (7,5)	1.654 (42)	.866 (22)	.433 (11)	.630 (16)	.492 (12,5)
50215N-6-M12x1,25	6	M12x1,25	.295 (7,5)	1.654 (42)	.866 (22)	.433 (11)	.630 (16)	.492 (12,5)
50215N-6-M12x1,5	6	M12x1,5	.295 (7,5)	1.654 (42)	.866 (22)	.433 (11)	.630 (16)	.492 (12,5)

50225N

SWIVEL RUN TEE

BSPP

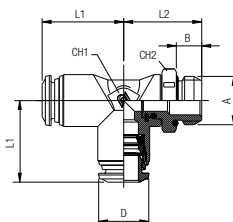

Part No.	Tube	A	B	L1	L2	CH1	CH2	D
50225N-3-M5	3	M5	.138 (3,5)	.650 (16,5)	.669 (17)	.354 (9)	.315 (8)	.394 (10)
50225N-4-M5	5/32 (4)	M5	.138 (3,5)	.669 (17)	.709 (18)	.354 (9)	.315 (8)	.394 (10)
50225N-4-1/8	5/32 (4)	1/8	.217 (5,5)	.669 (17)	.728 (18,5)	.354 (9)	.512 (13)	.394 (10)
50225N-4-1/4	5/32 (4)	1/4	.276 (7)	.669 (17)	.787 (20)	.354 (9)	.63 (16)	.394 (10)
50225N-5-M5	5	M5	.138 (3,5)	.787 (20)	.807 (20,5)	.433 (11)	.433 (11)	.492 (12,5)
50225N-5-1/8	5	1/8	.217 (5,5)	.787 (20)	.807 (20,5)	.433 (11)	.512 (13)	.492 (12,5)
50225N-6-M5	6	M5	.138 (3,5)	.827 (21)	.807 (20,5)	.433 (11)	.433 (11)	.492 (12,5)
50225N-6-1/8	6	1/8	.217 (5,5)	.827 (21)	.807 (20,5)	.433 (11)	.512 (13)	.492 (12,5)
50225N-6-1/4	6	1/4	.276 (7)	.827 (21)	.866 (22)	.433 (11)	.63 (16)	.492 (12,5)
50225N-8-1/8	5/16 (8)	1/8	.217 (5,5)	.886 (22,5)	.886 (22,5)	.512 (13)	.512 (13)	.571 (14,5)
50225N-8-1/4	5/16 (8)	1/4	.276 (7)	.886 (22,5)	.906 (23)	.512 (13)	.63 (16)	.571 (14,5)
50225N-8-3/8	5/16 (8)	3/8	.315 (8)	.886 (22,5)	.984 (25)	.512 (13)	.787 (20)	.571 (14,5)
50225N-8-1/2	5/16 (8)	1/2	.374 (9,5)	.886 (22,5)	1.043 (26,5)	.512 (13)	.984 (25)	.571 (14,5)
50225N-10-1/4	10	1/4	.276 (7)	1.043 (26,5)	1.063 (27)	.551 (14)	.63 (16)	.689 (17,5)
50225N-10-3/8	10	3/8	.315 (8)	1.043 (26,5)	1.043 (26,5)	.551 (14)	.787 (20)	.689 (17,5)
50225N-10-1/2	10	1/2	.374 (9,5)	1.043 (26,5)	1.102 (28)	.551 (14)	.984 (25)	.689 (17,5)
50225N-12-3/8	12	3/8	.315 (8)	1.240 (31,5)	1.161 (29,5)	.63 (16)	.787 (20)	.846 (21,5)
50225N-12-1/2	12	1/2	.374 (9,5)	1.240 (31,5)	1.220 (31)	.63 (16)	.984 (25)	.846 (21,5)
50225N-6-M12x1	6	M12x1	.295 (7,5)	.827 (21)	.866 (22)	.433 (11)	.63 (16)	.492 (12,5)
50225N-6-M12x1,25	6	M12x1,25	.295 (7,5)	.827 (21)	.866 (22)	.433 (11)	.63 (16)	.492 (12,5)
50225N-6-M12x1,5	6	M12x1,5	.295 (7,5)	.827 (21)	.866 (22)	.433 (11)	.63 (16)	.492 (12,5)

50326N

Y-CONNECTOR MALE ADAPTOR (PARALLEL)

BSPP

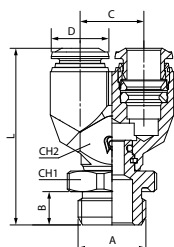

Part No.	Tube	A	B	C	CH1	CH2	D
50326N-4-1/8	5/32 (4)	1/8	.217 (5,5)	1.280 (32,5)	.511 (13)	.433 (11)	.394 (10)
50326N-6-1/8	6	1/8	.217 (5,5)	1.456 (37)	.511 (13)	.511 (13)	.492 (12,5)
50326N-6-1/4	6	1/4	.275 (7)	1.516 (38,5)	.629 (16)	.511 (13)	.492 (12,5)
50326N-8-1/8	5/16 (8)	1/8	.217 (5,5)	1.594 (40,5)	.511 (13)	.590 (15)	.551 (14)
50326N-8-1/4	5/16 (8)	1/4	.275 (7)	1.614 (41)	.629 (16)	.590 (15)	.551 (14)
50326N-8-3/8	5/16 (8)	3/8	.314 (8)	1.693 (43)	.787 (20)	.590 (15)	.551 (14)

50100N

FIXED ELBOW

BSPT

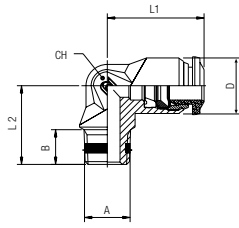

Part No.	Tube	A	B	L1	L2	CH	D
50100N-4-M5	5/32 (4)	M5	.197 (5)	.669 (17)	.591 (15)	.354 (9)	.394 (10)
50100N-4-1/8	5/32 (4)	1/8	.295 (7,5)	.669 (17)	.61 (15,5)	.354 (9)	.394 (10)
50100N-5-M5	5	M5	.197 (5)	.787 (20)	.669 (17)	.433 (11)	.492 (12,5)
50100N-5-1/8	5	1/8	.295 (7,5)	.787 (20)	.689 (17,5)	.433 (11)	.492 (12,5)
50100N-6-1/8	6	1/8	.295 (7,5)	.827 (21)	.689 (17,5)	.433 (11)	.492 (12,5)
50100N-6-1/4	6	1/4	.433 (11)	.827 (21)	.846 (21,5)	.433 (11)	.492 (12,5)
50100N-8-1/8	5/16 (8)	1/8	.295 (7,5)	.886 (22,5)	.748 (19)	.512 (13)	.551 (14)
50100N-8-1/4	5/16 (8)	1/4	.433 (11)	.886 (22,5)	.846 (21,5)	.512 (13)	.551 (14)
50100N-10-1/4	10	1/4	.433 (11)	1.043 (26,5)	.965 (24,5)	.63 (16)	.669 (17)
50100N-10-3/8	10	3/8	.453 (11,5)	1.043 (26,5)	.945 (24)	.63 (16)	.669 (17)
50100N-12-1/4	12	1/4	.433 (11)	1.201 (30,5)	1.201 (28)	.748 (19)	.846 (21,5)
50100N-12-3/8	12	3/8	.453 (11,5)	1.201 (30,5)	1.201 (28)	.748 (19)	.846 (21,5)

50200N

FIXED BRANCH TEE

BSPT

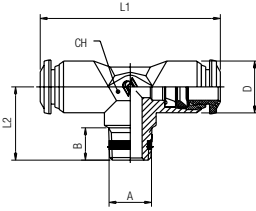

Part No.	Tube	A	B	L1	L2	CH	D
50200N-4-M5	5/32 (4)	M5	.197 (5)	1.339 (34)	.591 (15)	.354 (9)	.394 (10)
50200N-4-1/8	5/32 (4)	1/8	.295 (7,5)	1.339 (34)	.61 (15,5)	.354 (9)	.394 (10)
50200N-5-1/8	5	1/8	.295 (7,5)	1.575 (40)	.689 (17,5)	.433 (11)	.492 (12,5)
50200N-6-1/8	6	1/8	.295 (7,5)	1.654 (42)	.689 (17,5)	.433 (11)	.492 (12,5)
50200N-8-1/8	5/16 (8)	1/8	.295 (7,5)	1.772 (45)	.748 (19)	.512 (13)	.551 (14)
50200N-8-1/4	5/16 (8)	1/4	.433 (11)	1.772 (45)	.846 (21,5)	.512 (13)	.551 (14)
50200N-10-1/4	10	1/4	.433 (11)	2.087 (53)	.965 (24,5)	.630 (16)	.669 (17)
50200N-10-3/8	10	3/8	.453 (11,5)	2.087 (53)	.945 (24)	.63 (16)	.669 (17)
50200N-12-1/4	12	1/4	.433 (11)	2.402 (61)	1.102 (28)	.748 (19)	.846 (21,5)
50200N-12-3/8	12	3/8	.453 (11,5)	2.402 (61)	1.102 (28)	.748 (19)	.846 (21,5)

50040N

UNION

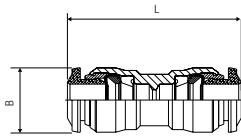

Part No.	Tube	Tube	L	B
50040N-3	3	3	1.024 (26)	.335 (8,5)
50040N-4	5/32 (4)	5/32 (4)	1.200 (30,5)	.413 (10,5)
50040N-5	5	5	1.299 (33)	.453 (11,5)
50040N-6-4	6	5/32 (4)	1.259 (32)	.492 (12,5)
50040N-6	6	6	1.338 (34)	.492 (12,5)
50040N-8-6	5/16 (8)	6	1.377 (35)	.571 (14,5)
50040N-8	5/16 (8)	5/16 (8)	1.417 (36)	.571 (14,5)
50040N-10-8	10	5/16 (8)	1.594 (40,5)	.689 (17,5)
50040N-10	10	10	1.653 (42)	.689 (17,5)
50040N-12-10	12	10	1.791 (45,5)	.807 (20,5)
50040N-12	12	12	1.850 (47)	.807 (20,5)
50040N-14	14	14	1.929 (49)	.846 (21,5)
50040N-16	16	16	2.107 (53,5)	.925 (23,5)

50050N

BULKHEAD UNION

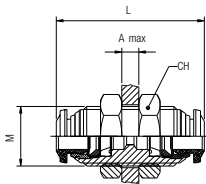

Part No.	Tube	M	L	CH	A max
50050N-3	3	M10x1	1.024 (26)	.551 (14)	.197 (5)
50050N-4	5/32 (4)	M12x1	1.240 (31,5)	.669 (17)	.275 (7)
50050N-5	5	M14x1	1.299 (33)	.669 (17)	.275 (7)
50050N-6	6	M14x1	1.377 (35)	.669 (17)	.374 (9,5)
50050N-8-6	5/16 (8)-6	M16x1	1.456 (37)	.748 (19)	.413 (10,5)
50050N-8	5/16 (8)	M16x1	1.456 (37)	.748 (19)	.413 (10,5)
50050N-10-6	10-6	M20x1	1.693 (43)	.944 (24)	.453 (11,5)
50050N-10-8	10-5/16 (8)	M20x1	1.693 (43)	.944 (24)	.492 (12,5)
50050N-10	10	M20x1	1.692 (42)	.944 (24)	.492 (12,5)
50050N-12	12	M22x1	1.889 (48)	1.023 (26)	.649 (16,5)
50050N-14	14	M23x1	1.929 (49)	1.063 (26)	.649 (16,5)

50055N

FEMALE BULKHEAD CONNECTOR

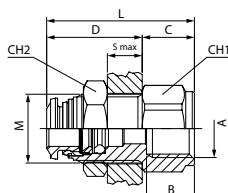

Part No.	Tube	A	B	M	S max	CH1	CH2	C	D	L
50055N-4-1/8	5/32 (4)	1/8	.334 (8,5)	M12X1	.275 (7)	.591 (15)	.669 (17)	.394 (10)	.748 (19)	1.141 (31)
50055N-6-1/8	6	1/8	.334 (8,5)	M14X1	.315 (8)	.630 (16)	.669 (17)	.394 (10)	.826 (21)	1.221 (31)
50055N-6-1/4	6	1/4	.433 (11)	M14X1	.315 (8)	.630 (16)	.669 (17)	.472 (12)	.826 (21)	1.300 (33)
50055N-8-1/8	5/16 (8)	1/8	.334 (8,5)	M16X1	.315 (8)	.709 (18)	.748 (19)	.394 (10)	.866 (22)	1.260 (32)
50055N-8-1/4	5/16 (8)	1/4	.433 (11)	M16X1	.315 (8)	.709 (18)	.748 (19)	.472 (12)	.866 (22)	1.339 (34)
50055N-10-3/8	10	3/8	.472 (12)	M20X1	.374 (9,5)	.945 (24)	.945 (24)	.551 (14)	1.003 (25,5)	1.556 (38,5)
50055N-12-3/8	12	3/8	.472 (12)	M22X1	.413 (10,5)	.945 (24)	1.024 (26)	.591 (15)	1.083 (27,5)	1.673 (42,5)
50055N-12-1/2	12	1/2	.591 (15)	M22X1	.413 (10,5)	.945 (24)	1.024 (26)	.669 (17)	1.083 (27,5)	1.752 (44,5)

50465N

BULKHEAD CONNECTOR

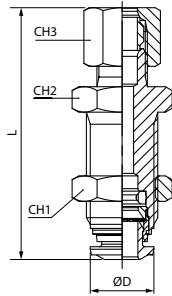

Part No.	Tube	L	D	CH1	CH2	CH3
50465N-6	6	1.949 (49,5)	.492 (12,5)	.511 (13)	.669 (17)	.669 (17)
50465N-8	5/16 (8)	2.047 (52)	.551 (14)	.551 (14)	.748 (19)	.748 (19)
50465N-10	10	2.282 (59)	.669 (17)	.748 (19)	.945 (24)	.945 (24)

50130N

UNION ELBOW

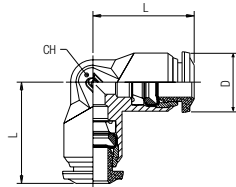

Part No.	Tube	L	CH	D
50130N-3	3	.669 (17)	.354 (9)	.394 (10)
50130N-4	5/32 (4)	.669 (17)	.354 (9)	.394 (10)
50130N-5	5	.787 (20)	.433 (11)	.492 (12,5)
50130N-6	6	.826 (21)	.433 (11)	.492 (12,5)
50130N-8	5/16 (8)	.885 (22,5)	.511 (13)	.571 (14,5)
50130N-10	10	1.043 (26,5)	.629 (16)	.689 (17,5)
50130N-12	12	1.200 (30,5)	.748 (19)	.846 (21,5)
50130N-14	14	1.279 (32,5)	.748 (19)	.846 (21,5)
50130N-16	16	1.299 (33)	.748 (19)	.925 (23,5)

50310N

UNION Y

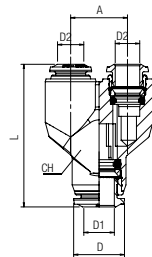

Part No.	Tube	A	L	CH	D
50310N-3	3	.394 (10)	1.142 (29)	.433 (11)	.394 (10)
50310N-4	5/32 (4)	.433 (11)	1.259 (32)	.433 (11)	.394 (10)
50310N-5	5	.531 (13,5)	1.377 (35)	.511 (13)	.492 (12,5)
50310N-6	6	.531 (13,5)	1.437 (36,5)	.511 (13)	.492 (12,5)
50310N-8	5/16 (8)	.610 (15,5)	1.614 (41)	.590 (15)	.551 (14)
50310N-10	10	.728 (18,5)	1.889 (48)	.708 (18)	.669 (17)

50230N

UNION TEE

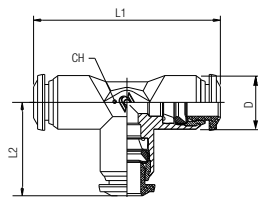

Part No.	Tube	L1	L2	CH	D
50230N-3	3	1.338 (34)	.669 (17)	.354 (9)	.394 (10)
50230N-4	5/32 (4)	1.338 (34)	.669 (17)	.354 (9)	.394 (10)
50230N-5	5	1.574 (40)	.787 (20)	.433 (11)	.492 (12,5)
50230N-6	6	1.653 (42)	.826 (21)	.433 (11)	.492 (12,5)
50230N-8	5/16 (8)	1.771 (45)	.885 (22,5)	.511 (13)	.551 (14)
50230N-10	10	2.086 (53)	1.043 (26,5)	.629 (16)	.669 (17)
50230N-12	12	2.401 (61)	1.200 (30,5)	.748 (19)	.847 (21,5)
50230N-14	14	2.578 (65,5)	1.279 (32,5)	.748 (19)	.847 (21,5)
50230N-16	16	2.578 (65,5)	1.299 (33)	.748 (19)	.925 (23,5)

50500N

SINGLE BANJO BODY

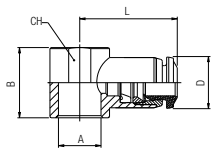

Part No.	Tube	A	B	L	CH	D
50500N-3-M5	3	M5	.492 (12,5)	.748 (19)	-	.394 (10)
50500N-3-M6	3	M6	.492 (12,5)	.748 (19)	-	.394 (10)
50500N-4-M5	5/32 (4)	M5	.492 (12,5)	.748 (19)	-	.394 (10)
50500N-4-M6	5/32 (4)	M6	.492 (12,5)	.748 (19)	-	.394 (10)
50500N-4-1/8	5/32 (4)	1/8	.591 (15)	.827 (21)	.551 (14)	.394 (10)
50500N-5-M5	5	M5	.492 (12,5)	.787 (20)	-	.492 (12,5)
50500N-5-M6	5	M6	.492 (12,5)	.787 (20)	-	.492 (12,5)
50500N-5-1/8	5	1/8	.591 (15)	.846 (21,5)	.551 (14)	.492 (12,5)
50500N-5-1/4	5	1/4	.669 (17)	.965 (24,5)	.709 (18)	.492 (12,5)
50500N-6-M5	6	M5	.492 (12,5)	.807 (20,5)	-	.492 (12,5)
50500N-6-M6	6	M6	.492 (12,5)	.807 (20,5)	-	.492 (12,5)
50500N-6-1/8	6	1/8	.591 (15)	.866 (22)	.551 (14)	.492 (12,5)
50500N-6-1/4	6	1/4	.669 (17)	.984 (25)	.709 (18)	.492 (12,5)
50500N-8-1/8	5/16 (8)	1/8	.591 (15)	.945 (24)	.551 (14)	.551 (14)
50500N-8-1/4	5/16 (8)	1/4	.669 (17)	1.024 (26)	.709 (18)	.551 (14)
50500N-8-3/8	5/16 (8)	3/8	.787 (20)	1.102 (28)	.827 (21)	.551 (14)
50500N-10-1/4	10	1/4	.669 (17)	1.142 (29)	.709 (18)	.669 (17)
50500N-10-3/8	10	3/8	.787 (20)	1.201 (30,5)	.827 (21)	.669 (17)
50500N-12-3/8	12	3/8	.787 (20)	1.280 (32,5)	.827 (21)	.846 (21,5)
50500N-12-1/2	12	1/2	.945 (24)	1.378 (35)	.984 (25)	.846 (21,5)
50500N-14-1/2	14	1/2	.945 (24)	1.398 (35,5)	.984 (25)	.846 (21,5)

For BANJO STEM assemblies see 10.7/10.8/10.9

50510N

DOUBLE BANJO BODY

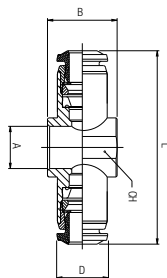

Part No.	Tube	A	B	L	CH	D
50510N-4-M5	5/32 (4)	M5	.492 (12,5)	1.496 (38)	-	.394 (10)
50510N-4-M6	5/32 (4)	M6	.492 (12,5)	1.496 (38)	-	.394 (10)
50510N-4-1/8	5/32 (4)	1/8	.591 (15)	1.654 (42)	.551 (14)	.394 (10)
50510N-5-1/8	5	1/8	.591 (15)	1.693 (43)	.551 (14)	.492 (12,5)
50510N-5-1/4	5	1/4	.669 (17)	1.929 (49)	.709 (18)	.492 (12,5)
50510N-6-1/8	6	1/8	.591 (15)	1.732 (44)	.551 (14)	.492 (12,5)
50510N-6-1/4	6	1/4	.669 (17)	1.969 (50)	.709 (18)	.492 (12,5)
50510N-8-1/8	5/16 (8)	1/8	.591 (15)	1.890 (48)	.551 (14)	.551 (14)
50510N-8-1/4	5/16 (8)	1/4	.669 (17)	2.047 (52)	.709 (18)	.551 (14)

For BANJO STEM assemblies see 10.7/10.8/10.9

50600

STANDPIPE

BSPP

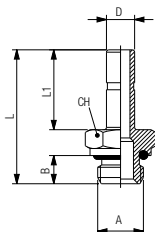

Part No.	D	A	B	L	L1	CH
50600-4-M5	5/32 (4)	M5	.157 (4)	.945 (24)	.591 (15)	.315 (8)
50600-4-1/8	5/32 (4)	1/8	.236 (6)	1.043 (26,5)	.591 (15)	.512 (13)
50600-5-M5	5	M5	.157 (4)	1.024 (26)	.669 (17)	.315 (8)
50600-5-1/8	5	1/8	.236 (6)	1.122 (28,5)	.669 (17)	.512 (13)
50600-5-1/4	5	1/4	.315 (8)	1.220 (31)	.669 (17)	.630 (16)
50600-6-M5	6	M5	.157 (4)	1.024 (26)	.669 (17)	.315 (8)
50600-6-1/8	6	1/8	.236 (6)	1.122 (28,5)	.669 (17)	.512 (13)
50600-6-1/4	6	1/4	.315 (8)	1.220 (31)	.669 (17)	.630 (16)
50600-8-1/8	5/16 (8)	1/8	.236 (6)	1.161 (29,5)	.709 (18)	.512 (13)
50600-8-1/4	5/16 (8)	1/4	.315 (8)	1.260 (32)	.709 (18)	.630 (16)
50600-8-3/8	5/16 (8)	3/8	.354 (9)	1.319 (33,5)	.709 (18)	.787 (20)
50600-10-1/8	10	1/8	.236 (6)	1.319 (33,5)	.866 (22)	.512 (13)
50600-10-1/4	10	1/4	.315 (8)	1.417 (36)	.866 (22)	.630 (16)
50600-10-3/8	10	3/8	.354 (9)	1.476 (37,5)	.866 (22)	.787 (20)
50600-10-1/2	10	1/2	.394 (10)	1.555 (39,5)	.866 (22)	.945 (24)
50600-12-1/4	12	1/4	.315 (8)	1.516 (38,5)	.965 (24,5)	.630 (16)
50600-12-3/8	12	3/8	.354 (9)	1.575 (40)	.965 (24,5)	.787 (20)
50600-14-1/2	14	1/2	.394 (10)	1.732 (44)	1.043 (26,5)	.945 (24)

50610

POLYAMIDE PLUG

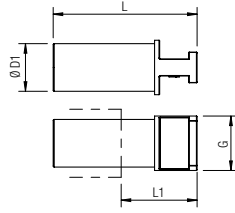

Part No.	ØD1	G	L	L1
50610-3	3	.197 (5)	1.201 (30,5)	.709 (18)
50610-4	5/32 (4)	.236 (6)	1.162 (29,5)	.611 (15,5)
50610-5	5	.276 (7)	1.319 (33,5)	.709 (18)
50610-6	6	.315 (8)	1.260 (32)	.611 (15,5)
50610-8	5/16 (8)	.394 (10)	1.398 (35,5)	.768 (19,5)
50610-10	10	.472 (12)	1.575 (40)	.768 (19,5)
50610-12	12	.551 (14)	1.634 (41,5)	.787 (20)
50610-14	14	.630 (16)	1.654 (42)	.768 (19,5)
50610-16	16	.709 (18)	1.772 (45)	.807 (21)

50625

DOUBLE JOINT

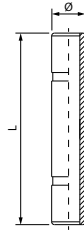

Part No.	Tube	L
50625-4	5/32 (4)	1.220 (31)
50625-5	5	1.299 (33)
50625-6	6	1.339 (34)
50625-8	5/16 (8)	1.417 (36)
50625-10	10	1.772 (45)
50625-12	12	1.969 (50)

50700N

TUBE REDUCER

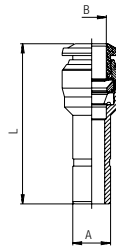

Part No.	A	B	L	D
50700N-4-3	5/32 (4)	3	1.181 (30)	.335 (8,5)
50700N-5-4	5	5/32 (4)	1.260 (32)	.453 (11,5)
50700N-6-4	6	5/32 (4)	1.181 (30)	.413 (10,5)
50700N-6-5	6	5	1.358 (34,5)	.453 (11,5)
50700N-8-4	5/16 (8)	5/32 (4)	1.280 (32,5)	.413 (10,5)
50700N-8-6	5/16 (8)	6	1.358 (34,5)	.492 (12,5)
50700N-10-4	10	5/32 (4)	1.240 (31,5)	.413 (10,5)
50700N-10-6	10	6	1.476 (37,5)	.492 (12,5)
50700N-10-8	10	5/16 (8)	1.516 (38,5)	.571 (14,5)
50700N-12-8	12	5/16 (8)	1.555 (39,5)	.571 (14,5)
50700N-12-10	12	10	1.693 (43)	.689 (17,5)

50900N

5 WAY ALUMINUM MANIFOLD

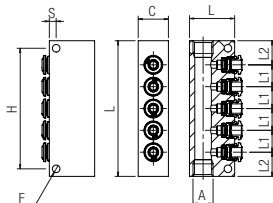

Part No.	Tube	A	H	F	S	C	D	L	L1	L2
50900N-4-1/8	5/32 (4)	1/8	2.224 (66)	.197 (5)	.177 (4,5)	.591 (15)	.984 (25)	2.953 (75)	.472 (12)	.531 (13,5)
50900N-6-1/8	6	1/8	3.150 (80)	.197 (5)	.177 (4,5)	.591 (15)	.984 (25)	3.543 (90)	.571 (14,5)	.630 (16)
50900N-6-1/4	6	1/4	3.150 (80)	.197 (5)	.177 (4,5)	.787 (20)	1.181 (30)	3.543 (90)	.571 (14,5)	.630 (16)
50900N-8-1/4	5/16 (8)	1/4	3.543 (90)	.197 (5)	.177 (4,5)	.787 (20)	1.181 (30)	3.937 (100)	.630 (16)	.709 (18)

55800N

PUSH-FIT CARTRIDGES

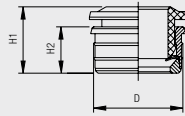

Part No.	Tube	H1	H2	D
55800N-3	3	.370 (9,4)	.197 (5)	.264 (6,7)
55800N-4	5/32 (4)	.429 (10,9)	.220 (5,6)	.343 (8,7)
55800N-5	5	.508 (12,9)	.272 (6,9)	.423 (10,75)
55800N-6	6	.512 (13)	.270 (6,85)	.500 (12,7)
55800N-8	5/16 (8)	.618 (15,7)	.335 (8,5)	.618 (15,7)
55800N-10	10	.697 (17,7)	.374 (9,5)	.720 (18,3)
55800N-12	12	.721 (18,3)	.701 (17,8)	.374 (9,5)

SEAT

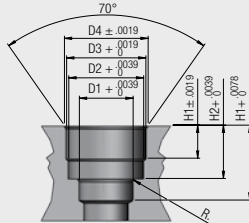

Seats dimensions push-fit cartridges.

Tube	D1	D2	D3	D4	H1	H2	H3	R
1/8 (3)	.134 (3,4)	.238 (6,05)	.252 (6,4)	.274 (6,96)	.146 (3,7)	.240 (6,1)	.339 (8,6)	.020 (0,5)
5/32 (4)	.165 (4,2)	.293 (7,45)	.331 (8,4)	.354 (9)	.148 (3,76)	.256 (6,5)	.374 (9,5)	.020 (0,5)
1/5 (5)	.205 (5,2)	.329 (8,36)	.370 (9,4)	.400 (10,16)	.175 (4,45)	.311 (7,9)	.413 (10,5)	.020 (0,5)
1/4 (6)	.244 (6,2)	.368 (9,35)	.411 (10,44)	.447 (11,35)	.197 (5)	.335 (8,5)	.453 (11,5)	.020 (0,5)
5/16 (8)	.323 (8,2)	.449 (11,4)	.488 (12,4)	.508 (12,9)	.205 (5,2)	.335 (8,5)	.492 (12,5)	.030 (0,76)
3/8 (10)	.402 (10,2)	.571 (14,5)	.606 (15,4)	.630 (16)	.264 (6,7)	.413 (10,5)	.591 (15)	.030 (0,76)
1/2 (12)	.480 (12,2)	.669 (17)	.709 (18)	.748 (19)	.295 (7,5)	.476 (12,1)	.669 (17)	.039 (1)

55801

TOOL FOR PUSH-FIT CARTRIDGES SEAT



Part No.	Tube	ø Body
55801-3	3	.394 (10)
55801-4	4 (5/32)	.394 (10)
55801-6	6 (1/4)	.472 (12)
55801-8	8 (5/16)	.472 (12)
55801-10	10 (3/8)	.630 (16)
55801-12	12 (1/2)	.630 (16)

55802

ASSEMBLING TOOL FOR PUSH-FIT CARTRIDGES



Part No.	Tube
55802-3	3
55802-4	4 (5/32)
55802-6	6 (1/4)
55802-8	8 (5/16)
55802-10	10 (3/8)
55802-12	12 (1/2)

PUSH-FIT CARTRIDGES ASSEMBLING INSTRUCTIONS ART. 55800N

1 Make the seat for the cartridge utilizing the suitable tool Art. 55801.



2 Insert the lip seal inside of the seat.



3 Insert the cartridge into the assembling tool Art. 55802.



4 Press the cartridge inside of the seat until it will be reached the abutment surface with the assembling tool.



50980
SECURITY CLIPS

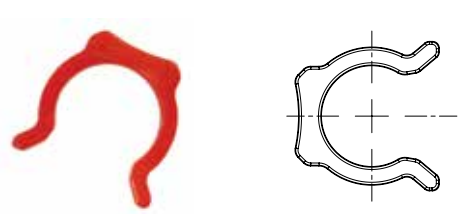

Part No.	Tube
50980-53	5/32 (4)
50980-5	3/16 (5)
50980-04	1/4 (6)
50980-05	5/16 (8)
50980-06	3/8 (10)
50980-08	1/2 (12)
50980-14	(14)

50991
TOOL FOR DISASSEMBLING

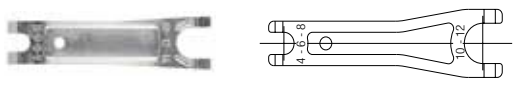

Part No.
50991

50006
THREAD PACKING FOR THE SWIFFIT TAPER THREADS



Part No.	Thread
50006-02	1/8
50006-04	1/4
50006-06	3/8
50006-08	1/2

FITTING KITS
50861N-4
FITTING KIT - 4MM TUBE

Part No.	Description	Qty
50000N-4-1/8	Straight 4mm Tube x 1/8 Male	5
50000N-4-1/4	Straight 4mm Tube x 1/4 Male	5
50110N-4-1/8	Swivel Elbow 4mm Tube x 1/8 Male	5
50110N-4-1/4	Swivel Elbow 4mm Tube x 1/4 Male	5
50210N-4-1/8	Branch Tee 4mm Tube x 1/8 Male	5
50210N-4-1/4	Branch Tee 4mm Tube x 1/4 Male	5
50222N-4-1/8	Run Tee 4mm Tube x 1/8 Male	5
50222N-4-1/4	Run Tee 4mm Tube x 1/4 Male	5
50040N-4	Union 4mm Tube	5
50050N-4	Bulkhead Union 4mm Tube	5
50130N-4	Union Elbow 4mm Tube	5
50230N-4	Union Tee 4mm Tube	5

50861N-6
FITTING KIT - 6MM TUBE

Part No.	Description	Qty
50000N-6-1/8	Straight 6mm Tube x 1/8 Male	5
50000N-6-1/4	Straight 6mm Tube x 1/4 Male	5
50110N-6-1/8	Swivel Elbow 6mm Tube x 1/8 Male	5
50110N-6-1/4	Swivel Elbow 6mm Tube x 1/4 Male	5
50210N-6-1/8	Branch Tee 6mm Tube x 1/8 Male	5
50210N-6-1/4	Branch Tee 6mm Tube x 1/4 Male	5
50222N-6-1/8	Run Tee 6mm Tube x 1/8 Male	5
50222N-6-1/4	Run Tee 6mm Tube x 1/4 Male	5
50040N-6	Union 6mm Tube	5
50050N-6	Bulkhead Union 6mm Tube	5
50130N-6	Union Elbow 6mm Tube	5
50230N-6	Union Tee 6mm Tube	5

50861N-8
FITTING KIT - 8MM TUBE

Part No.	Description	Qty
50000N-8-1/8	Straight 8mm Tube x 1/8 Male	5
50000N-8-1/4	Straight 8mm Tube x 1/4 Male	5
50000N-8-3/8	Straight 8mm Tube x 3/8 Male	5
50110N-8-1/8	Swivel Elbow 8mm Tube x 1/8 Male	5
50110N-8-1/4	Swivel Elbow 8mm Tube x 1/4 Male	5
50110N-8-3/8	Swivel Elbow 8mm Tube x 3/8 Male	5
50210N-8-1/8	Branch Tee 8mm Tube x 1/8 Male	5
50210N-8-1/4	Branch Tee 8mm Tube x 1/4 Male	5
50040N-8	Union 8mm Tube	5
50050N-8	Bulkhead Union 8mm Tube	5
50130N-8	Union Elbow 8mm Tube	5
50230N-8	Union Tee 8mm Tube	5

50861N-10

FITTING KIT - 10MM TUBE



Part No.	Description	Qty
50000N-10-1/4	Straight 10mm Tube x 1/4 Male	3
50000N-10-3/8	Straight 10mm Tube x 3/8 Male	3
50110N-10-1/4	Swivel Elbow 10mm Tube x 1/4 Male	3
50110N-10-3/8	Swivel Elbow 10mm Tube x 3/8 Male	3
50210N-10-1/4	Branch Tee 10mm Tube x 1/4 Male	3
50210N-10-3/8	Branch Tee 10mm Tube x 3/8 Male	3
50222N-10-1/4	Run Tee 10mm Tube x 1/4 Male	3
50222N-10-3/8	Run Tee 10mm Tube x 3/8 Male	3
50040N-10	Union 10mm Tube	3
50050N-10	Bulkhead Union 10mm Tube	3
50130N-10	Union Elbow 10mm Tube	3
50230N-10	Union Tee 10mm Tube	3

50861N-12

FITTING KIT - 12MM TUBE



Part No.	Description	Qty
50000N-12-3/8	Straight 12mm Tube x 3/8 Male	3
50000N-12-1/2	Straight 12mm Tube x 1/2 Male	3
50110N-12-3/8	Swivel Elbow 12mm Tube x 3/8 Male	3
50110N-12-1/2	Swivel Elbow 12mm Tube x 1/2 Male	3
50210N-12-3/8	Branch Tee 12mm Tube x 3/8 Male	3
50210N-12-1/2	Branch Tee 12mm Tube x 1/2 Male	3
50222N-12-3/8	Run Tee 12mm Tube x 3/8 Male	3
50222N-12-1/2	Run Tee 12mm Tube x 1/2 Male	3
50040N-12	Union 12mm Tube	3
50050N-12	Bulkhead Union 12mm Tube	3
50130N-12	Union Elbow 12mm Tube	3
50230N-12	Union Tee 12mm Tube	3